

CSAL 25 RS

EN INSTALLATION INSTRUCTIONS

RIELLO

CONFORMITY

Solar collectors conform to EN 12975 standard and to Solar Keymark certification standard.

 This product must only be used for the purpose for which it is designed and made, as specified by **RIELLO**. **RIELLO** declines all responsibility, contractual or other, for damage to property or injury to persons or animals caused by improper installation, adjustment, maintenance or use.

RANGE

MODEL	CODE
CSAL 25 RS	20094516
CSAL 25 RS (Pack of 2)	20094517
CSAL 25 RS (Pack of 3)	20094518
CSAL 25 RS (Pack of 5)	20094519
CSAL 25 RS (Pack of 10)	20094520

CONTENTS

1	System layout	3
2	Identification	3
3	Technical specifications	4
4	Connections	5
5	Water circuit	6
6	Unpacking the product	7
7	Handling	7
8	Installation	8
9	Filling the circuit	9
10	Checks	10
11	Maintenance	10

The following symbols are used in this manual:

 **CAUTION!** = Identifies actions that require caution and adequate preparation.

 **STOP!** = Identifies actions that you **MUST NOT** do.

This manual, Code 20094589 – Rev. 3 (02/2016) comprises 12 pages.

1 SYSTEM LAYOUT

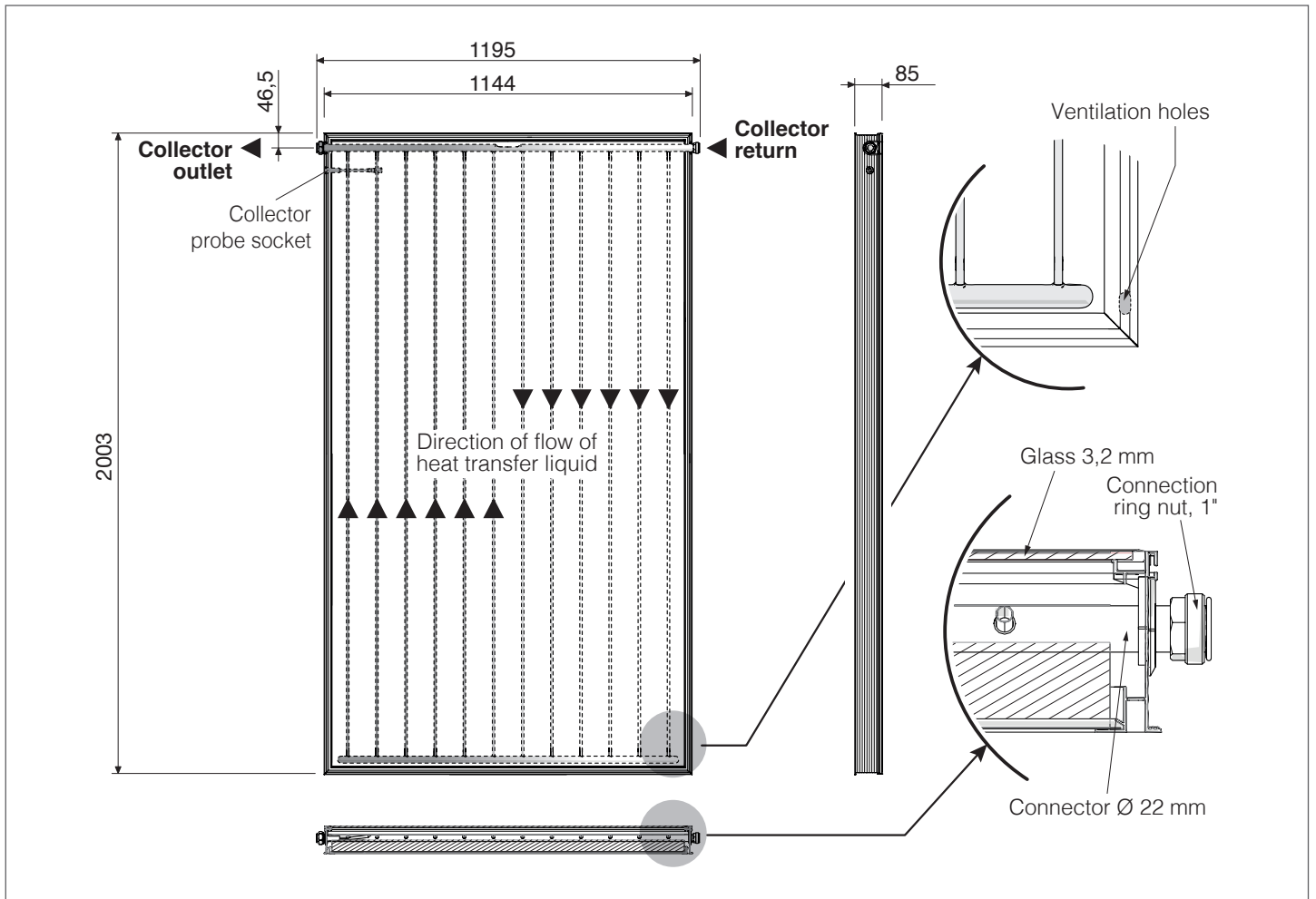

2 IDENTIFICATION

Data label
To be applied to the back of the solar collector on installation

RIELLO	RIELLO S.p.A.
Via Ing. Placido Riello 7 - 37045 Legnago (VR) - Italia	
Codice
Modello
Manicoba
COLLETTORE SOLARE (neutro)	
Codice
Tipo
Dimensioni
Superficie lorda
Superficie di apertura
Superficie assorbitore
Peso a vuoto
Massima pressione di esercizio
Temperatura di stagnazione
Contenuto liquido
Massima concentrazione glicole
Liquido termovettore

FABBRICATO IN ITALIA da Riello S.p.A.

Data plate

Code	CODICE : 20075475		
Year of production	S/N : 13000000		EN 12975
Serial Number	Anno di produzione	BAR CODE 1288	Certif. 011-752399F
Description	TIPO : CP25TVS	FABBRICATO IN ITALIA da Riello S.p.A.	
Flat plate solar collector	COLLETTORE SOLARE PIANO		
	DIMENSIONI: 2003X1148X85 mm	MAX PRESSIONE ESERCIZIO: 10 bar	
	SUPERFICIE LORDA: 2,30 m ²	TEMPERATURA DI STAGNAZIONE: 197°C	
	SUPERFICIE DI APERTURA: 2,16 m ²	CONTENUTO LIQUIDO: 1,6 l	
	SUPERFICIE ASSORBITORE: 2,15 m ²	MAX CONCENTRAZIONE GLICOLE: 50%	
	PESO A VUOTO: 40 kg	LIQUIDO TERMOVETTORE: ACQUA+GLICOLE PROPILENICO	

Serial number plate

RIELLO	RIELLO S.p.A.
Via Ing. Placido Riello 7 - 37045 Legnago (VR) - Italia	
Code	Serial N°
Model	

Dimensions
Gross area
Aperture area
Absorber area
Empty weight

Maximum operating pressure
Stagnation temperature
Liquid content
Max glycol concentration
Heat transfer fluid:
water+propylene glycol

by Riello S.p.A.
Made in Italy

⚠ If these plates or any other means of clearly identifying the product are defaced, removed or lost, proper installation and servicing may be rendered difficult.

3 TECHNICAL SPECIFICATIONS

DESCRIPTION		
Total area	2,30	m ²
Exposed area	2,16	m ²
Effective absorption area	2,15	m ²
Connections (M) – (F)	1"	mm
Empty weight	40,0	kg
Liquid content	1,6	l
Recommended flow rate for each line per m ² of collector	30	l/(h x m ²)
Minimum flow rate for each line per m ² of collector	12	l/(h x m ²)
Maximum flow rate for each line per m ² of collector	60	l/(h x m ²)
Glass thickness	3,2	mm
Thickness of rock wool insulation	40	mm
Absorption (α)	95	%
Emissions (ε)	4	%
Maximum permitted pressure	10	bar
Stagnation temperature	197	°C
Maximum number of collectors in a line	6	n°

Efficiency parameters

Description	Absorber surface area	Open surface area	Gross surface area	U/M
Optical efficiency (η ₀) (*)	0,787	0,784	0,736	-
Thermal dispersion factor (a1) (*)	4,1	4,08	3,84	W/(m ² K)
Thermal dispersion temperature dependence factor (a2) (*)	0,0084	0,0084	0,0079	W/(m ² K ²)

Description		U/M
IAM (50°) (*)	0,96	-
Efficiency (η _{col}) (**)	61	%

(*) Tested according to EN 12975, referred to a 33.3% water-glycol mix, flow rate of 160 l/h, and irradiation G = 800W/m².

$$T_m = (\text{Coll.}_{\text{inlet_temp.}} + \text{Coll.}_{\text{outlet_temp.}}) / 2$$

$$T^*m = (T_m - T_{\text{ambient}}) / G$$

(**) Calculated with a temperature difference of 40K between the solar collector and the surrounding air, and with total solar radiation of 1000 W/m² referred to the exposed area.

Efficiency curve (referred to absorber surface area)

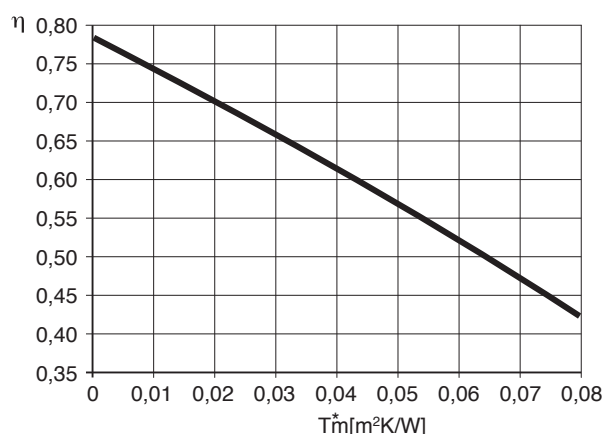

WIND AND SNOW LOADS ON COLLECTORS

Installation height above ground	Wind speed	Mass in kg to secure collector against lifting by wind		Load on roof from wind, snow, and collector weight	
		At angle of 45°	At angle of 20°	At angle of 45°	At angle of 20°
0 – 8 m	100 km/h	80 kg	40 kg	320 kg	345 kg
8 – 20 m	130 km/h	180 kg	90 kg	470 kg	430 kg
20 – 100 m	150 km/h	280 kg	150 kg	624 kg	525 kg

Maximum permitted load from wind and snow (including combined loads) on surface of collector: 1500 Pa (175 km/h).

4 CONNECTIONS

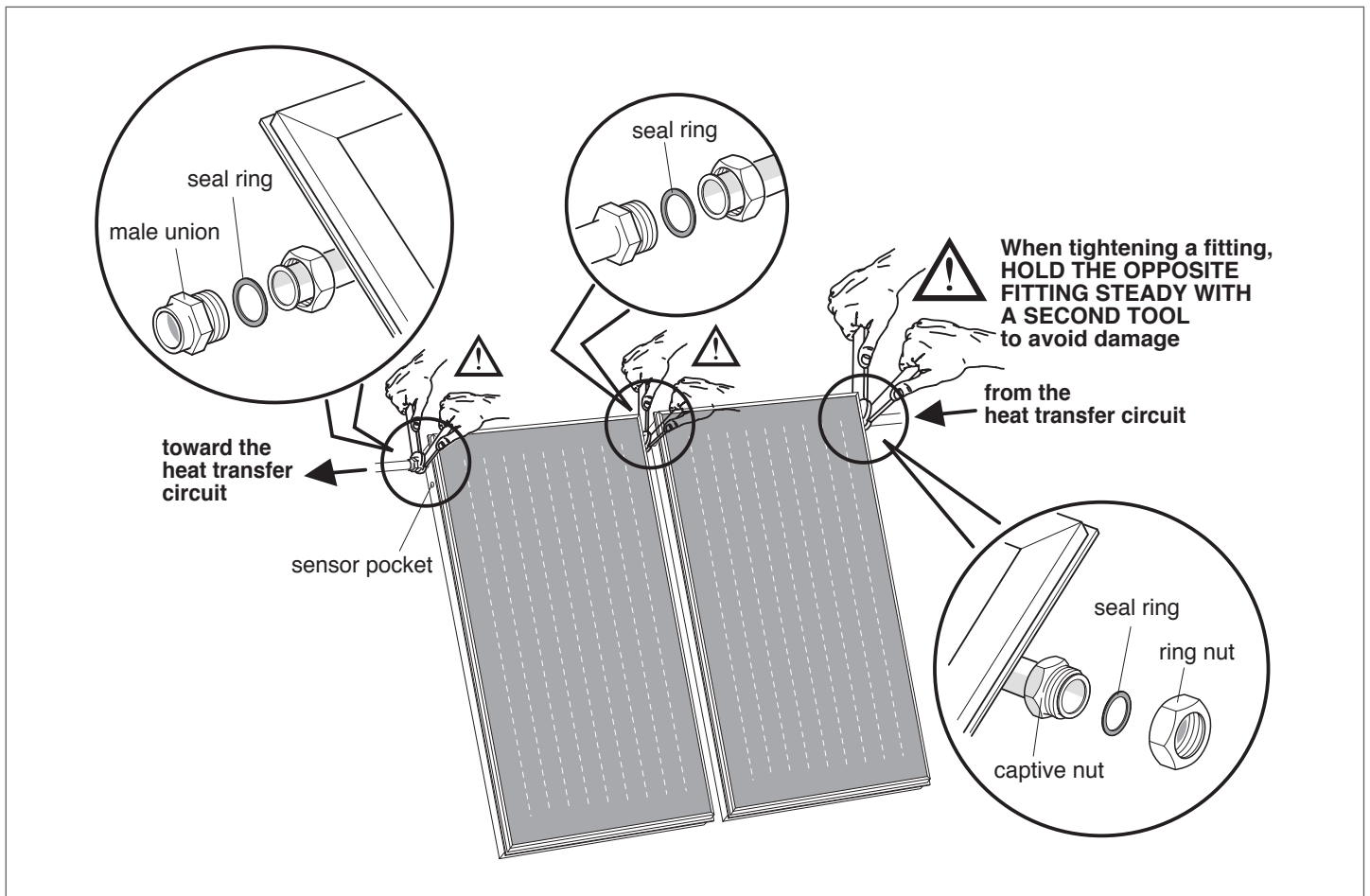

Collectors in the same line must be connected so that the heat transfer fluid flows through them in series. The pipe to the heat exchanger in the storage cylinder must be connected to the outlet with the temperature sensor socket on the last collector in the line (see figure).

Lines of solar collectors can be connected either in series (provided each line contains no more than 6 collectors) or in parallel. The complete circuit must always be hydraulically balanced. See the following sample layouts.

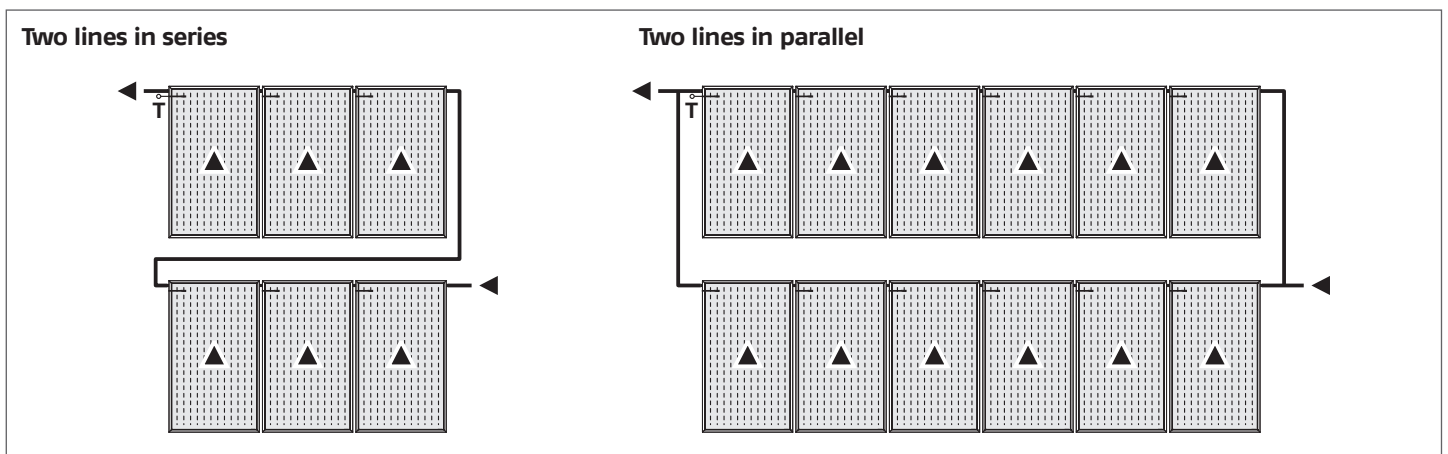

Diameter of connection pipes for a specific flow rate of 30 lt/m²h

Total surface area (m ²)	2 - 4	6 - 12	14 - 20
Diameter of copper pipe (mm)	10 - 12	14	18
Diameter of steel pipe (inch)	3/8" - 1/2"	1/2"	3/4"

5 WATER CIRCUIT

- 1 Solar collector
- 2 Storage cylinder
- 3 Collector probe
- 4 Disconnect valves
- 5 Non-return valve
- 6 Temperature gauge
- 7 Vent valve
- 8 Safety valve
- 9 Pressure gauge
- 10 Drain
- 11 Expansion vessel
- 12 Pump
- 13 Flow regulator
- 14 Flow meter
- 15 Vent cock
- 16 Manual bleed valve (accessory)
- 17 Heat transfer fluid recovery

- M Collector outlet
- R Collector return

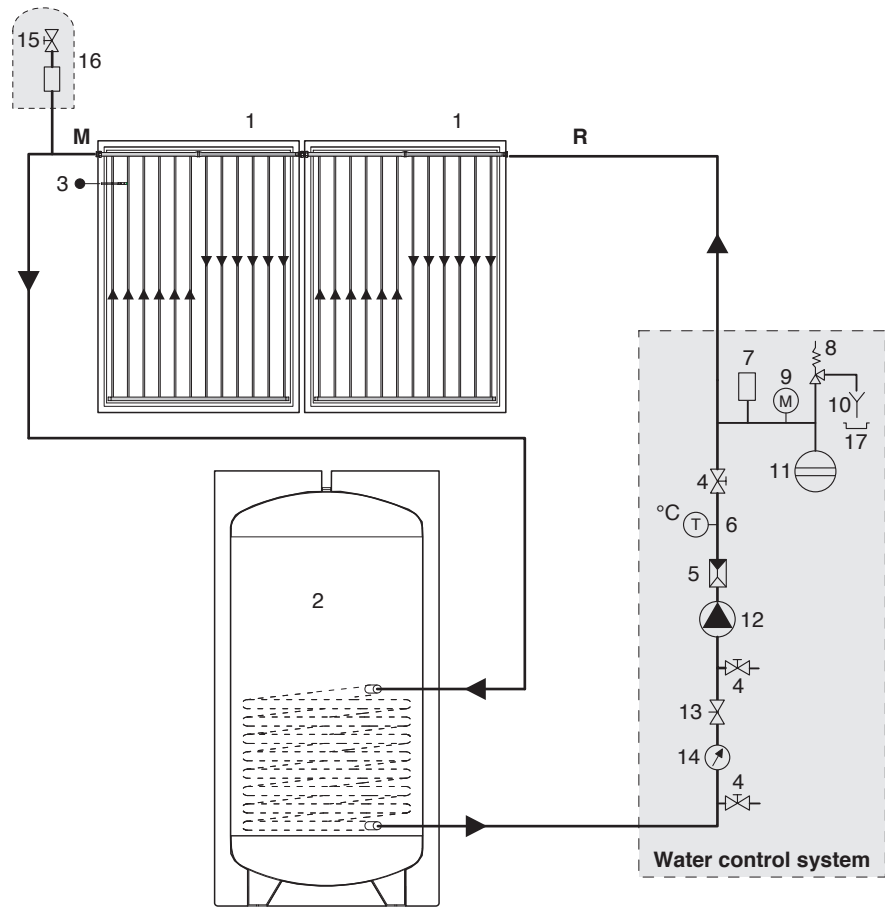

⚠ If copper pipes are used, joints must be hot brazed.

⚠ We recommend the use of stainless steel pipes specially made for solar collectors for the outlet, return and probe pipes. The probe cable should be of the shielded type.

⚠ Do not use plastic or multistrata pipes. Operating temperature can exceed 180°C.

⚠ Pipe lagging must be able to resist high temperatures (180°C).

Pressure drop in solar collectors (*)

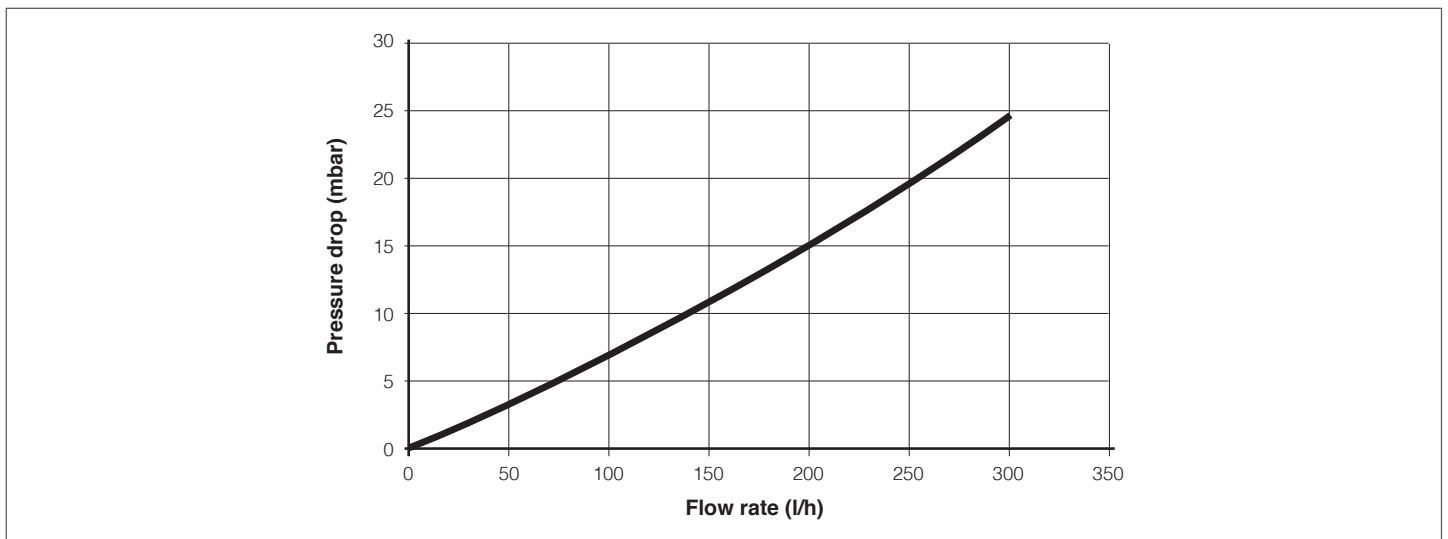

(*) With antifreeze-water mix of 33,3% / 66,7% and heat transfer medium temperature = 20°C.

6 UNPACKING THE PRODUCT

The solar collectors are packed in various ways depending on the number of units supplied:

- A Packages of 1, 2 or 3 collectors**
- B Packages of 5 collectors**
- C In a pack of 10**

Pallet contents:

- collector
- document envelopes containing instruction manual, spare parts catalogue, bar code labels and data label.

⚠ Take care not to lose the two flat seal rings (1) located in the corner profiles of each collector.

⚠ The instruction manual is an integral part of the solar connector. Once located, read it thoroughly and keep it safe.

⚠ **STORE IN A DRY PLACE AND DO NOT EXPOSE TO DIRECT SUNLIGHT UNTIL THE TIME OF INSTALLATION!** The packaging is not designed to protect the product against rain or humidity. It can also degrade if exposed to direct sunlight. Failure to comply with these precautions could lead to irreparable damage to the product.

⚠ **A protective film is applied to the glass of the solar collector. On completion of installation, only remove this film if you are going to put the system into service immediately.**

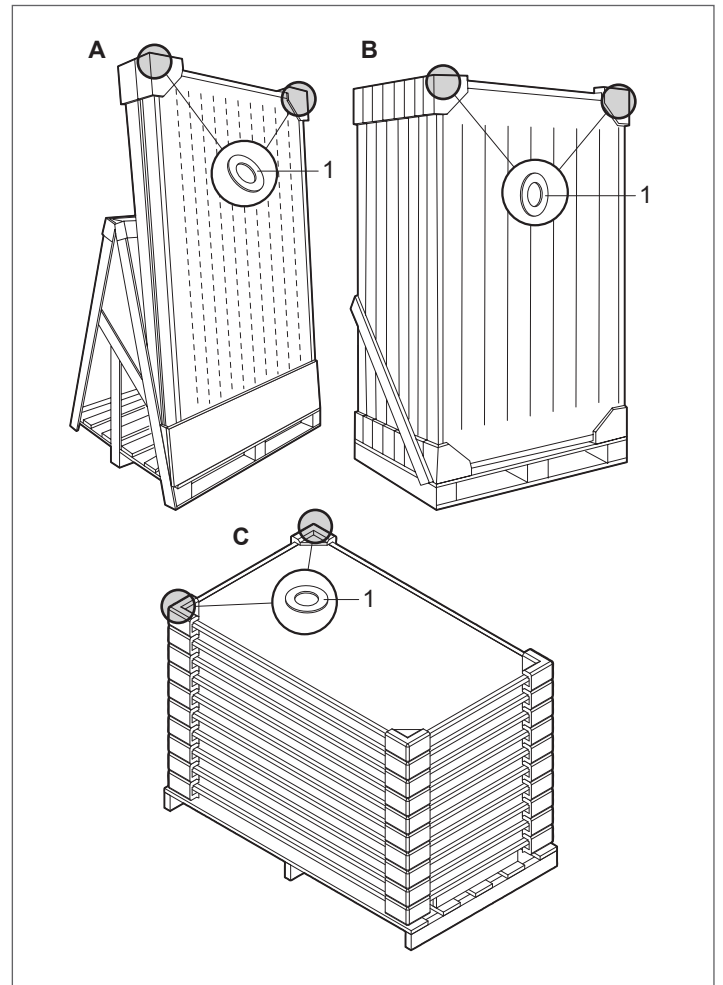

7 HANDLING

- Remove the PVC wrapping to free the solar collector from the pallet.
- Apply the data label (provided in the document envelope) to the back of the solar collector

Once you have removed the outer packaging, proceed as follows to unpack and handle the solar collector:

- Tilt the solar collector slightly and grip it at the four points shown (A) to lift it.
- Use a hoist or other suitable lifting equipment to hoist the solar collector on to the roof.

⚠ Wear suitable personal protective equipment and use suitable safety devices.

⊘ Do not dispose of packaging material into the environment, or leave it within the reach of children, since it can become a potential hazard. Dispose of packaging material in compliance with applicable legislation.

⊘ Do not lift the solar collector by its water fittings.

Data label

RIELLO RIELLO S.p.A.	
Via Ing. Paolo Riello 7 - 37045 Legnago (VI) - Italia	
Codice	
Modello	
Materiale	
COLLETTORE SOLARE (neutro)	
Codice	
Tipi	
Dimensioni	
Superficie lorda	
Superficie di apertura	
Superficie assorbibile	
Peso in vuoto	
Massima pressione di esercizio	
Temperatura di stagnazione	
Contenuto liquido	
Massima concentrazione glaciale	
Liquido termovettore	
FABBRICATO IN ITALIA da Riello S.p.A.	

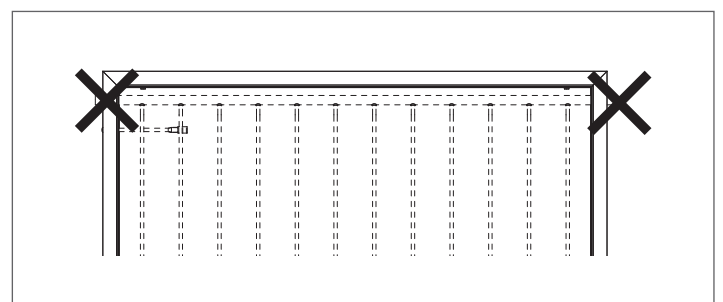
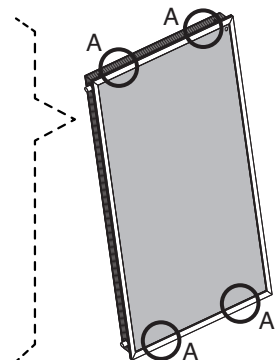

8 INSTALLATION

⚠ Solar collectors must be installed with the correct mounting kit (which includes all necessary rails and brackets) as listed in the Catalogue.

GENERAL INSTRUCTIONS

Protective film

A protective film is applied to the glass of the solar collector to protect the absorber against solar irradiation and prevent the solar collector from becoming too hot if it is not going to be put into service immediately. **Fill the system, but do not remove the film until you are ready to put the system into service.** Take care when removing the film as it may be electrostatically charged. Do not leave the protective film in place for longer than 12 months. Once removed, the protective film cannot be re-used. Dispose of the protective film in compliance with legislation governing the disposal of PVC.

Assembly

The system must be installed by specialist personnel. Use only the assembly material supplied with the solar collector. The supporting framework and all masonry or brickwork fixing points must be checked by a person expert in static loading, and must be suitable for the nature of the installation site.

Static load

The solar collector must only be installed on roofs or frames that are strong enough to support its weight. The strength of the roof or frame must be verified on site by a person expert in static loading before the solar collector is installed. During this process, it is important to verify the suitability of the supporting frame to hold the screw fasteners that fix the solar collector in place. An expert in static loading must verify that the entire frame complies with relevant standards, especially in areas liable to snow and areas exposed to high winds. Conditions (gusts of wind, formation of wind vortices, etc.) at the point where the solar collector is to be installed must be carefully considered since these can increase the loads on the supporting structure.

Lightning protection

The metal piping of the solar heating circuit must be connected to the main potential compensation bar by a (yellow-green) copper wire (H07 V-U or R) of at least 16 mm². If a lightning conductor system is already installed, the solar collectors may be connected to the existing system. Alternatively, the solar collector piping may be connected to ground via a ground wire sunk into the earth. Ground wires must be sunk outside the house. The ground wire must be connected to the potential compensation bar through a wire of the same diameter.

Water connections

The solar collectors must be connected in series using the fittings and seal rings provided. If flexible hoses are not used to connect up the ends of solar collector lines, we recommend that you fit devices in the connecting pipes to permit thermal expansion (U-type expansion joints, sections of flexible hose or dedicated expansion joints). Provided adequate expansion joints are used, up to 6 solar collectors may be connected in series. Make sure that the seal rings are correctly positioned in their seats. When tightening a fitting with a pipe wrench or spanner, always hold the opposite fitting steady with a second tool to avoid damaging the absorber.

⚠ All pipes in the water circuit must be insulated in conformity to relevant standards. Lagging and insulation must be protected against damage by the weather and birds and animals.

Angle of collectors / General

Solar collectors are designed to be installed at angles of between 15° (minimum) and 75° (maximum). Make sure that the bleed and vent valves of the collectors remain open while the collectors are being installed. Take care to protect all fittings, connections, bleed and vent valves against dirt and dust etc. In installations which serve primarily to produce domestic hot water in the summer, install the collectors facing from east to west at an angle of between 20 and 60°. The ideal orientation is southwards, at an angle equal to the latitude of the location minus 10°. If the system sustains the greatest thermal load in the winter (as in systems that combine domestic hot water production with central heating), install the collectors facing south (or south-east or south-west) at an angle greater than 35°. The ideal orientation is southwards, at an angle equal to the latitude of the location plus 10°.

⚠ The collectors must be installed at a safe distance from live electrical power lines and electrical systems in accordance with the laws and regulations in force in the country of installation. In the absence of specific standards, the minimum distance that must be maintained between the installation and the nearest point to which power lines approach when blown by the wind and sagging in warm climatic conditions is: 3 m for rated voltages of 1 kV; 3.5 m for rated voltages between 1 and 30 kV; 5 m for rated voltages between 30 and 132 kV; 7 m for rated voltages >132 kV and for unknown voltages. All non-electrical installation work that has to be performed near live and unprotected electrical power lines when there is any possibility of contact with them must be carried out in conformity to the laws and regulations in force in the country of installation. **WARNING! Contact with open, live electrical wires may lead to electrocution and may even be fatal.**

⚠ Always wear safety goggles when drilling. Always wear safety shoes, cut-proof protective gloves and a safety helmet when performing installation work.

⚠ Before beginning installation work on roofs, install the necessary fall prevention and fall arrest devices and ensure that all applicable safety standards are applied. Use only tools and materials that conform to the safety standards that are applicable in the place of work.

⚠ Only wear overalls that have a safety harness (with a suitable safety or fall-arrest belt, ropes or slings, fall dampers or dissipaters). In the absence of adequate fall prevention and security devices, failure to use a proper safety harness may lead to falls from great heights with serious or even fatal consequences.

⚠ The use of ladders leaned against walls can lead to serious falls if the ladder slips, slides or falls. When using ladders, always ensure that they are stable, and that suitable ladder stops are present. If possible secure the ladder with hooks. Make sure that there are no live electrical wires near the ladder.

⚠ Ventilation holes in the collectors allow the air inside to circulate, expand and contract freely during heating and cooling cycles. Condensation can form on the inside of the glass as a result of cooling overnight or even under conditions of high humidity during the day. This phenomenon is normal and must not be considered a defect. This condensation has no impact on the collector's thermal efficiency as it dissipates when the collector warms up in the day.

9 FILLING THE CIRCUIT

Perform the following steps before starting up the system.

1 – FLUSHING AND SEAL TESTING THE SYSTEM

If copper piping has been used and joints have been hot brazed, flush out the system to remove any brazing residues. Seal test the system after you have flushed it out.

⚠ Fill the solar collector with glycol/water mix immediately after flushing it out, because flushing water may remain trapped in the circuit (with a consequent risk of freezing).

2 – PREMIXING WATER + GLYCOL

Glycol anti-freeze is supplied separately in standard volumes and must be premixed with water in a suitable container before being used to fill the system. For example, a mix of 40% glycol and 60% water provides anti-freeze protection down to a temperature of -21°C .

⚠ The propylene glycol supplied is specially formulated for solar collector applications and remains fully efficient throughout the -32 to $+180^{\circ}\text{C}$ temperature range. It is also non-toxic, biodegradable and biocompatible.

⚠ Do NOT part fill the circuit with pure glycol then add water later.

3 – FILLING

⚠ Only fill and bleed the solar circuit at ambient temperature, with the collectors shielded from the sun's rays.

- 1 Open the non-return valve (A)
- 2 Open the air vent at the highest point in the system (see figure alongside) and keep it open throughout the filling operation
- 3 Open the vent valve (7)
- 4 Pump the heat transfer fluid around the circuit with an external filling pump until all air bubbles have been eliminated. Close the manual bleed valve
- 5 Temporarily raise the pressure in the system to 4 bar
- 6 Start up the system for about 20 minutes
- 7 Bleed the circuit again from step 2 until all the air has been removed
- 8 Set the circuit pressure according to the table on the next page in order to ensure a minimum pressure of 1.5 bar at the height of the collector field
- 9 Close the non-return valve (A) and any open vent valves to prevent the heat transfer fluid from evaporating.

⚠ Make sure that you have bled all the air out of the system, using the water control system vent too.

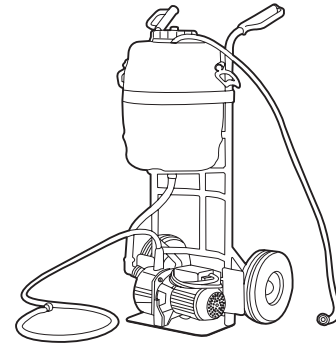

Heat transfer fluid filling pump (accessory). A manual bleed valve is not required if this pump is used.

Anti-freeze	Temperature	Density
50%	-32°C	$1,045\text{ kg/dm}^3$
40%	-21°C	$1,037\text{ kg/dm}^3$
30%	-13°C	$1,029\text{ kg/dm}^3$

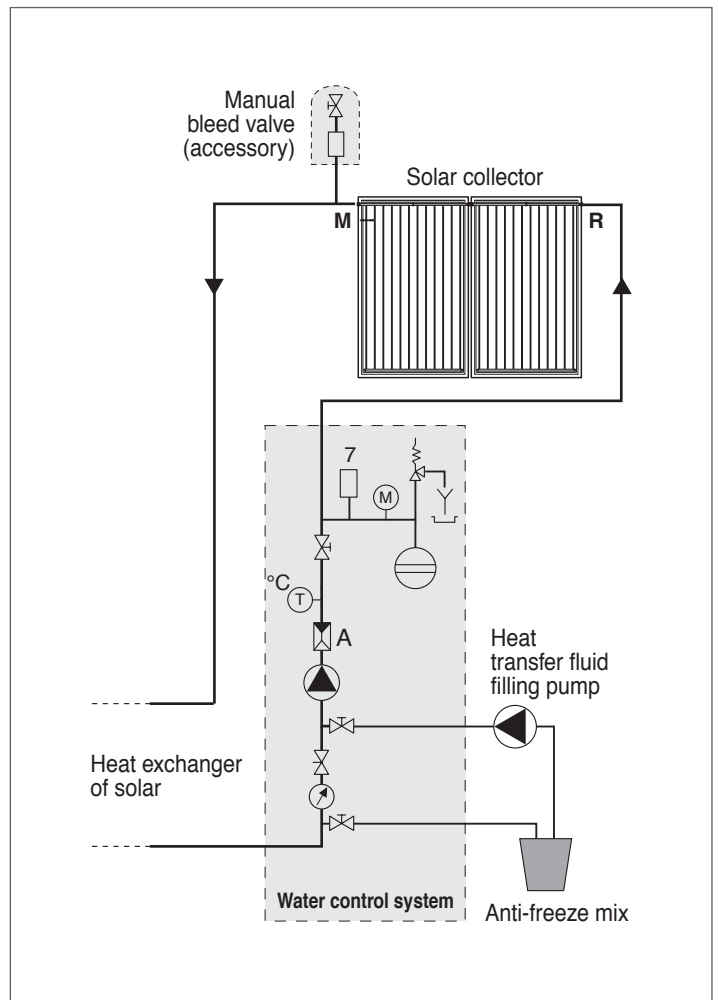

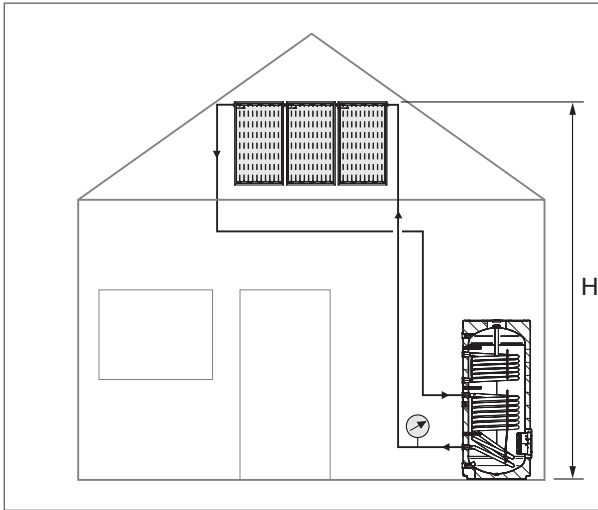

H	Pressure at boiler
up to 15 m	3 bar
15 - 20 m	3,5 bar
20 - 25 m	4 bar
25 - 30 m	4,5 bar

General rule: $p \text{ [bar]} = 1.5 + H \text{ [m]} / 10$

10 CHECKS

On completion of the installation, perform the checks listed in the table below.

Collector circuit	
Cold circuit pressure: ___ bar (see table above)	
Collector circuit seal test	
Safety valve check	
Anti-freeze checked to - ___ °C	
pH of heat transfer fluid = ___	
Collector circuit bled	
Flow rate of 30 l/h per m ² checked	
Non-return valve functioning	

Solar collectors	
Visual check of collectors	
Collectors cleaned if necessary	
Visual check of collector fixing points	
Visual check of roof impermeability	
Visual check of insulation/lagging	

11 MAINTENANCE

Service the system and perform the checks listed in the tables below at least once every two years.

Collector circuit	
Cold circuit pressure: ___ bar (see table above)	
Collector circuit seal test	
Safety valve check	
Anti-freeze checked to - ___ °C	
pH of heat transfer fluid = ___	
Collector circuit bled	
Flow rate of 30 l/h per m ² checked	
Non-return valve functioning	

Solar collectors	
Visual check of collectors	
Collectors cleaned if necessary	
Visual check of collector fixing points	
Visual check of roof impermeability	
Visual check of insulation/lagging	

Checking the heat transfer liquid

Check the anti-freeze effect and the pH level of the heat transfer liquid every 2 years.

- Use an instrument like a refractometer or densimeter to check the anti-freeze effect (which must have a nominal protection value of approx. -30°C). If the protection threshold is higher than -26°C, replace the mix, or add anti-freeze as required.
- Use litmus paper to check the pH (nominal value approx. 7.5). If the measured value is below 7, change the heat transfer liquid.



A series of horizontal dashed lines spanning the width of the page, intended for writing or drawing.

RIELLO

RIELLO S.p.A.
37045 Legnago (VR) - Italy
Tel. 0442630111 - Fax 044222378 - www.riello.it

The manufacturer strives to continuously improve all products. Appearance, dimensions, technical specifications, standard equipment and accessories are therefore liable to modification without notice.