

GB **Forced draught gas burners**

Modulating operation

CE**UK
CA****EAC**

CODE	MODEL	TYPE
20065783 - 20068261	RS 310/E BLU	1138T1
20056927 - 20068294	RS 410/E BLU	1135T1
20056930	RS 510/E BLU	1136T1
20056932	RS 610/E BLU	1137T1
20074257 - 20074254	RS 310/E BLU	1146T1
20074258 - 20074256	RS 410/E BLU	1147T1
20074259	RS 510/E BLU	1148T1
20074252	RS 610/E BLU	1149T1



Translation of the original instructions

1	Information and general warnings.....	3
1.1	Information about the instruction manual	3
1.1.1	Introduction.....	3
1.1.2	General dangers.....	3
1.1.3	Other symbols	3
1.1.4	Delivery of the system and the instruction manual	4
1.2	Guarantee and responsibility.....	4
2	Safety and prevention.....	5
2.1	Introduction.....	5
2.2	Personnel training	5
3	Technical description of the burner	6
3.1	Burner designation	6
3.2	Models available.....	7
3.3	Burner categories - Countries of destination	7
3.4	Burner equipment.....	7
3.5	Technical data.....	8
3.6	Electrical data.....	8
3.7	Maximum dimensions.....	9
3.8	Firing rates	10
3.9	Test boiler.....	11
3.10	Burner description	12
3.11	Electrical panel description.....	13
3.12	Flame control (REC 27.../REC37...).....	14
3.13	Operation sequence of the burner.....	16
3.13.1	List of phases	17
3.14	Operator panel operation	17
3.14.1	Description of the symbols on the display	17
3.14.2	Description of the buttons.....	18
3.15	Servomotor (SQM33....)	19
3.16	Calibration of the thermal relay	20
4	Installation	21
4.1	Notes on safety for the installation	21
4.2	Handling	21
4.3	Preliminary checks	21
4.4	Operating position	22
4.5	Preparing the boiler	22
4.5.1	Boring the boiler plate	22
4.5.2	Blast tube length.....	22
4.6	Securing the burner to the boiler	22
4.7	Access to head internal part.....	23
4.8	Probe-electrode position	24
4.9	Gas butterfly valve.....	24
4.10	Combustion head adjustment.....	25
4.11	Gas pressures	26
4.11.1	Gas feeding line (Example) - Please refer to the gas train documentation for more information	26
4.11.2	Gas train.....	27
4.11.3	Gas train installation.....	27
4.11.4	Gas pressure.....	28
4.12	Electrical wiring	30
4.12.1	Supply cables and external connections passage	30
5	Start-up, calibration and operation of the burner	31
5.1	Notes on safety for the first start-up	31

5.2	Adjustments prior to ignition	31
5.3	Burner start-up	31
5.4	Air / fuel adjustment	32
5.4.1	Air adjustment for maximum output	32
5.4.2	Air/fuel adjustment and output modulation system	32
5.4.3	Burner adjustment	32
5.4.4	Output upon ignition	32
5.4.5	Maximum output	32
5.4.6	Minimum output	32
5.5	Final adjustment of the pressure switches	33
5.5.1	Air pressure switch	33
5.5.2	Maximum gas pressure switch	33
5.5.3	Minimum gas pressure switch	34
5.5.4	PVP pressure switch kit	34
5.6	Visualisation and programming mode	35
5.6.1	Normal mode	35
5.6.2	Info mode	36
5.6.3	Service mode	37
5.6.4	Parameters Mode	37
5.7	Parameter modification procedure	38
5.8	Start-up procedure	40
5.9	Backup / Restore procedure	42
5.9.1	Backup	42
5.9.2	Restore	43
5.9.3	List of parameters	44
5.10	Operation	48
5.11	Motor lockout	48
5.12	Ignition failure	48
5.13	Burner flame goes out during operation	48
5.14	Stopping of the burner	49
5.15	Final checks (with burner operating)	49
6	Maintenance	50
6.1	Notes on safety for the maintenance	50
6.2	Maintenance programme	50
6.2.1	Maintenance frequency	50
6.2.2	Safety test - with gas feeding closed	50
6.2.3	Checking and cleaning	50
6.2.4	Measuring the ionisation current	51
6.2.5	Checking the air and gas pressure on the combustion head	51
6.2.6	Safety components	51
6.3	Opening the burner	52
6.4	Closing the burner	52
7	Faults - Possible causes - Solutions	53
7.1	Error codes list	53
A	Appendix - Accessories	60
B	Appendix - Electrical panel layout	61

1 Information and general warnings

1.1 Information about the instruction manual

1.1.1 Introduction

The instruction manual supplied with the burner:

- is an integral and essential part of the product and must not be separated from it; it must therefore be kept carefully for any necessary consultation and must accompany the burner even if it is transferred to another owner or user, or to another system. If the manual is lost or damaged, another copy must be requested from the Technical Assistance Service of the area;
- is designed for use by qualified personnel;
- offers important indications and instructions relating to the installation safety, start-up, use and maintenance of the burner.

Symbols used in the manual

In some parts of the manual you will see triangular DANGER signs. Pay great attention to these, as they indicate a situation of potential danger.

1.1.2 General dangers

The **dangers** can be of **3 levels**, as indicated below.



Maximum danger level!
This symbol indicates operations which, if not carried out correctly, cause serious injury, death or long-term health risks.



This symbol indicates operations which, if not carried out correctly, may cause serious injury, death or long-term health risks.



This symbol indicates operations which, if not carried out correctly, may cause damage to the machine and/or injury to people.

1.1.3 Other symbols



DANGER: LIVE COMPONENTS
This symbol indicates operations which, if not carried out correctly, lead to electric shocks with lethal consequences.



DANGER: FLAMMABLE MATERIAL
This symbol indicates the presence of flammable materials.



DANGER: BURNING
This symbol indicates the risks of burns due to high temperatures.



DANGER: CRUSHING OF LIMBS
This symbol indicates the presence of moving parts: danger of crushing of limbs.



WARNING: MOVING PARTS

This symbol indicates that you must keep limbs away from moving mechanical parts; danger of crushing.



DANGER: EXPLOSION

This symbol signals places where an explosive atmosphere may be present. An explosive atmosphere is defined as a mixture - under atmospheric conditions - of air and flammable substances in the form of gases, vapours, mist or dust in which, after ignition has occurred, combustion spreads to the entire unburned mixture.



PERSONAL PROTECTION EQUIPMENT

These symbols indicate the equipment that must be worn and kept by the operator for protection against threats against safety and/or health while at work.



OBLIGATION TO ASSEMBLE THE COVER AND ALL THE SAFETY AND PROTECTION DEVICES

This symbol signals the obligation to reassemble the cover and all the safety and protection devices of the burner after any maintenance, cleaning or checking operations.



ENVIRONMENTAL PROTECTION

This symbol gives indications for the use of the machine with respect for the environment.



IMPORTANT INFORMATION

This symbol indicates important information that you must bear in mind.



This symbol indicates a list.

Abbreviations used

Ch.	Chapter
Fig.	Figure
Page	Page
Sec.	Section
Tab.	Table

1.1.4 Delivery of the system and the instruction manual

When the system is delivered, it is important that:

- the instruction manual is delivered to the user by the system manufacturer, with the recommendation to keep it in the room where the heat generator is to be installed.
- The instruction manual shows:
 - the serial number of the burner;

.....

- the address and telephone number of the nearest Assistance Centre;

.....

- The system supplier must carefully inform the user about:
 - the use of the system;
 - any further tests that may be required before activating the system;
 - maintenance, and the need to have the system checked at least once a year by a representative of the manufacturer or another specialised technician. To ensure a periodic check, the manufacturer recommends the drawing up of a Maintenance Contract.

1.2 Guarantee and responsibility

The manufacturer guarantees its new products from the date of installation, in accordance with the regulations in force and/or the sales contract. At the moment of the first start-up, check that the burner is integral and complete.



WARNING

Failure to observe the information given in this manual, operating negligence, incorrect installation and carrying out of non authorised modifications will result in the annulment by the manufacturer of the guarantee that it supplies with the burner.

In particular, the rights to the guarantee and the responsibility will no longer be valid, in the event of damage to things or injury to people, if such damage/injury was due to any of the following causes:

- incorrect installation, start-up, use and maintenance of the burner;
- improper, incorrect or unreasonable use of the burner;
- intervention of unqualified personnel;
- carrying out of unauthorised modifications on the equipment;
- use of the burner with safety devices that are faulty, incorrectly applied and/or not working;
- installation of untested supplementary components on the burner;
- powering of the burner with unsuitable fuels;
- faults in the fuel supply system;
- continuation of use of the burner when a fault has occurred;
- repairs and/or overhauls incorrectly carried out;
- modification of the combustion chamber with inserts that prevent the regular development of the structurally established flame;
- insufficient and inappropriate surveillance and care of those burner components most likely to be subject to wear and tear;
- use of non-original components, including spare parts, kits, accessories and optional;
- force majeure.

The manufacturer furthermore declines any and every responsibility for the failure to observe the contents of this manual.

2 Safety and prevention

2.1 Introduction

The burners have been designed and built in compliance with current regulations and directives, applying the known technical rules of safety and envisaging all the potential danger situations. It is necessary, however, to bear in mind that the imprudent and clumsy use of the equipment may lead to situations of death risk for the user or third parties, as well as the damaging of the burner or other items. Inattention, thoughtlessness and excessive confidence often cause accidents; the same applies to tiredness and sleepiness.

It is a good idea to remember the following:

- The burner must only be used as expressly described. Any other use should be considered improper and therefore dangerous.

In particular:

it can be applied to boilers operating with water, steam, diathermic oil, and to other uses expressly foreseen by the manufacturer;

the type and pressure of the fuel, the voltage and frequency of the electrical power supply, the minimum and maximum deliveries for which the burner has been regulated, the pressurisation of the combustion chamber, the dimensions of the combustion chamber and the room temperature must all be within the values indicated in the instruction manual.

- Modification of the burner to alter its performance and destinations is not allowed.
- The burner must be used in exemplary technical safety conditions. Any disturbances that could compromise safety must be quickly eliminated.
- Opening or tampering with the burner components is not allowed, apart from the parts requiring maintenance.
- Only those parts envisaged by the manufacturer can be replaced.



The manufacturer guarantees safety and proper functioning only if all burner components are intact and positioned correctly.

2.2 Personnel training

The user is the person, body or company that has acquired the machine and intends to use it for the specific purpose. He is responsible for the machine and for the training of the people working around it.

The user:

- undertakes to entrust the machine exclusively to suitably trained and qualified personnel;
- undertakes to inform his personnel in a suitable way about the application and observance of the safety instructions. With that aim, he undertakes to ensure that everyone knows the use and safety instructions for his own duties.
- Personnel must observe all the danger and caution indications shown on the machine.
- Personnel must not carry out, on their own initiative, operations or interventions that are not within their province.
- Personnel must inform their superiors of every problem or dangerous situation that may arise.
- The assembly of parts of other makes, or any modifications, can alter the characteristics of the machine and hence compromise operating safety. The manufacturer therefore declines any and every responsibility for any damage that may be caused by the use of non-original parts.

In addition:



- must take all the measures necessary to prevent unauthorised people gaining access to the machine;
- the user must inform the manufacturer if faults or malfunctioning of the accident prevention systems are noticed, along with any presumed danger situation;
- personnel must always use the personal protective equipment envisaged by legislation and follow the indications given in this manual.

3 Technical description of the burner

3.1 Burner designation

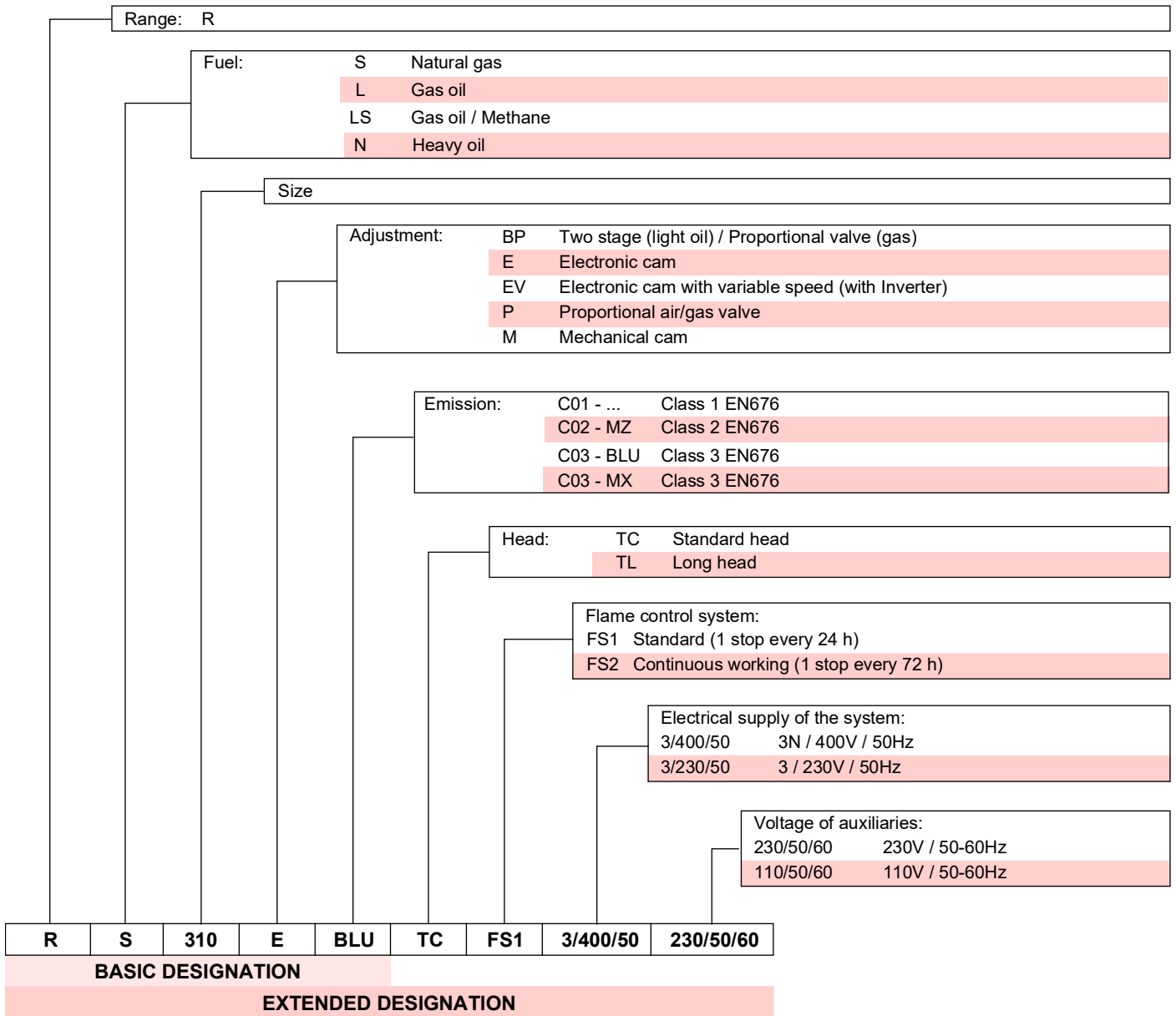

3.2 Models available

Version FS1

Designation	Voltage	Start-up	Code
RS 310/E BLU FS1	3/400/50	Stella/Triangolo	20065783
	3/400/50	Direct	20068261
RS 410/E BLU FS1	3/400/50	Star/Triangle	20056927
	3/400/50	Direct	20068294
RS 510/E BLU FS1	3/400/50	Star/Triangle	20056930
RS 610/E BLU FS1	3/400/50	Star/Triangle	20056932

Version FS2

Designation	Voltage	Start-up	Code
RS 310/E BLU FS2	3/400/50	Star/Triangle	20074257
	3/400/50	Direct	20074254
RS 410/E BLU FS2	3/400/50	Star/Triangle	20074258
	3/400/50	Direct	20074256
RS 510/E BLU FS2	3/400/50	Star/Triangle	20074259
RS 610/E BLU FS2	3/400/50	Star/Triangle	20074252

Tab. A

3.3 Burner categories - Countries of destination

Gas category	Destination country
I2H	AT - BG - CH - CZ - DK - EE - ES - FI - GB - GR - HU - IE - IS - IT - LT - LV - NO - PT - RO - SE - SI - SK - TR
I2E(R)	BE
I2E	LU - PL
I2ELL	DE
I2EK	NL
I2Er	FR

Tab. B

3.4 Burner equipment

- Gasket for gas train adaptor. No. 1
- Adaptor for gas train. No. 1
- Screws for fixing the gas train adaptor: M 16 x 70 No. 4
- Thermal insulation screen No. 1
- M 18 x 60 screws to secure the burner flange to the boiler. No. 4
- Cable grommets kit for optional electrical wiring input No. 1
- M16 nuts to fix the gas elbow to the pipe coupling. No. 8
- Stud bolts M16X60 to fix the gas elbow to the pipe coupling No. 1
- Instructions. No. 1
- Spare parts list No. 1



It is recommended to tighten the screws of the gas flange with a tightening torque of **40 Nm ±10%**.

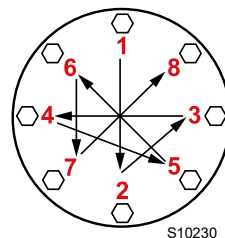

Tighten the nuts gradually (first to 30%, then to 60% up to 100%) according to the cross pattern shown in the figure.

3.5 Technical data

Model			RS 310/E BLU	RS 410/E BLU	RS 510/E BLU	RS 610/E BLU
Type	FS1		1138T1	1135T1	1136T1	1137T1
	FS2		1146T1	1147T1	1148T1	1149T1
Power ⁽¹⁾ Delivery ⁽¹⁾	min - max	kW	400/1200 ÷ 3630	500/1500 ÷ 4450	650/1800 ÷ 5250	780/2200 ÷ 6250
Fuels			Natural gas: G20 (methane gas) - G25			
Operation			FS1: Intermittent (min. 1 stop in 24 hours) FS2: Continuous			
Standard applications			Boilers: water, steam, diathermic oil			
Ambient temperature		°C	0 - 50			
Combustion air temperature		°C max	60			
Noise levels ⁽²⁾	Sound pressure	dB(A)	78	80	82.5	85
	Sound power		89	91	93.5	96
CE			CE-0476DP3335			
Weight		kg	250			280

Tab. C

(1) Reference conditions: Room temperature 20°C - Gas temperature 15°C - Barometric pressure 1013 mbar - Altitude 0 m a.s.l.

(2) Sound pressure measured in manufacturer's combustion laboratory, with burner operating on test boiler and at maximum rated output. The sound power is measured with the "Free Field" method, as per EN 15036, and according to an "Accuracy: Category 3" measuring accuracy, as set out in EN ISO 3746.

3.6 Electrical data

DIRECT START UP

Model		RS 310/E BLU	RS 410/E BLU
Code	FS1	20068261	20068294
	FS2	20074254	20074256
Main electrical supply		3 ~ 230/400V +/-10% 50 Hz	
Absorbed electrical power	kW max	9	10.8
Protection level		IP 54	

STAR - TRIANGLE START UP

Model		RS 310/E BLU	RS 410/E BLU	RS 510/E BLU	RS 610/E BLU
Code	FS1	20065783	20056927	20056930	20056932
	FS2	20074257	20074258	20074259	20074252
Main electrical supply		3N ~ 400V +/-10% 50 Hz			
Absorbed electrical power	kW max	9	10.8	13.7	17
Protection level		IP 54			

Tab. D

3.7 Maximum dimensions

The maximum dimensions of the burner are given in Fig. 1.

Bear in mind that inspection of the combustion head requires the burner to be opened and the rear part turned on the hinge.

The maximum dimensions of the open burner are indicated by the L and R positions.

The I position is reference for the refractory thickness of the boiler door.



* The gas adaptor is set also for DN 80 bore.

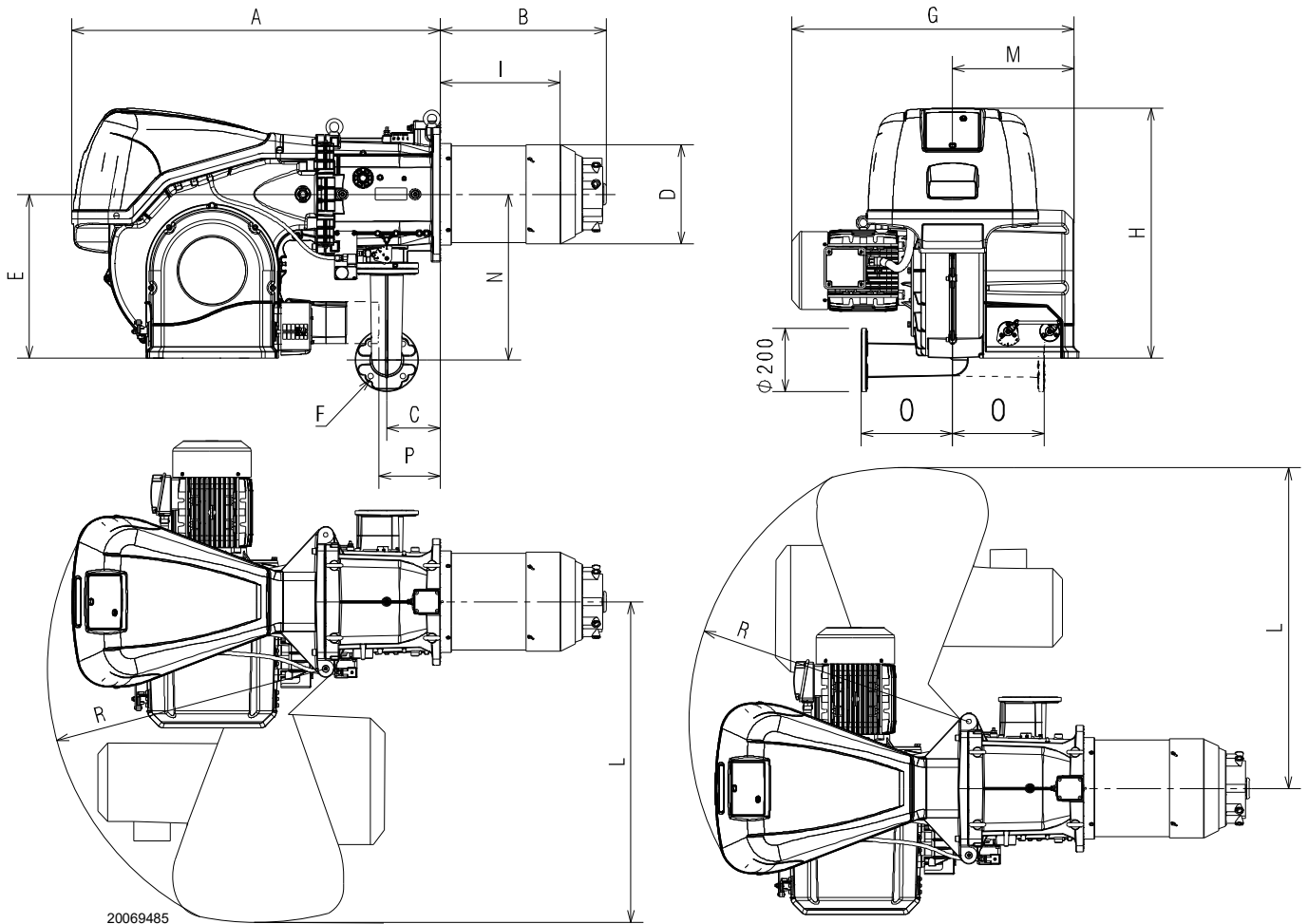

Fig. 1

mm	A	B	C	D	E	F*	G	H	I	L	M	N	O	P**	R
RS 310/E BLU	1178	465	178	306	520	DN65	890	790	346	1015	400	528	290	177	890
RS 410/E BLU	1178	517	178	313	520	DN65	930	790	340	1015	400	528	290	177	890
RS 510/E BLU	1178	517	178	313	520	DN65	930	790	340	1015	400	528	290	177	890
RS 610/E BLU	1178	517	178	334	520	DN65	980	790	365	1015	400	528	290	177	890

Tab. E

** Maximum position for the extraction of the servomotor cover.

3.8 Firing rates

The **MAXIMUM OUTPUT** is chosen from within the diagram area (Fig. 2).

The **MINIMUM OUTPUT** must not be lower than the minimum limit of the diagram:

Model	kW
RS 310/E BLU	400
RS 410/E BLU	500
RS 510/E BLU	650
RS 610/E BLU	780



The firing rate value (Fig. 2) has been obtained considering an ambient temperature of 20 °C, an atmospheric pressure of 1013 mbar (approx. 0 m a.s.l.), and with the combustion head adjusted as shown on page 25.

Tab. F

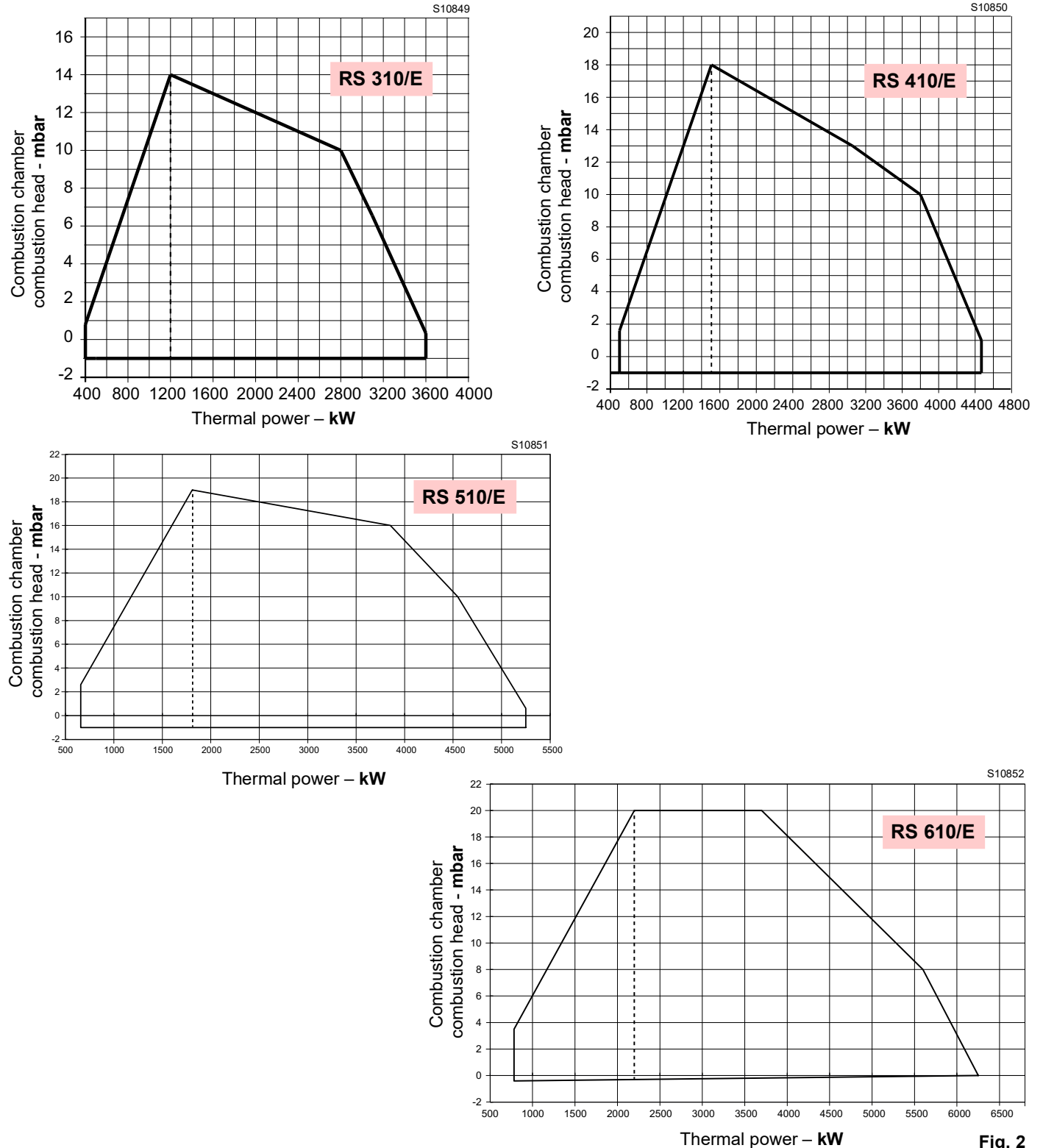

Fig. 2

3.9 Test boiler

The burner/boiler combination does not pose any problems if the boiler is EC approved and its combustion chamber dimensions are similar to those indicated in the diagram (Fig. 3).

If the burner must be combined with a boiler that has not been EC approved and/or its combustion chamber dimensions are clearly smaller than those indicated in the diagram, consult the manufacturer.

The firing rates were set in relation to special test boilers, according to EN 676 regulations.

In Fig. 3 you can see the diameter and length of the test combustion chamber.

Example: RS 510/E BLU

Output 5000 kW - diameter 100 cm - length 5 m

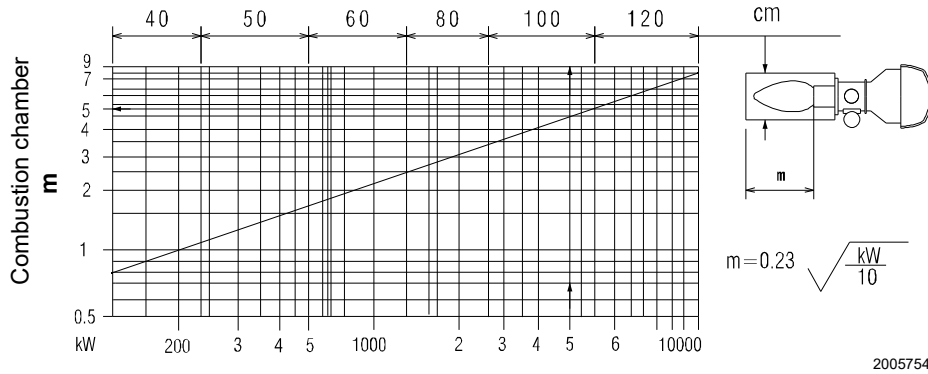

Fig. 3

3.10 Burner description

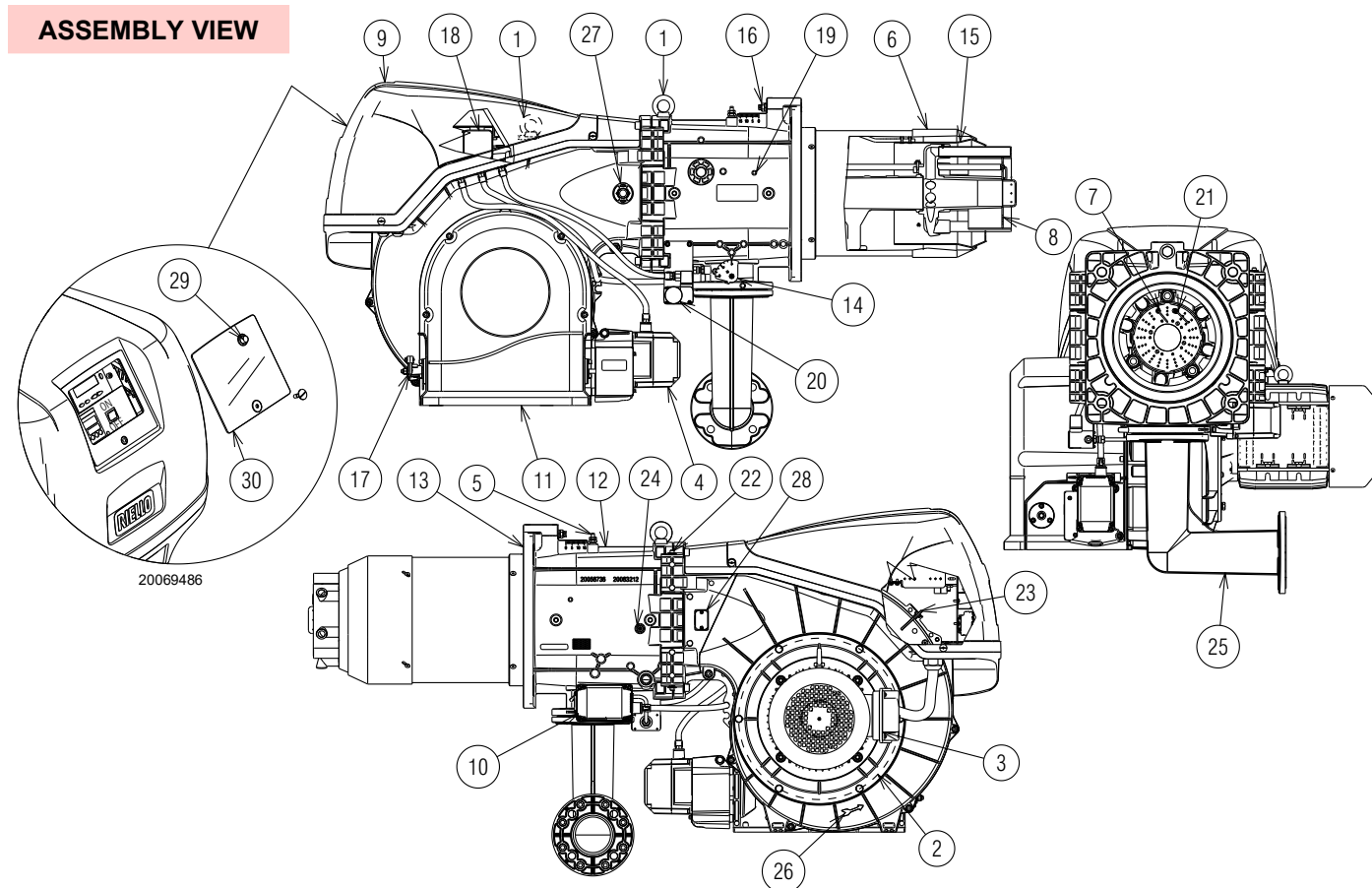

Fig. 4

- 1 Lifting rings
- 2 Fan
- 3 Fan motor
- 4 Air damper servomotor
- 5 Combustion head gas pressure test point
- 6 Combustion head
- 7 Ignition electrode
- 8 Flame stability disk
- 9 Electrical panel casing
- 10 Gas butterfly valve servomotor
- 11 Fan air inlet
- 12 Pipe coupling
- 13 Gasket for boiler fixing
- 14 Gas butterfly valve
- 15 Shutter
- 16 Combustion head movement screw
- 17 Lever for controlling the dampers with graduated scale
- 18 Air pressure switch
- 19 Combustion head air pressure test point
- 20 Maximum gas pressure switch with pressure test point
- 21 Flame sensor probe
- 22 Hinge for opening the burner
- 23 Pressure test point for air pressure switch “+”
- 24 Combustion head air pressure test points
- 25 Gas train adapter
- 26 Indication for checking the rotation direction of the purging motor
- 27 Flame inspection window
- 28 Provision for flame sensor kit
- 29 Reset button
- 30 Transparent protection



The burner can be opened to the right or to the left without links to the fuel supply side.



To open the burner see section “Access to head internal part” on page 23.

3.11 Electrical panel description

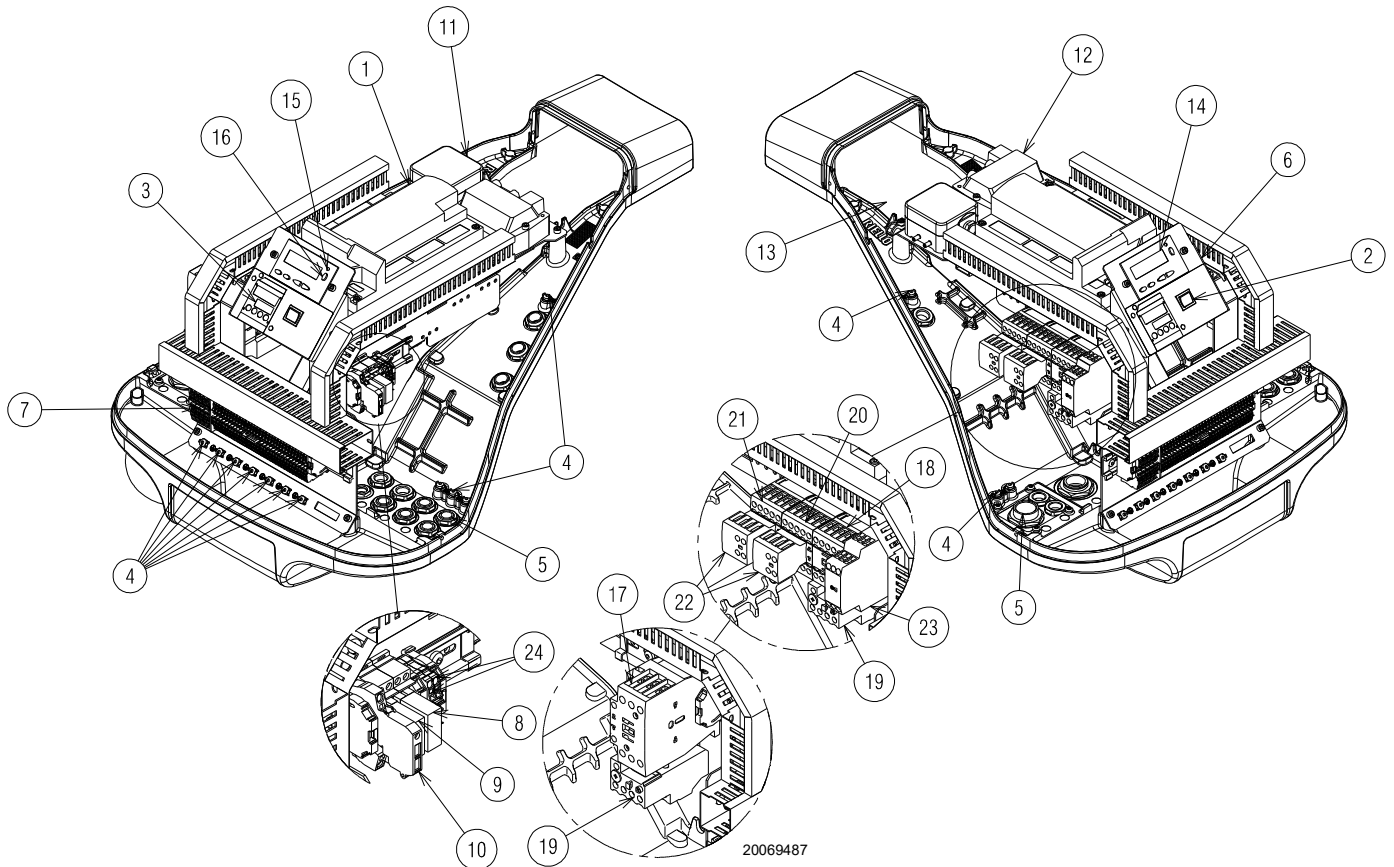

Fig. 5

- 1 Flame control
- 2 ON/OFF selector
- 3 Output regulator
- 4 Earth terminal
- 5 Supply cables and external connections passage. See section "Electrical wiring" on page 30.
- 6 Bracket for applying the kits
- 7 Main terminal supply board
- 8 Relay with clean contacts for signalling the burner is in lock-out
- 9 Relay with clean contacts for signalling the burner is operating
- 10 Auxiliary circuits fuse (includes a spare fuse)
- 11 Air pressure switch
- 12 Ignition transformer
- 13 Ionisation probe cable
- 14 Operator panel with LCD display
- 15 Light signalling burner lockout
- 16 Reset button
- 17 Direct start up line contactor
- 18 Star/triangle start-up line contactor
- 19 Thermal relay (with RESET button)
- 20 Triangle contactor (Star/triangle start up)
- 21 Star contactor (Star/triangle start up)
- 22 Auxiliary contacts
- 23 Timer for star/triangle start up
- 24 Control terminal board 4-20 mA (only FS2 models)

3.12 Flame control (REC 27.../REC37...)

Warnings



To avoid accidents, material and/or environmental damage, observe the following instructions!

The flame control is a safety device! Avoid opening or modifying it, or forcing its operation. Riello S.p.A. cannot assume any responsibility for damage resulting from unauthorised interventions!



Risk of explosion!

An incorrect configuration can provoke fuel overcharging, with the consequential risk of explosion! The operators must be aware that the incorrect setting of the visualisation and operation flame control, and of the positions of the fuel and/or air actuators, can cause dangerous conditions during burner operation.

The flame control is a system to check the burners, based on a microprocessor and equipped with components to adjust and supervise medium and large capacity forced draught burners.

The flame control contains the following components:

- burner management system with valve leak detection control device;
- electronic device to check the fuel/air ratio with a maximum of 2 actuators;
- Modbus interface.



For the safety and reliability of the flame control, comply with the following instructions:

- All interventions (assembly and installation operations, assistance, etc.) must be carried out by qualified personnel.
- Before carrying out any checks on the wiring, fully isolate the system from the electric mains (omnipolar separation). Check the system is not powered and cannot be accidentally reconnected. Failure to do this will lead to the risk of electrocution.
- Protection against electrocution from the flame control and all connected electric components is obtained with the correct assembly.
- After every intervention (assembly and installation operations, assistance, etc.), ensure the wiring is in order and that the parameters are correctly set, then perform the safety checks.
- Falls and collisions can negatively affect the safety functions. In this case, the flame control must not be operated, even if it displays no evident damage.
- During the programming of the air-fuel ratio control curves, the technician should constantly observe the quality of the combustion process (for example using a gas analyser) and, in the event of inadequate combustion values or dangerous conditions, should take appropriate action, for example shutting down the system manually.
- The plugs of the connection cables or other accessories can be disconnected when the system has been switched off.

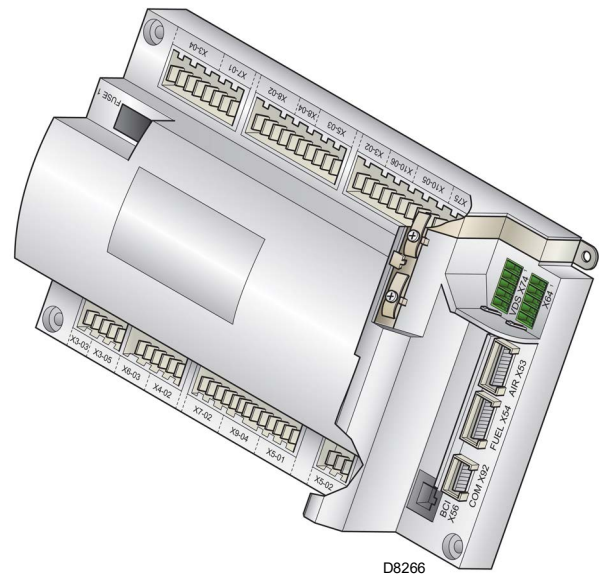

D8266

Fig. 6

- The connections to the actuators do not provide a secure separation from the mains voltage. Before connecting or changing the actuators the system should be off to avoid any conditions that could cause the formation of condensation or humidity. Otherwise, before switching on again, make sure that the entire flame control is perfectly dry!
- Static charges must be avoided since they can damage the flame control's electronic components when touched.
- Static charges must be avoided since they can damage the flame control's electronic components when touched.

Technical data

Flame control	Mains voltage	AC 230 V -15% / +10%
	Mains frequency	50 / 60 Hz ±6%
	Power absorption	< 30 W
	Safety class	I, with components in compliance with II and III, according to DIN EN 60730-1
Load on 'input' terminals	Fuse on the flame control (can be inspected)	6.3 AT
	Undervoltage	
	<ul style="list-style-type: none"> – Safety switch-off from operating position to mains voltage – Restart when mains voltage picks up 	<ul style="list-style-type: none"> < AC 186V > AC 195V
Cable length	– Main line AC 230 V	Max. 100 m (100 pF / m)
	– Control load (TL1-TL2)	Max. 20 m (100 pF/m)
	– External reset button (RS)	Max 20 m (100 pF/m)
	– Load exit (DC 0/2...10V)	Max. 10 m (100 pF/m)
	– Fuel valve	Max. 3 m (100 pF/m)
	– Other lines	Max. 3 m (100 pF/m)
Environmental conditions	Storage	DIN EN 60721-3-1
	– Climatic conditions	Class 1K3
	– Mechanical conditions	Class 1M2
	– Temperature range	-20 ... +60 °C
	– Humidity	< 95% RH
	Transport	DIN EN 60721-3-2
	– Climatic conditions	Class 2K2
	– Mechanical conditions	Class 2M2
	– Temperature range	-30 ... +60 °C
	– Humidity	< 95% RH
	Operation	DIN EN 60721-3-3
	– Climatic conditions	Class 3K3
– Mechanical conditions	Class 3M3	
– Temperature range	-20 ... +60 °C	
– Humidity	< 95% RH	

Tab. G

WARNING

Condensation, the formation of ice and the entry of water are prohibited!

3.13 Operation sequence of the burner

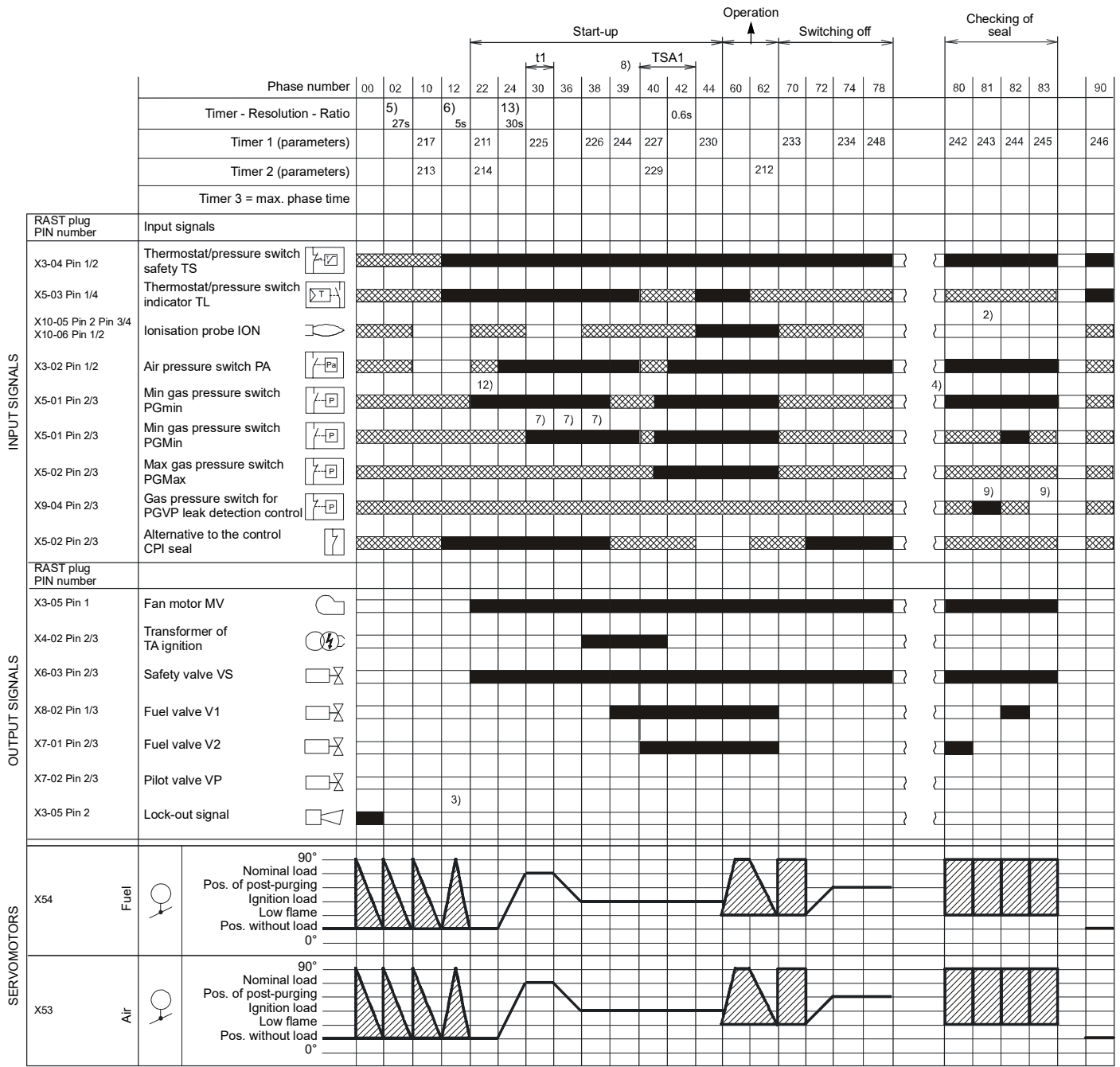





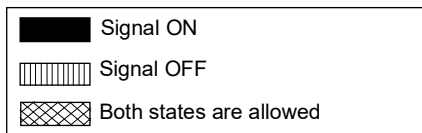











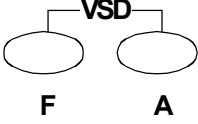

S8870

Fig. 7

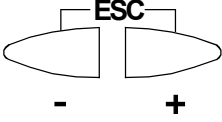

3.14.2 Description of the buttons

Button	Button	Function
	Button F	To adjust the fuel servomotor (keep  pressed and adjust the value by pressing  or )
	Button A	To adjust the air servomotor (keep  pressed and adjust the value by pressing  or )
	Buttons A and F VSD function	To change the mode setting parameter P (simultaneously press  and  plus  or )
	Button Info and Enter	<ul style="list-style-type: none"> • Enter in Parameters Mode • Reset in the event of a lockout • Access to a lower level of the menu • To navigate in Mode Info or Service and permits: <ul style="list-style-type: none"> – the selection of the parameter (flashing symbol)(press for <1 s) – access to a lower level of the menu (press from 1...3 s) – access to a higher level of the menu (press from 3...8 s) – access to another Mode (press for > 8 s)
	Button -	Lowering the value <ul style="list-style-type: none"> – Access to a lower point of the modulation curve – Scrolling the parameter list
	Button +	Increasing the value <ul style="list-style-type: none"> – Access to a higher point of the modulation curve – Scrolling the parameter list
	Buttons - and +	Quit function (ESC) (press  and  simultaneously) <ul style="list-style-type: none"> – Does not confirm the value – Access to a higher level of the menu

Tab. H

3.15 Servomotor (SQM33....)

Warnings



To avoid accidents, material or environmental damage, observe the following instructions!
Do not open, modify or force the actuators.

- All interventions (assembly and installation operations, assistance, etc.) must be carried out by qualified personnel.
- Before modifying the wiring of the servomotor in the connection area, fully disconnect the burner control device from the power supply (omnipolar separation).
- To avoid the risk of electrocution, protect the connection terminals in a suitable manner and correctly fix the cover.
- After every intervention (assembly and installation operations, assistance, etc.), ensure the wiring is in order, then make the safety checks.
- Falls and collisions can negatively affect the safety functions. In this case, the servomotor must not be operated, even if it displays no evident damage.



Assembly notes

The connection between the actuator command shaft and the control element must be rigid, without any mechanical play.

Installation notes

- The static torque is reduced when the electrical supply of the actuator is switched off.



During the maintenance or replacement of the actuators, be careful not to invert the connectors.

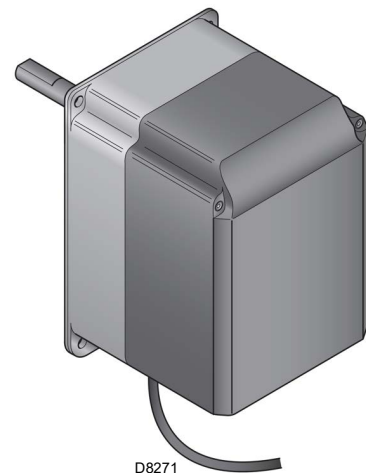

Fig. 10

Technical data

Model	SQM33.5...
Operating voltage	AC / DC 24V ± 20%
Safety class	2 according to EN 60 730
Power absorption	Max. 10 W
Protection level	IP54 in compliance with EN 60 529-1
Cable connection	RAST2,5, connectors
Rotation direction	- GAS servomotor: clockwise - Air servomotor: anticlockwise
Rated torque (max.)	3 Nm
Static torque (max.)	3 Nm
Running time for 90°	5 s.
Weight	approx. 1.4 kg
Environmental conditions:	
Operation	DIN EN 60 721-3-3
Climatic conditions	Class 3K5
Mechanical conditions	Class 3M4
Temperature range	-20...+60°C
Humidity	< 95% rh



The rotation direction is set in the factory using the flame control parameter REC ...

Tab. I



Condensation, the formation of ice and the entry of water are prohibited!

3.16 Calibration of the thermal relay

The thermal relay serves to avoid damage to the motor due to an excessive absorption increase or if a phase is missing.

For calibration 2), see the table in the wiring diagram.

To reset, in case of an intervention of the thermal relay, press the "RESET" button 1) of Fig. 11.

The red "TEST" button 3) opens the NC (95-96) contact and stops the motor.



CAUTION

The automatic reset (Position "A" button 1) can be dangerous. This operation is not anticipated in the burner's operation, leave it always on "H". **Therefore do not position the "RESET" button 1) on "A".**

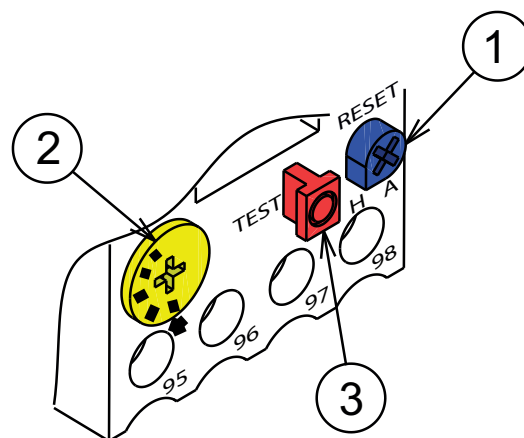

20073932

Fig. 11

4.4 Operating position



- The burner is designed to operate only in positions 1, 2, 3 and 4 (Fig. 13).
- Installation 1 is preferable, as it is the only one that allows the maintenance operations as described in this manual.
- Installations 2, 3 and 4 permit operation but make maintenance and inspection of the combustion head more difficult.



- Any other position could compromise the correct operation of the appliance.
- Installation 5 is prohibited for safety reasons.

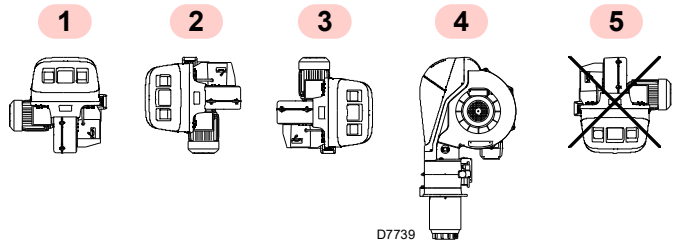

Fig. 13

4.5 Preparing the boiler

4.5.1 Boring the boiler plate

Drill the combustion chamber locking plate as shown in Fig. 14 (Tab. J). The position of the threaded holes can be marked using the thermal screen supplied with the burner.

4.5.2 Blast tube length

The length of the blast tube must be selected according to the indications provided by the manufacturer of the boiler, and in any case it must be greater than the thickness of the boiler door complete with its fettling.

For boilers with front flue passes 1)(Fig. 15) or flame inversion chamber, a protection in refractory material 5) must be inserted between the boiler fettling 2) and the blast tube 4).

The refractory can have a conical shape (minimum 60°).

This protective fettling must not compromise the extraction of the blast tube.

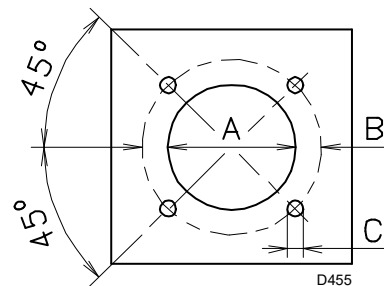

Fig. 14

mm	A	B	C
RS 310/E BLU	335	452	M18
RS 410/E BLU	335	452	M18
RS 510/E BLU	335	452	M18
RS 610/E BLU	350	452	M18

Tab. J

4.6 Securing the burner to the boiler



Prepare a suitable lifting system using the rings 3)(Fig. 15), after removing the fixing screws 7) of the casing 8).

- Fit the heat insulation supplied onto the blast tube 4)(Fig. 15).
- Fit the entire burner onto the boiler hole prepared previously (Fig. 14), and fasten with the screws supplied.



The seal between burner and boiler must be airtight.

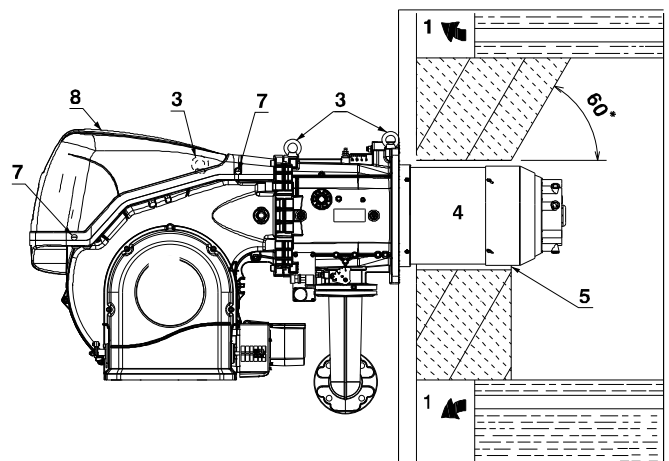

Fig. 15

4.7 Access to head internal part

The burner leaves the factory set for opening to the left, therefore maintaining the pin 1)(Fig. 16) in the housing.

To open the burner towards the left, proceed as follows:

- A disconnect the plug/socket 9)(Fig. 16) of the maximum gas pressure switch;
- B remove the screws 2);
- C open the burner to a maximum of 100-150 mm by rotating around the hinge and release the cables of the probe 5) and electrode 11);
- D fully open the burner as in Fig. 16;
- E undo the screw 4) with pressure test point;

- F release the head by lifting it from its housing 3), then take out the combustion head.



WARNING

To open the burner from the opposite side, before removing the pin 1)(Fig. 16), make sure that the 4 screws 2) are tight.

- G Then shift the pin 1) to the opposite side, only then is it possible to remove the screws 2);
- H disconnect the socket 9)(Fig. 16) of the maximum gas pressure switch, then proceed as described above at point C).

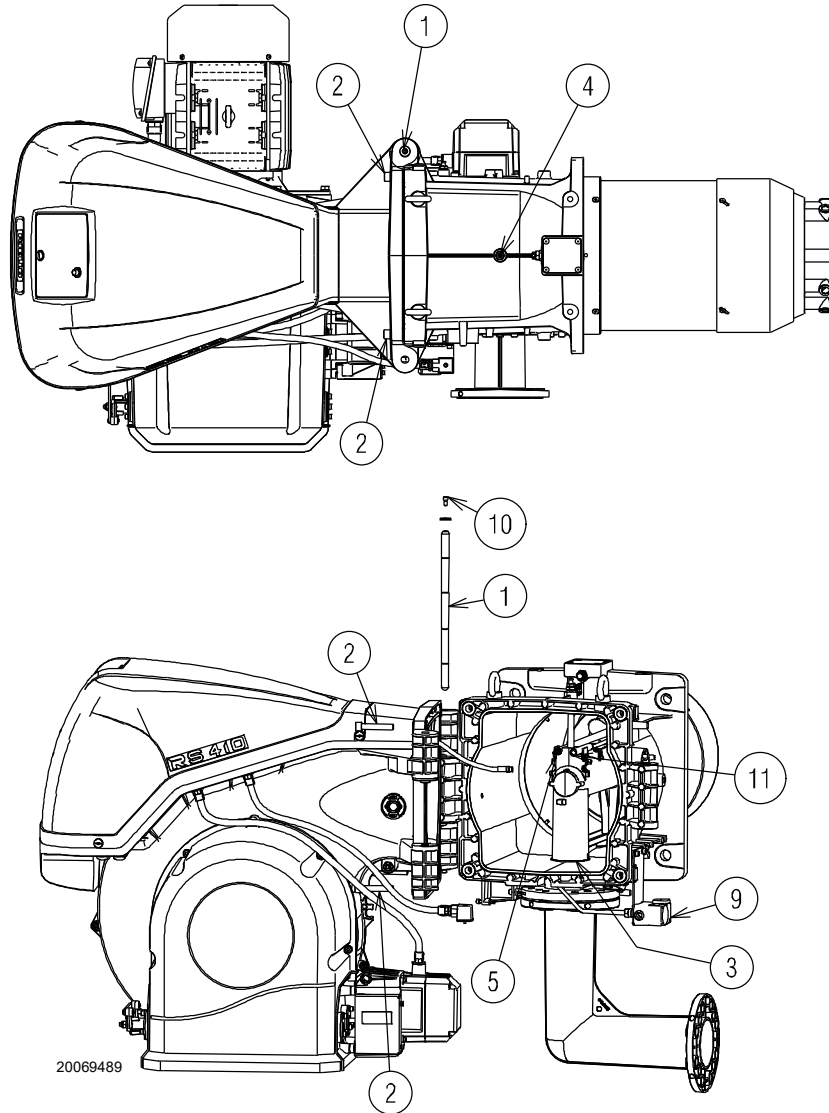

Fig. 16

4.8 Probe-electrode position



Check that the probe and the electrode are placed as in Fig. 17, according to the dimensions indicated.

RS 410-510-610/E BLU

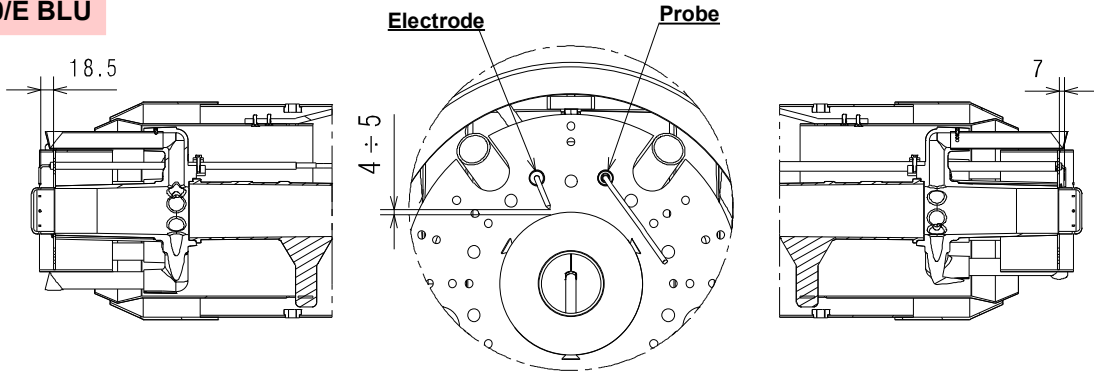

RS 310/E BLU

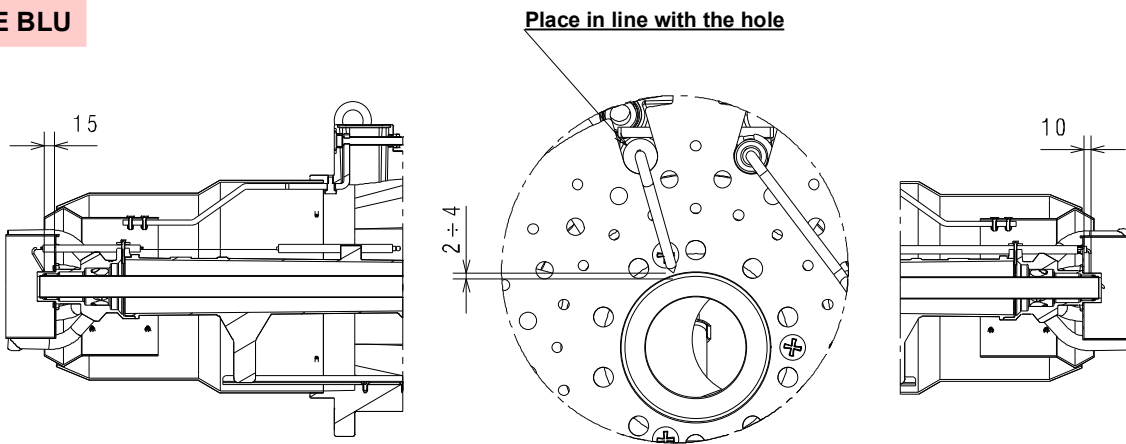

20071251

Fig. 17

4.9 Gas butterfly valve

If necessary, replace the gas butterfly valve. The correct position is indicated in Fig. 18.

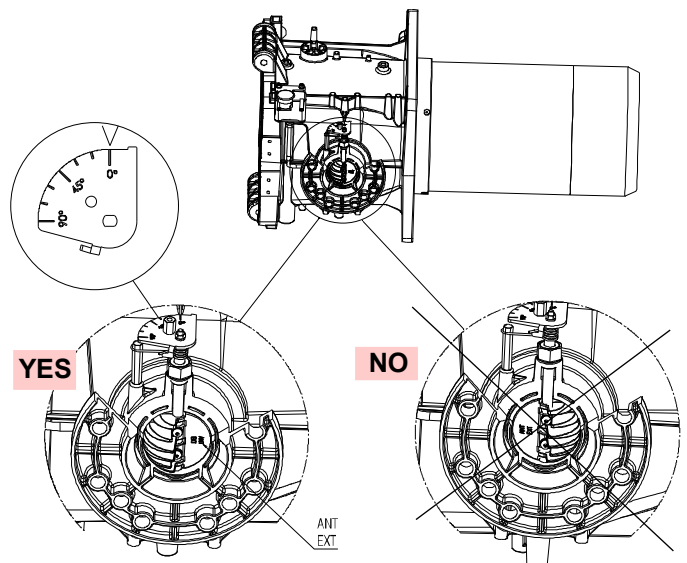

20078516

Fig. 18

4.10 Combustion head adjustment

Rotate the screw 1) until the notch you have found corresponds with the front surface of the screw itself.

The combustion head is opened by turning the screw 1) anti-clockwise.

The combustion head is closed by turning the screw 1) clockwise (Fig. 19)



The burner leaves the factory with the combustion head set at notch 0 (Fig. 19).

This setting allows to secure the movable components during the transport of the burner.

Before starting up the burner, carry out the settings according to the required output and indicated in the diagram (Fig. 20).

NOTE:

Depending on the specific application, the adjustment can be modified.

↓ No. Notches (air = gas)

20081480

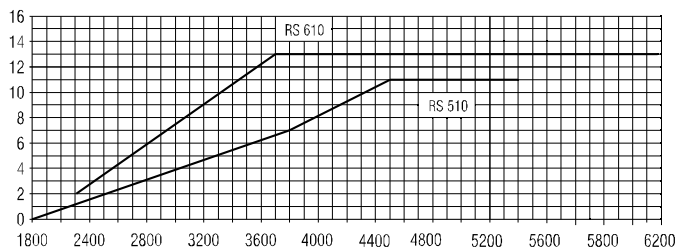
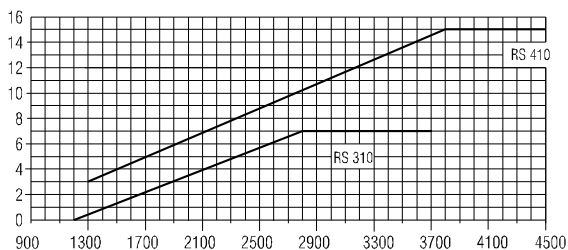

Max burner output (kW)

Fig. 19

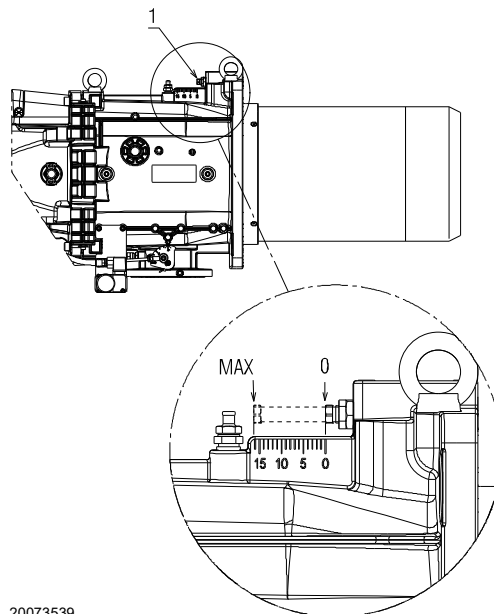

20073539

Fig. 20

Only for the RS 310 BLU model:

The RS 310 BLU burner is equipped with central air/gas adjustment. The factory setting is the following:

AIR = notch 9

GAS = notch 0.



Do not change these settings!

Only for specific cases, to change the central gas setting, do as follows:

- loosen the screws 1) and rotate the ring nut 3) until the notch you have found corresponds with the indicator 4)(Fig. 21).

To change the central air setting, do as follows:

- loosen the screws 1) and rotate the ring nut 2) until the notch you have found corresponds with the screw 1);
- Block the 2 screws 1)(Fig. 21).

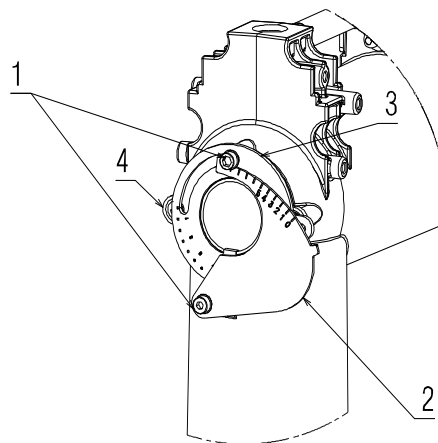

20084828

Fig. 21

4.11 Gas pressures



Explosion danger due to fuel leaks in the presence of a flammable source.

Precautions: avoid knocking, attrition, sparks and heat.

Make sure the fuel interception tap is closed before performing any operation on the burner.



WARNING

The fuel supply line must be installed by qualified personnel, in compliance with current standards and laws.

4.11.1 Gas feeding line (Example) - Please refer to the gas train documentation for more information

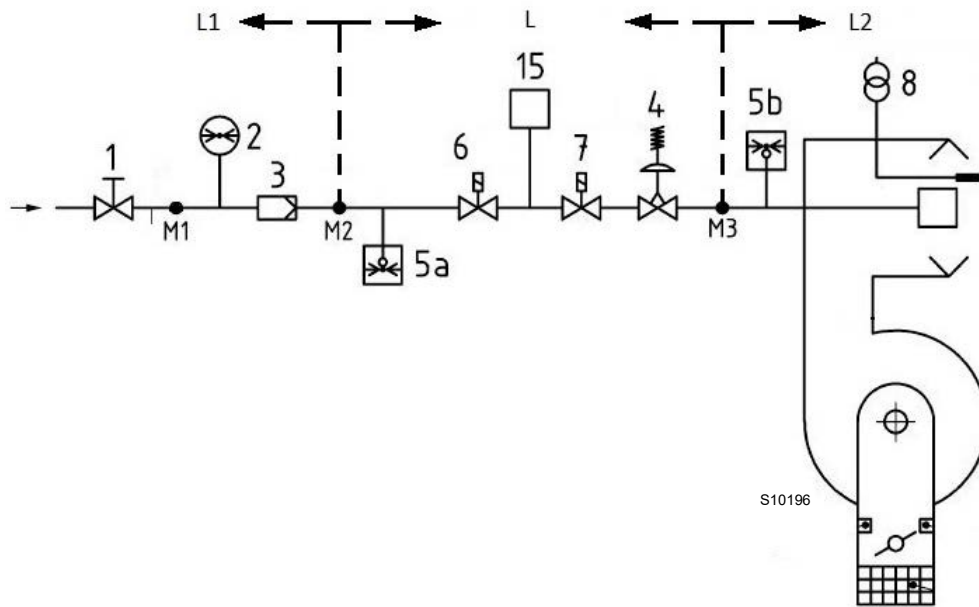

Fig. 22

Key (Fig. 22)

- 1 Manually operated shut-off valve
- 2 Pressure gauge
- 3 Filter
- 4 Governor
- 5a Low pressure protection device
- 5b Maximum gas pressure switch
- 6 1st safety shut-off device
- 7 2nd safety shut-off device
- 8 Ignition device
- 15 Valve leak detection control system
- L Gas train (supplied separately)
- L1 Responsibility of the installer
- L2 Burner
- M1 Pressure test point
- M2 Pressure test point
- M3 Pressure test point

4.11.2 Gas train

Approved according to standard EN 676 and provided separately from the burner.



Make sure that the gas train is properly installed by checking for any fuel leaks.

4.11.3 Gas train installation



DANGER

Disconnect the electrical power using the main switch.



Check that there are no gas leaks.



Pay attention when handling the train: danger of crushing of limbs.



The operator must use the required equipment during installation.

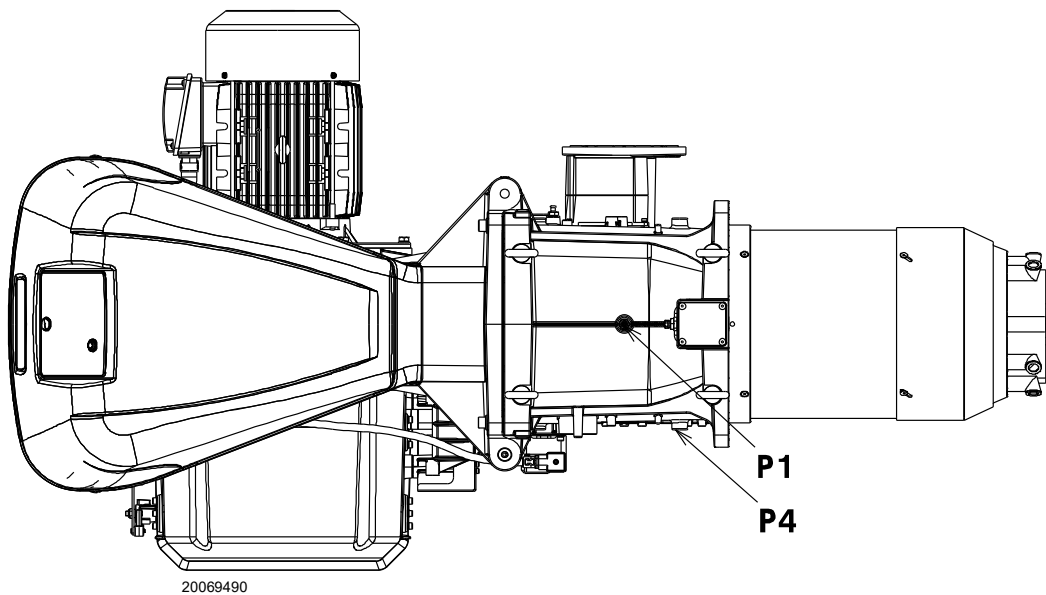

Fig. 23

4.11.4 Gas pressure

Fig. 24, Fig. 25, Fig. 26 and Fig. 27 on page 30 indicate the minimum pressure drops along the gas supply line, depending on the maximum burner output.

The values shown in Fig. 24, Fig. 25, Fig. 26 and Fig. 27 refer to:

- Natural gas G 20 NCV 9.45 kWh/Sm³ (8.2 Mcal/Sm³)
- Natural gas G 25 NCV 8.13 kWh/Sm³ (7.0 Mcal/Sm³)

Combustion head pressure drop

Gas pressure measured at the test point P1) (Fig. 23 on page 27), with:

- Combustion chamber at 0 mbar;
- Burner working at maximum output;
- Combustion head adjusted as in page 25.

To calculate the approximate maximum output of the burner in this way:

- subtract the combustion chamber pressure from the gas pressure measured at test point P1) (Fig. 23 on page 27).
- Find, in the Fig. 24, Fig. 25, Fig. 26 and Fig. 27 for the chosen burner, the pressure value closest to the result of the subtraction.
- Read the corresponding output.



The data of thermal output and combustion head gas pressure are related to full open (90°) gas butterfly valve.

Example RS 410/E BLU with G20 natural gas:

Maximum output operation
 Gas pressure at test point P1) (Fig. 23) = 58.1 mbar
 Pressure in combustion chamber = 5 mbar
 58.1 - 5 = 53.1 mbar

A pressure of 53.1 mbar, corresponds in the Fig. 24, Fig. 25, Fig. 26 and Fig. 27 to an output of 4450 kW.

This value serves as a rough guide; the effective output must be measured at the gas meter.

To calculate the required gas pressure at test point P1) (Fig. 23 on page 27), set the MAX output required from the burner operation:

- find the nearest output value in the Fig. 24, Fig. 25, Fig. 26 and Fig. 27 for the chosen burner.
- Read the pressure at the test point P1) (Fig. 23 on page 27).
- Add this value to the estimated pressure in the combustion chamber.

Example for RS 410/E BLU with G20 natural gas:

Required burner maximum output operation: 4450 kW
 Gas pressure at an output of 4450 kW = 53.1 mbar
 Pressure in combustion chamber = 5 mbar
 53.1 + 5 = 58.1 mbar
 Pressure required at test point P1) (Fig. 23 on page 27).

RS 310/E BLU

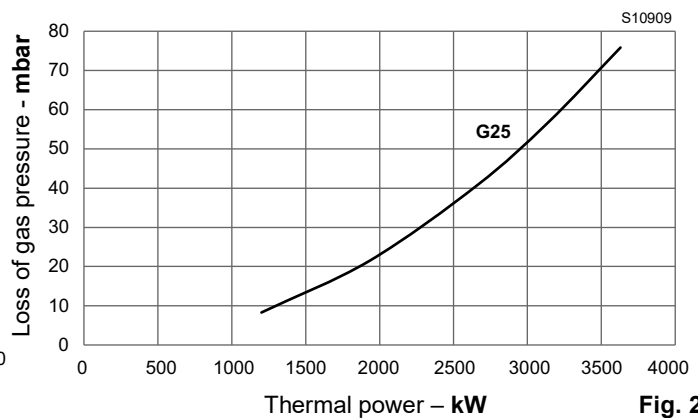
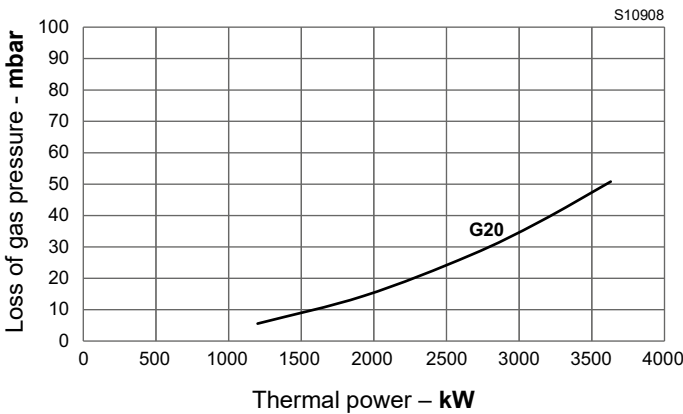

Fig. 24

RS 510/E BLU

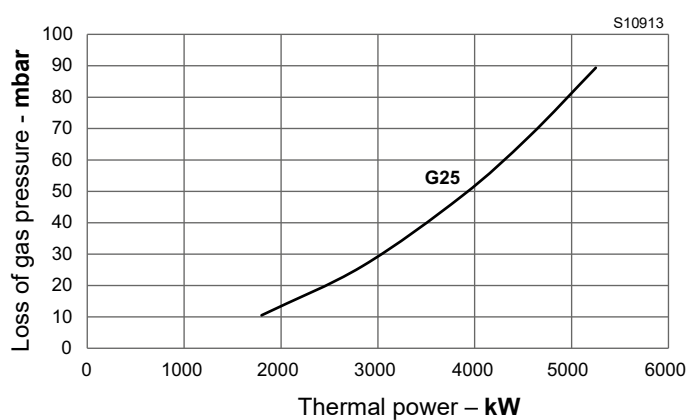
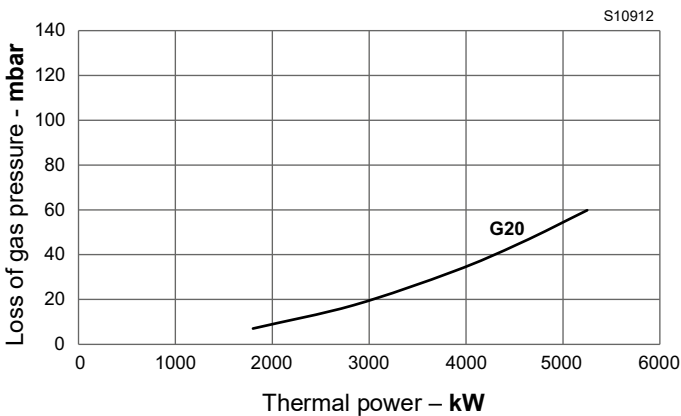

Fig. 25

RS 610/E BLU

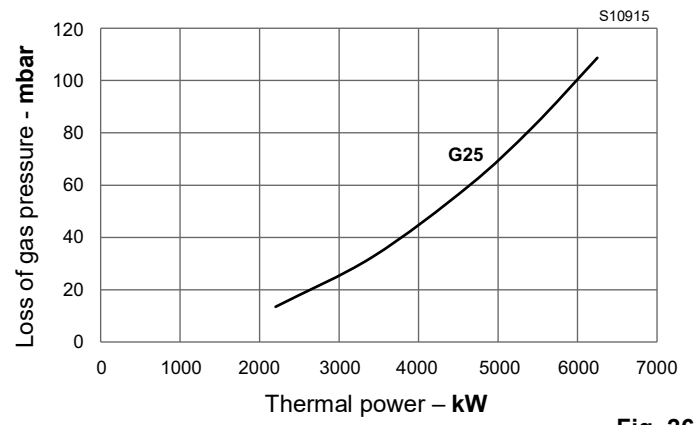
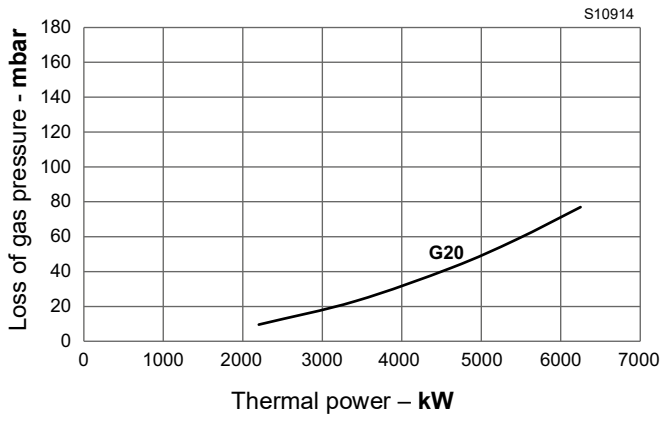

Fig. 26

4.12 Electrical wiring

Notes on safety for the electrical wiring



- The electrical wiring must be carried out with the electrical supply disconnected.
- Electrical wiring must be made in accordance with the regulations currently in force in the country of destination and by qualified personnel. Refer to the wiring diagrams.
- The manufacturer declines all responsibility for modifications or connections different from those shown in the wiring diagrams.
- Check that the electrical supply of the burner corresponds to that shown on the identification label and in this manual.
- The FS1 burners have been set for intermittent operation. This means that the burner should compulsorily be stopped at least once every 24 hours to enable the electric flame control to check its own safety and efficiency at start-up. Normally the boiler's thermostat/pressure switch ensures that the burner stops. If this is not the case, a time switch should be fitted in series to TL to stop the FS1 burner at least once every 24 hours. Refer to the wiring diagrams.
- The electrical safety of the device is obtained only when it is correctly connected to an efficient earthing system, made according to current standards. It is necessary to check this fundamental safety requirement. In the event of doubt, have the electrical system checked by qualified personnel. Do not use the gas tubes as an earthing system for electrical devices.
- The electrical system must be suitable for the maximum power absorption of the device, as indicated on the label and in the manual, checking in particular that the section of the cables is suitable for that level of power absorption.
- For the main power supply of the device from the electricity mains:
 - do not use adapters, multiple sockets or extensions;
 - use a multiple pole switch with at least a 3 mm gap between the contacts (overvoltage category III), as envisaged by the present safety standards.
- Do not touch the device with wet or damp body parts and/or in bare feet.
- Do not pull the electric cables.
- Check the electric wiring inside the boiler complies with the national and local safety regulations.
- Live and neutral should not be mixed up (this could cause dangerous malfunctions, a loss of protection against electric shocks, etc..).
- Make sure the cable grommets of the connected cables comply with the relevant standards (e.g. EN60730 and EN60 335).
- When wiring the unit, make sure that AC 230V mains voltage cables are run strictly separate from extra low-voltage cables to avoid risks of electrical shock hazard.

Before carrying out any maintenance, cleaning or checking operations:



Disconnect the electrical supply from the burner by means of the main system switch.



Turn off the fuel interception tap.



Avoid condensate, ice and water leaks from forming.

If the cover is still present, remove it and proceed with the electrical wiring according to the wiring diagrams.

Use flexible cables in compliance with the EN 60 335-1 standard.

4.12.1 Supply cables and external connections passage

All the cables to be connected to the burner must be threaded through cable grommets. The use of the cable grommets can take various forms; by way of example see Fig. 27.



After carrying out maintenance, cleaning or checking operations, reassemble the cover and all the safety and protection devices of the burner.

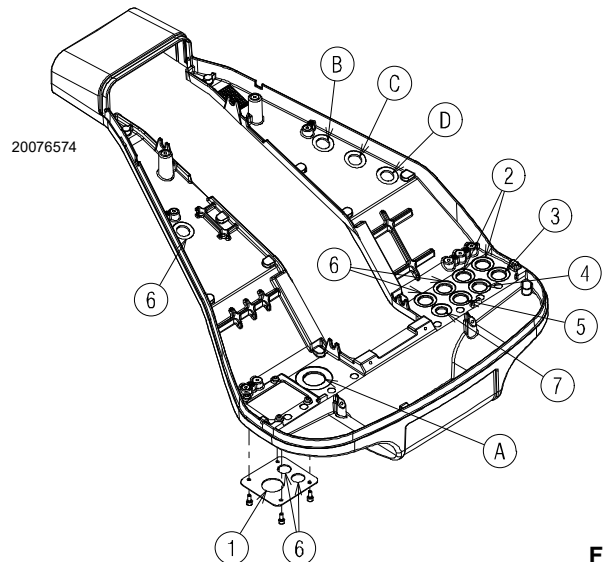

Fig. 27

Key (Fig. 27)

- 1 Electrical supply - Bore for M32
- 2 Consents and safety devices - Bore for M20
- 3 Minimum gas pressure switch - Bore for M20
- 4 VPS gas valve leak detection control kit- Bore for M20
- 5 Gas train - Bore for M20
- 6 Available - Bore for M20
- 7 Available - Bore for M16
- A Fan motor
- B Maximum gas pressure switch
- C GAS servomotor
- D AIR servomotor

5 Start-up, calibration and operation of the burner

5.1 Notes on safety for the first start-up



The first start-up of the burner must be carried out by qualified personnel, as indicated in this manual and in compliance with the standards and regulations of the laws in force.



Check the correct working of the adjustment, command and safety devices.



Before igniting the burner, see the paragraph “Safety test - with gas feeding closed” on page 50.

5.2 Adjustments prior to ignition

Combustion head adjustment has already been already described in the section “Combustion head adjustment” on page 25.

In addition, the following adjustments must also be made:

- open manual valves upstream from the gas train.
- Adjust the minimum gas pressure switch to the start of the scale.
- Adjust the maximum gas pressure switch to the end of the scale.
- Adjust the air pressure switch to the start of the scale.
- Adjust the pressure switch for the leak detection control (PVP kit)(Fig. 33 on page 34) according to the instructions supplied with the kit.
- Purge the air from the gas line. We recommend using a plastic tube routed outside the building and to purge air until gas is smelt.
- Fit a U-type pressure gauge or a differential pressure gauge (Fig. 28), with socket (+) on the gas pressure of the pipe coupling and (-) in the combustion chamber. The manometer readings are used to calculate MAX burner output using the .
- Connect two lamps or testers to the two gas line solenoids to check the exact moment in which voltage is supplied. This operation is unnecessary if each of the two solenoids is equipped with a pilot light that signals voltage passing through.



Before starting up the burner, it is good practice to adjust the gas train so that ignition takes place in conditions of maximum safety, i.e. with gas delivery at the minimum.

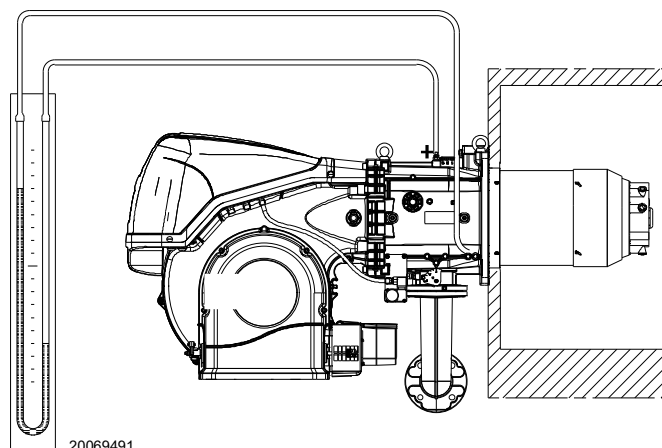

Fig. 28

5.3 Burner start-up

Electrically power the burner using the disconnecting switch on the boiler panel.

Close the thermostats/pressure switches and set the switch of Fig. 29 to “1/ON”.



Make sure that the lights or testers connected to the solenoids, or the pilot lights on the solenoids themselves, indicate that no voltage is present.

If voltage is present, stop the burner immediately and check the electrical connections.

As the burner is not fitted with a device to check the sequence of the phases, it may be that the rotation of the motor is incorrect.

As soon as the burner starts up, go in front of fan motor cooling fan and check it is rotating anticlockwise or else in the direction of the arrow shown in the diagram Fig. 4.

If this is not the case:

- put the switch of Fig. 29 to “0/OFF” and wait until the flame control carries out the switching off phase;
- disconnect the burner form the electrical supply.



Invert the phases on the three-phase power supply. This operation must be carried out with the electrical supply disconnected.

Follow the “Start-up procedure” on page 40.

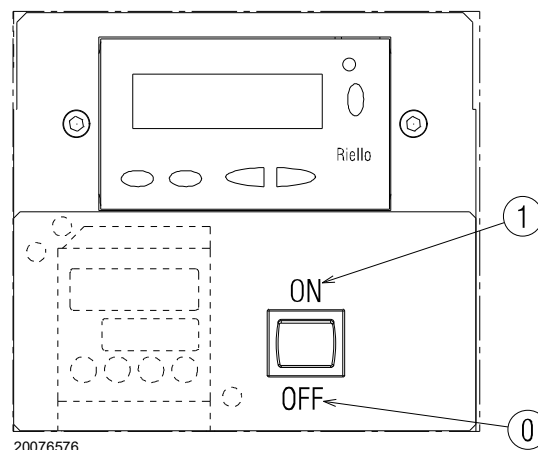

Fig. 29

5.4 Air / fuel adjustment

Air/fuel synchronisation is carried out with the relevant air and gas servomotors by logging a calibration curve by using the electronic cam.

It is advisable, to reduce the loss and for a wide calibration field, to adjust the servomotors to the maximum of the output used, the nearest possible to the maximum opening (90°).

The choking of the air, taking into account the maximum combustion output, takes place by varying the adjustment of the combustion head (see "Combustion head adjustment" on page 25).

On the gas butterfly valve, the fuel step according to the burner output required, with servomotor completely open, is carried out by the pressure stabiliser on the gas train.

5.4.1 Air adjustment for maximum output

- Adjust the servomotor to maximum opening (nearly 90°) so that the air butterfly valves are entirely open.

5.4.2 Air/fuel adjustment and output modulation system

The air/gas regulator and output modulation system equipping **RS/E** series burners performs a number of integrated functions to optimise burner function, in both individual installations and in combination with other units (e.g. double furnace boiler or multiple heat generators in parallel).

The basic system functions control:

- 1 The dosage of the air and fuel through positioning using direct servocommands of the relevant valves eliminating the possible play in the calibration systems with mechanical cam lever mechanisms, used on traditional modulating burners.
- 2 The modulation of the burner output in accordance with the load required by the system, with maintenance of the pressure or temperature of the boiler at the operating values set.
- 3 The sequence (cascade adjustment) of more than one boiler through the suitable connection of the various units and the activation of the internal software of the individual systems (option).

Further interfaces and communication functions with computers, for remote control or integration in central supervision systems are available on the basis of the configuration of the system.



WARNING

The first start up and every further internal setting operation of the adjustment system or the expansion of the base functions require access by means of password and are to be carried out by service personnel who are especially trained for the internal programming of the instrument and the specific application created with this burner.

5.4.3 Burner adjustment

The optimum adjustment of the burner requires an analysis of flue gases at the boiler outlet.

Adjust in sequence:

- 1 - Output upon ignition
- 2 - MAX output
- 3 - MIN output
- 4 - Intermediate outputs between Min. and Max.
- 5 - Air pressure switch
- 6 - Maximum gas pressure switch
- 7 - Minimum gas pressure switch

5.4.4 Output upon ignition



WARNING

For safety purposes and correct product operation, the ignition output, if it is adjustable, must be carried out by authorized personnel and in compliance with the standards and regulations of the laws in force.

Air adjustment

The adjustment of the air is carried out by changing the angle of the air damper changing the degrees of the air servomotor inside the electronic cam programme.

5.4.5 Maximum output

The MAX output must be set within the firing rate (Fig. 2 on page 10).

Adjustment of gas delivery

Measure the gas delivery on the gas meter.

As an indicative guide it can be taken from Tab. N on page 41, just read the gas pressure on the pressure gauge (shown in Fig. 37 on page 51) and follow the instructions given on page 28.

- If it is necessary to reduce it, lower the output gas pressure via the pressure adjuster located beneath the gas valve.
- If delivery needs to be increased, increase the adjuster outlet gas pressure.

Air adjustment

If necessary vary the degrees of the air servomotor.

5.4.6 Minimum output

The MIN output must be set within the firing rate (Fig. 2 on page 10).

5.5 Final adjustment of the pressure switches

5.5.1 Air pressure switch

Adjust the air pressure switch (Fig. 30) after performing all other burner adjustments with the air pressure switch set to the start of the scale.

With the burner operating at minimum output, insert a combustion analyser in the stack, slowly close the suction inlet of the fan (for example, with a piece of cardboard) until the CO value does not exceed 100 ppm.

Slowly turn the appropriate knob clockwise until the burner goes into lockout.

Check the indication of the arrow pointing upwards on the graduated scale. Turn the knob clockwise again, until the value shown on the graduated scale corresponds with the arrow pointing downwards, and so recovering the hysteresis of the pressure switch (shown by the white mark on a blue background, between the two arrows).

Now check the correct start-up of the burner. If the burner locks out again, turn the knob anti-clockwise a little bit more. During these operations it may be useful to measure the air pressure with a pressure gauge.

The connection of the pressure gauge is shown in Fig. 30. The standard configuration is that with the air pressure switch connected in absolute mode. Note the presence of a "T" connection, not supplied.

In certain applications in strong depression situations, the connection of the pressure switch does not allow it to change over. In this case it is necessary to connect the pressure switch in differential mode, applying a second tube between the air pressure switch and the fan suction line mouth.

In this case also, the pressure gauge must be connected in differential mode, as shown in Fig. 30.



Connecting the air pressure switch in differential mode, the burner will no longer be certified according to the EN 676 standard.

5.5.2 Maximum gas pressure switch

Adjust the maximum gas pressure switch (Fig. 31) after making all other burner adjustments with the maximum gas pressure switch set to the end of the scale.

To calibrate the maximum gas pressure switch, open the tap and then connect a pressure gauge to its pressure test point.

The maximum gas pressure switch must be regulated to a value no higher than 30% of the measurement read on the gauge when the burner is working at maximum output.

After making the adjustment, remove the pressure gauge and close the tap.

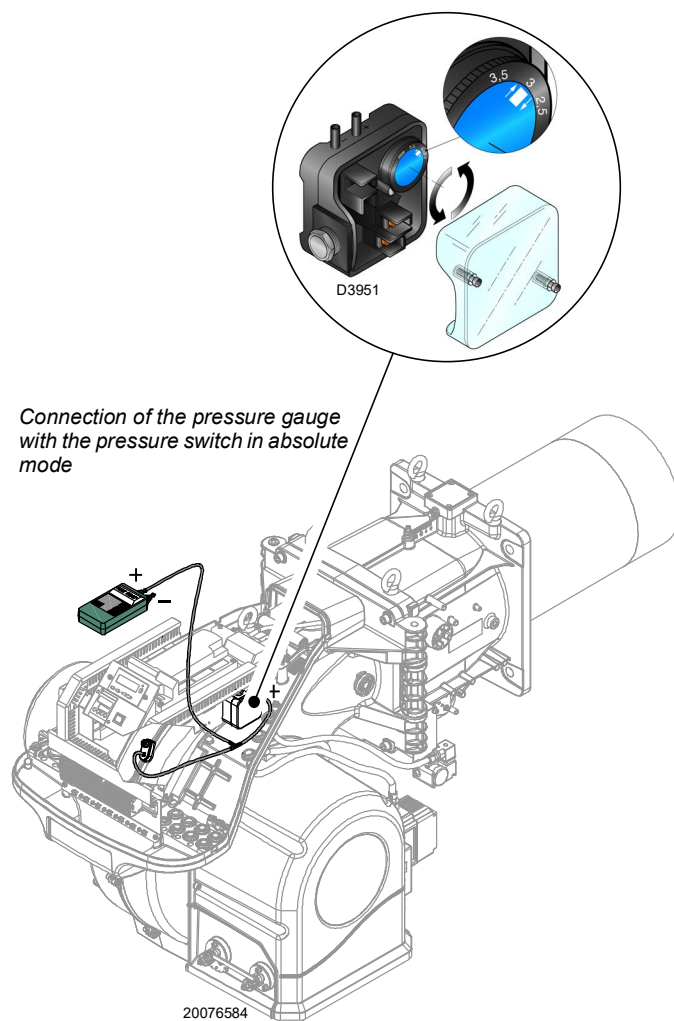

Fig. 30

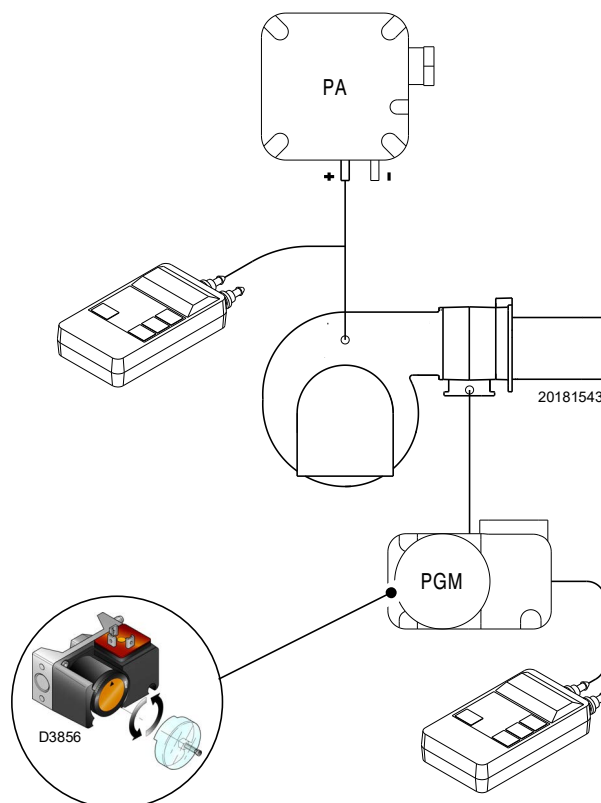

Fig. 31

5.5.3 Minimum gas pressure switch

Adjust the minimum gas pressure switch (Fig. 32) after having adjusted the burner, the gas valves and the gas train stabiliser. With the burner operating at maximum output:

- install a pressure gauge downstream of the gas train stabiliser (for example at the gas pressure test point on the burner combustion head);
- choke slowly the manual gas cock until the pressure gauge detects a decrease in the pressure read of about 0.1 kPa (1 mbar). In this phase, verify the CO value which must always be less than 100 mg/kWh (93 ppm).
- Increase the adjustment of the gas pressure switch until it intervenes, causing the burner shutdown;
- remove the pressure gauge and close the cock of the gas pressure test point used for the measurement;
- open completely the manual gas cock.



1 kPa = 10 mbar

5.5.4 PVP pressure switch kit

Adjust the pressure switch for the leak detection control (PVP kit) (Fig. 33) according to the instructions supplied with the kit.

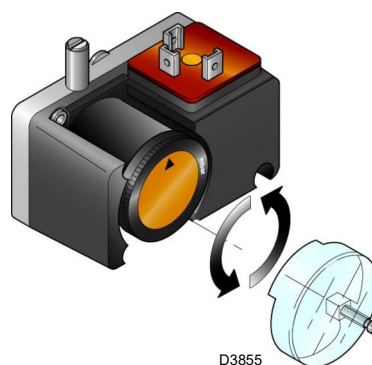

Fig. 32

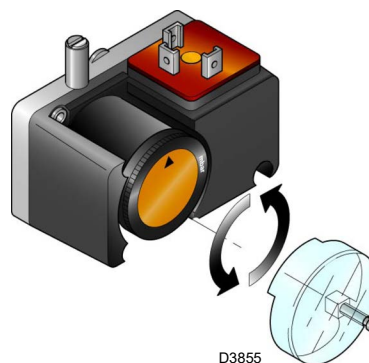

Fig. 33

5.6 Visualisation and programming mode

5.6.1 Normal mode

The Normal mode is the standard operation mode visualised on the operator panel display. It is the main level of the menu.

- Visualises the operation conditions and allows you to modify the operation point of the burner manually.
- It does not require any use of the keys of the Operator Panel.
- It allows access to the other visualisation and programming modes.

From Normal mode you can access other levels:

- Info mode (**InFo**)
- Service mode (**SEr**)
- Parameter mode (**PArA**)

Some examples in the standard conditions are given below.

5.6.1.1 Burner in stand-by display

The burner is in the heat request waiting mode, or the selector “0-1” (Fig. 29 on page 31) is at “0”.

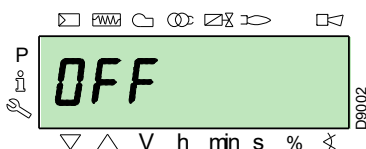

5.6.1.2 Display during starting / stopping

The display visualises the various phases of the start-up, ignition and switch-off of the burner.

In the example, the display indicates that the burner is in **Phase 30** (see diagram Fig. 34) and there are 12 seconds until the next phase.

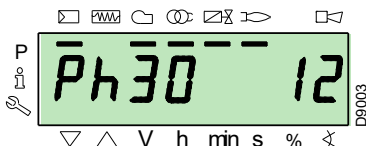

5.6.1.3 Display of the work position

The burner is working in the requested load position (in the example alongside, **78.4%**).

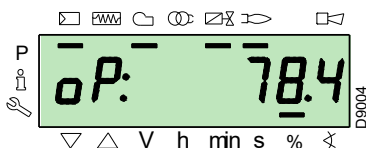

5.6.1.4 Error state message, display of the errors and information

The display visualises alternately the error code (in the example **c: 12**) and the relative diagnostic (in the example **d: 0**).

The system goes into safety mode and the message shown in the next figure appears.

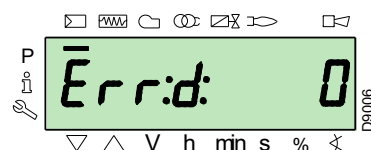
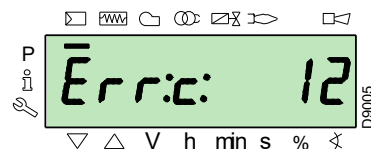

The burner goes into lockout.

The display visualises alternately the lockout code (in the example alongside **c: 4**) and the relative diagnostic (in the example **d: 3**). The red lockout lamp is on.

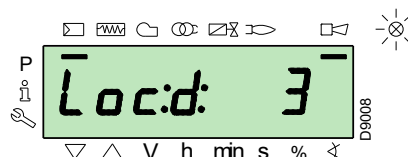
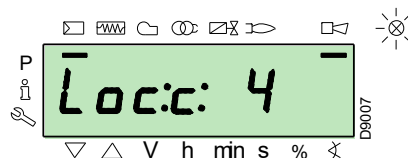

The display visualises alternately an error code and a diagnostic, which does not take the system into safety mode.

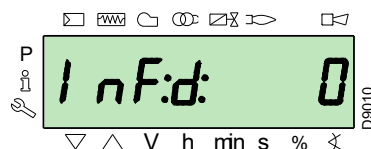
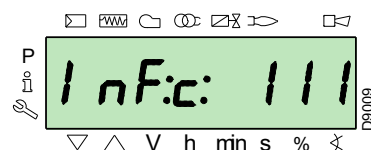

5.6.1.5 Reset procedure

The burner is in lockout when the red indicator light on the operator panel is lit up, and the display visualises the lockout code (in the example alongside **c: 4**) and the relative diagnostics (in the example **d: 3**) alternately.

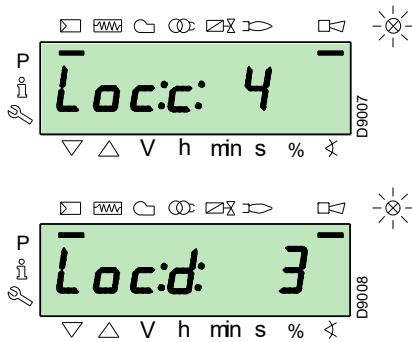

To reset, press the “i/reset” key for 1 s: the display will show “rESEt”. When the key is released, the lockout signal will disappear and the red indicator light will switch off.

The flame control is reset.

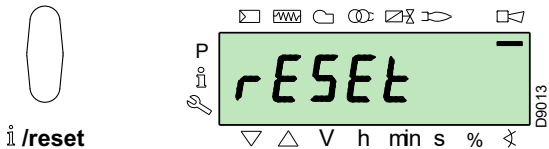

5.6.1.6 Manual lockout procedure

If necessary, it is possible to manually block the flame control and, consequently, the burner, by pressing the key “i/reset” simultaneously with any other key of the operator panel.



With the selector “0-1” (Fig. 29 on page 31), the burner does not stop immediately, but the switch-off phase is activated.

5.6.1.7 Manual operation procedure

After the adjustment of the burner and the setting of the points on the modulation curve, it is possible to manually check the operation of the burner along the entire curve.

Example:

the burner is working at the requested load percentage: 20%.

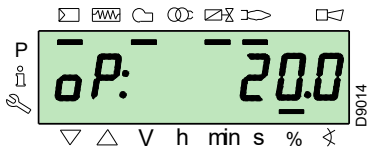

Press the “F” key for 1 second: “LoAd” is displayed and the load percentage flashes.

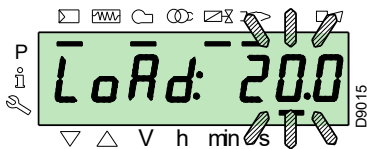

Releasing the “F” key, the standard visualisation appears, with the current load percentage flashing: this means that the burner is working in Manual mode (any outside adjustment is excluded and only the safety devices are active).

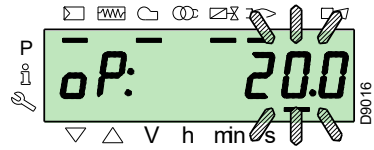

Keep the “F” key pressed and, with the keys “+” or “-”, increase or decrease the load percentage.

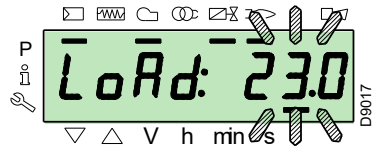

To exit manual mode, press the keys “+” and “-” (ESC) simultaneously for 3 seconds: the burner will work in Automatic mode and the output will depend on the thermostat/adjustment pressure switch (TR).

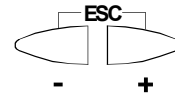

5.6.2 Info mode

The **Info mode (InFo)** visualises general system information. To access this level you must:

- press the “i/reset” key for 1-3 s.
- Release the key immediately when the display shows “InFo”.

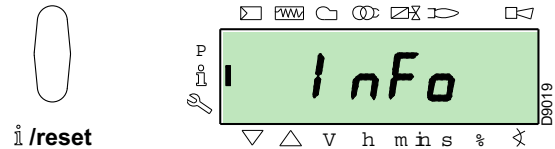

The list of parameters (in the sequence in which they are displayed) is shown in Tab. K.

No.	Parameter
167	Volumetric delivery of fuel in the unit of measurement selected
162	Operation time with flame
163	Operation time
164	No. of resettable ignitions
166	Total no. of ignitions
113	Identification code of the burner
107	Software version
108	Software variation
102	Flame control test date
103	Identification code of the flame control
104	Identification number of the group of parameters set
105	Version of the group of parameters
143	Reserved
End	

Tab. K

5.6.3 Service mode

The **Service mode (SEr)** visualises the error log and certain technical information about the system. To access this level you must:

- press the **“i/reset”** key for more than 3 s.
- Release the key immediately when the display shows **“SEr”**.

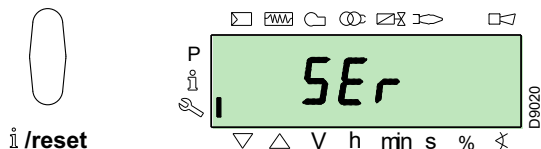

The list of parameters (in the sequence in which they are displayed) is shown in Tab. L.

No.	Parameter
954	Flame intensity (%)
960	Actual fuel which passes in units of volume / h (m ³ /h, l/h, ft ³ /h, gal/h)
121	Manual setting of output Not defined = automatic operation
922	Position of the servomotors (expressed in degrees, symbol) 0 = fuel 1 = air
161	Number of errors
701=725	Log of the errors: 701-725.01, Code

Tab. L

5.6.3.1 Operating mode on Info Mode and Service Mode

After access to these levels, the display visualises the number of the parameter (flashing) on the left, and the corresponding value on the right.

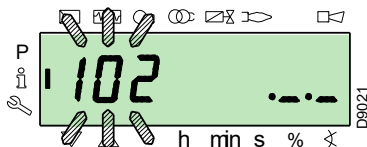

If the value is not displayed, press the **“i/reset”** key for a period of 1 to 3 seconds

To return to the Parameter List, press the **“i/reset”** key for more than 3 s, or press the keys **“+”** and **“-” (ESC)** simultaneously.

To move on to the next parameter, press the key **“+”** or **“i/reset”** for less than 1s. At the end of the list, the display visualises **“End”**.

To move back to the previous parameter, press the key **“-”**.

To return to the Normal/Standard Visualisation Mode, press the **“i/reset”** key for more than 3 s, or press the keys **“+”** and **“-” (ESC)** simultaneously.

For a moment the display will show **“OPeAte”**.

5.6.4 Parameters Mode

The **Parameters Mode (PArA)** displays and allows you to modify/programme the parameters list on page 44.

The factory-set parameters are not visible.

To access this level it is necessary to follow the **“Access procedure with password”**.

5.6.4.1 Access procedure with password

Press the **“F”** and **“A”** keys simultaneously for 1s.

For a moment the display will show **“Code”**, and immediately after you will see 7 dashes, the first one flashing.

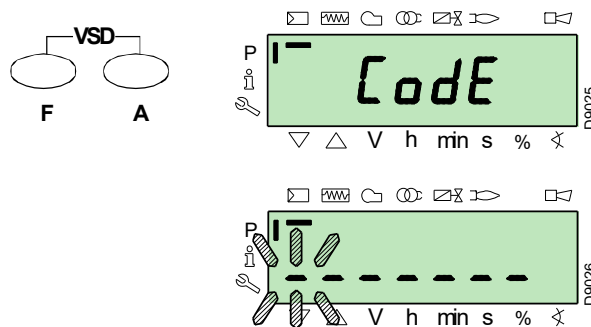

With the keys **“+”** and **“-”** select the first character of the password (letter or number), and confirm by pressing the key **“i/reset”**.

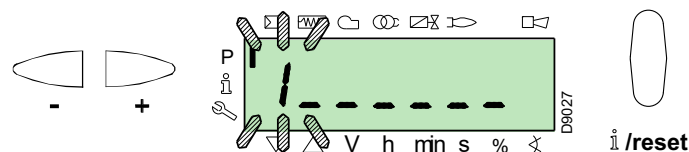

Once you have confirmed, the sign **“-”** will appear.

Continue in the same way for the other characters.

After inserting the last character of the password, confirm by pressing the key **“i/reset”**: if the password inserted is correct you will see **“PArA”** for a few seconds, then you can access the various groups of parameters.

With the keys **“+”** and **“-”** select the group you require.

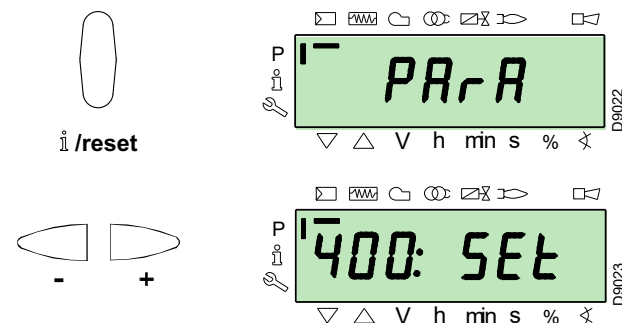

If the password inserted is incorrect, the message **“Error”** will appear for a moment. It is then necessary to repeat the procedure.

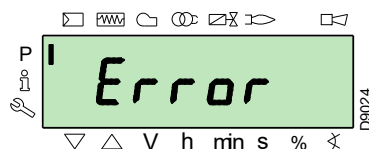



The password must only be communicated to the qualified personnel or the Technical Assistance Service, and must be kept in a safe place.

Once the access procedure has been carried out, the display will show “**PARA**” for a few seconds.

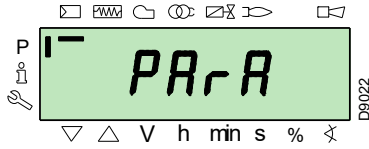

Select the group of parameters with keys “+” and “-”, and confirm by pressing the key “**i/reset**”.

Within the group you have chosen, scroll through the list with the keys “+” and “-”. At the end of the list, the display visualises “**End**”.

To return to Normal visualisation mode, simultaneously press the keys “+” and “-” (**ESC**) twice.

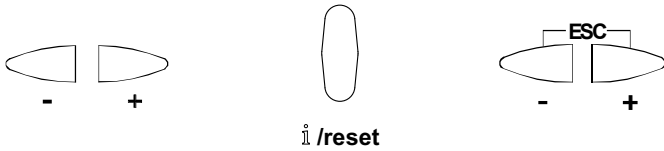

5.6.4.2 Assigning parameter levels

The parameters level is subdivided into groups as shown in Tab. M.

No.	Parameter
100: ParA	General parameters Information and identification data of the system.
200: ParA	Checks on the burner Type of operation, intervention and safety times of the various phases.
400: Set	Air/fuel modulation curve Setting of air/fuel adjustment points
500: ParA	Positioning of servomotors Choice of positions of the air/fuel servomotors in the various phases.
600: ParA	Servomotors Setting and addressing of the servomotors.
700: HISt	Log of the errors: Choice of different visualisation modes for the errors log.
900: dAtA	Process information Visualisation of information for the remote management of the burner.

Tab. M



All the parameters are checked in the factory. Modification/tampering may compromise the good operation of the burner and cause injury to people or damage to things. In any case, modifications must be carried out by qualified personnel.

To modify a parameter, refer to the “**Parameter modification procedure**”.

5.7 Parameter modification procedure

After accessing the level and group of parameters, the display visualises the number of the parameter (flashing) on the left, and the corresponding value on the right.

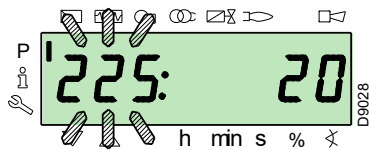

If the value is not visualised, press the key “**i/reset**” for 1 - 3 seconds.

Find below an example of how to modify the parameter relating to the **pre-purging time** (No. 225).

Press the key “**i/reset**”: the value **20** (seconds) will appear.

NOTE:

The unit of measurement of the time is not visualised but is understood in seconds.

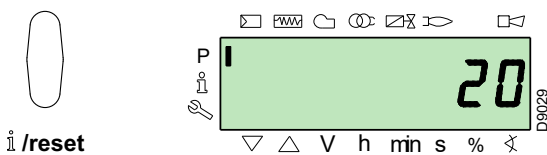

Press the key “+” and increase the value to **25** seconds (flashing). Press the key “**i/reset**” to confirm and store.

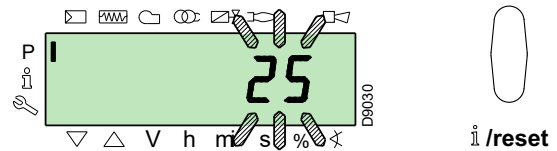

To return to the list of parameters, press the keys “+” and “-” (**ESC**) simultaneously.

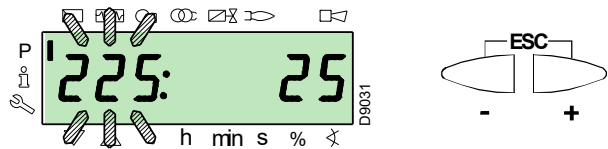

5.7.0.1 Procedure for inserting and adjusting points on the modulation curve

Nine adjustment/calibration points (P1 ÷ P9) can be inserted in the flame control for each servomotor, varying their position by degrees and, consequently, the quantity of air and fuel introduced.

The **ignition point P0** is independent of the minimum modulation value. This means that, in the event of difficulty, it is possible to switch on the burner at a value other than the modulation minimum (P1).

To access the **Parameter mode** (group 400) referring to the "Access procedure with password" on page 37.

To insert or adjust a point, proceed as follows.

Using the keys "+" and "-" insert/select the curve point you want and wait for it to flash: this means that the servomotors are now positioned on the values shown on the display and which correspond to the point previously set.

It is now possible to insert/modify the position by degrees.



The set value does not require confirmation.

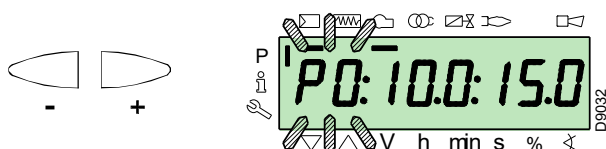

For the fuel servomotor, keep the key "F" pressed (the position in degrees flashes) and press the keys "+" or "-" to increase or decrease the value.

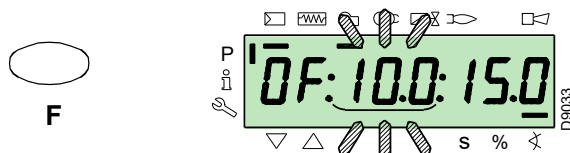

For the air servomotor, keep the key "A" pressed (the position in degrees flashes) and press the keys "+" or "-" to increase or decrease the value.



To adjust the speed of the inverter (expressed in % and that is 50 Hz = 100 %), keep the buttons "F" and "A" simultaneously pressed, the percentage position blinks and press buttons "+" or "-" to increase or decrease the value.

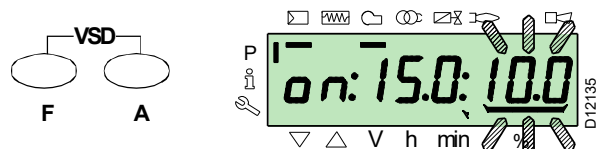

Select another point, or exit this area by pressing the keys "+" and "-" (ESC) simultaneously.

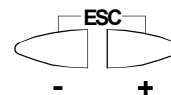

5.7.0.2 CALC function

The diagram (Fig. 34) shows how the fuel modulation curve is modified if the values of point "P5" are changed.

By keeping the "+" key pressed for more than 3 s, the points from "P6" to "P8" are recalculated.

By keeping the "-" key pressed for more than 3 s, the points from "P4" to "P2" are recalculated.

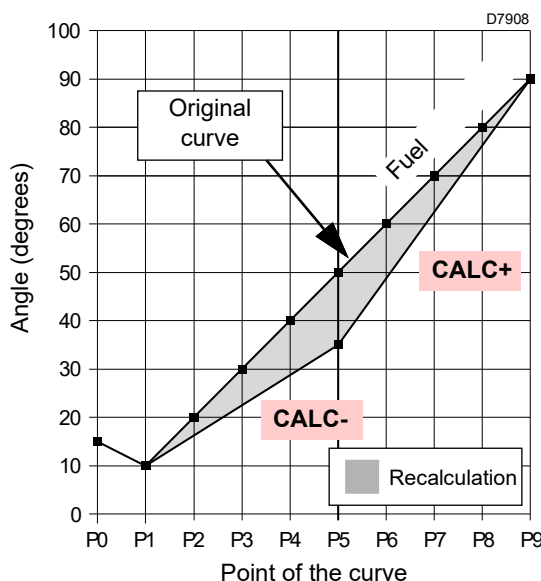

Fig. 34

The diagram of (Fig. 35) shows the fuel modulation curve when, after the modification of point "P5", the recalculation of all the other points is not carried out.

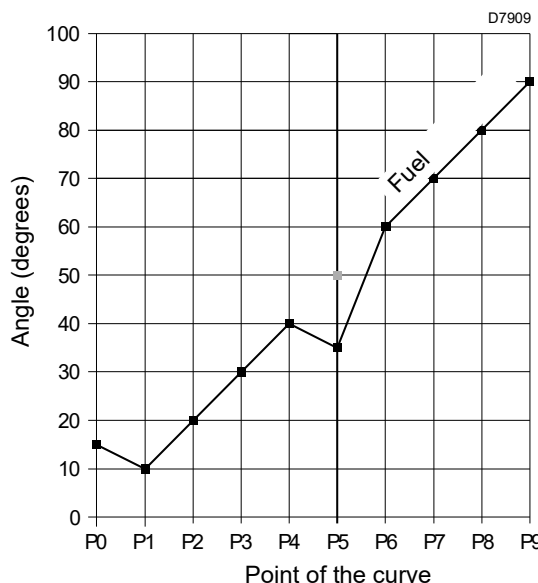
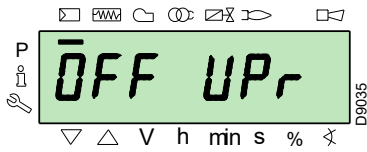

Fig. 35

5.8 Start-up procedure

Check that the operator panel display shows the heat request and “OFF Upr”: this means it is necessary to set the modulation curve of the burner.



Otherwise, modify the ignition point (see the section “Procedure for inserting and adjusting points on the modulation curve” on page 39.

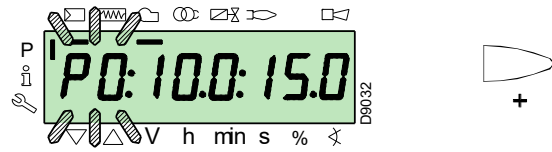

Access the Parameters Level referring to “Access procedure with password” on page 37. The display screen displays the parameters group 400.



The values shown in the figure are purely for indication purposes.

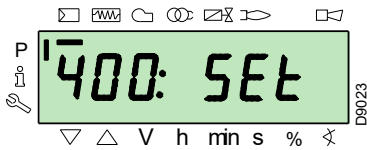

Phase 38:

The ignition phase begins and the spark goes off.

Phase 40:

The gas valves open (the count of the safety time begins). Using the appropriate visor check there is a flame and that the combustion parameters are correct. If necessary, vary the degrees of opening/closing of the air and fuel servomotors.

If the flame control goes into lockout, press the keys “+” and “-” (ESC) simultaneously: the display visualises alternately the lock-out code for flame absence **c: 4**) and the relative diagnostic (**d: 3**).

Confirm with the key “i/reset”



i/reset

The display shows “run”

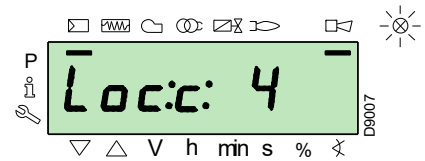
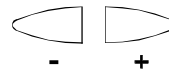
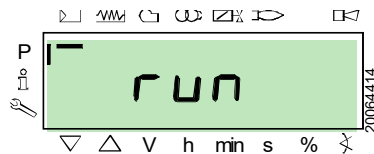

Confirm with the key “i/reset”. The burner starts up.

The display shows all the phases and relative times in sequence. The phases are listed in the section “List of phases” on page 17.

Phase 22:

Start of the fan motor.

Phase 24:

The burner goes to the pre-purging position, the air servomotor opens the damper at 90°.

Phases 80, 81, 82, 83:

These phases relate to the valve seal test.

Phase 30:

The count of the pre-purging time pre-set in the factory begins.

Phase 36:

The burner goes to its switch-on position, point “P0”, defined in Tab. N on page 41: the display shows a flashing “P0” indication.

If the value proposed is adequate, confirm using the “+” button.

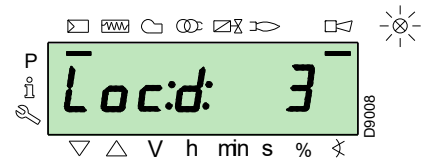

Solve the problem, referring to the paragraph “Ignition failure” on page 48.

To unlock, see “Reset procedure” on page 36. The display visualises “OFF Upr”.

Repeat the “Start-up procedure”.



The values previously inserted remain stored.

Once the ignition has occurred (point “P0”), proceed with the calibration of the modulation curve.

Press the button “+”: the display visualises the indicator “P1” flashing and proposes the same settings as point “P0”.

Press button “+” again: the display shows “CALC” for a few seconds.

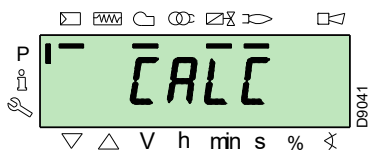

The flame control will automatically report the same values set in points “P0” and “P1” at points “P2” to “P8”.



IMPORTANT

The purpose of this is to reach point “P9” to regulate/determine the maximum operation output.

Press “+” until point “P9” is reached.

Once point “P9” is reached wait for the display to show the flashing indicator “P9” proposing the same settings as point “P0”.

Now it is possible to change this value to obtain the maximum operating power desired.

If the gas pressure is insufficient, despite opening the gas servomotor to a maximum of 90°, it is necessary to use the gas valve stabiliser.

After adjusting point “P9” keep the “-” key on the display pressed for about 5 seconds, “CALC” appears for a few seconds.

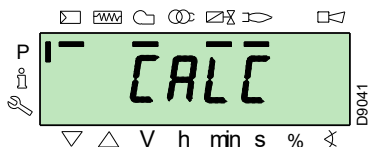

The flame control will automatically calculate the points from “P8” to “P2”, distributing them in a straight line. These are theoretical and must be checked.

Check that the settings of point “P8” are adequate.

If not, modify the point.

Proceed in sequence, with the “-” button, up to point “P1”.

It is possible to modify point “P1” to obtain a minimum modulation point different to the ignition point (“P0”).



IMPORTANT

Before moving on from one point to the next, wait for the servomotors to reach the position visualised on the display.

During the adjustment of each point, work on the air and gas servomotors, without modifying the position of the gas valve stabiliser.

Halfway through the procedure (i.e. around point P4 or P5), you are advised to measure gas delivery and check that the output is about 50% of the maximum output.

If this is not the case, work also on the gas valve stabiliser: in this case however, it is necessary to revise the calibrations of all the points previously set.

Once the calibration of point “P1” is completed, confirm by pressing the keys “+” and “-” (ESC) simultaneously: parameter “546” will appear.

If you want to make the burner work on the entire modulation curve, press the “+” and “-” (ESC) keys simultaneously: in this

way, parameter “546” will automatically be assigned the value of 100% and parameter “545” will have a value of 20%.

If you want to make the burner work on just a part of the modulation curve, modify the parameters “546” and “545” according to the “Parameter modification procedure” on page 38.

Press the keys “+” and “-” (ESC) simultaneously twice, the display will show the current load position.

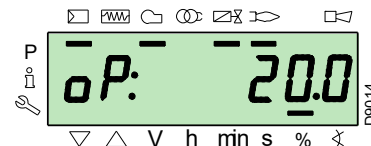
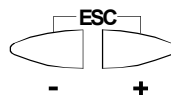

WARNING

At the end of the “Start-up procedure” it is necessary to carry out a “Backup”, which is used to memorise the parameters and the data in the flame control within the display RDI21...

This operation allows the parameters and the points of the modulation curve to be restored in the event of problems.

It is advisable to perform a backup every time that a parameter is changed!

For the procedure see “Backup” on page 42.

Factory settings

P0	Burner			
	RS 310	RS 410	RS 510	RS 610
air	15°	15°	15°	15°
gas	22°	22°	22°	22°

Tab. N

5.9 Backup / Restore procedure

At the end of the “**Start-up procedure**” it is wise to carry out a backup, creating a copy of the data memorised on the REC, in the RDI 21 display panel.

This will allow the data to be used for programming a new REC or to return to the memorised settings of the same REC.



We suggest that this operation be carried out at the end of any intervention that involves modifications to what has been set on the cam.

This will allow you to carry out a restore in a simple manner on a new cam supplied as a replacement part, without having to reprogramme the system.

5.9.1 Backup

To perform the backup, proceed as follows:

- access the Parameters Level referring to “Access procedure with password” on page 37.

The display screen displays the parameters group **400**.

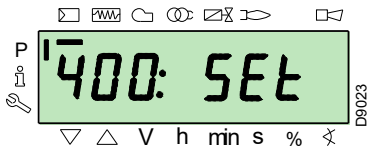

With the key “-”:



Select the parameters group **000**:

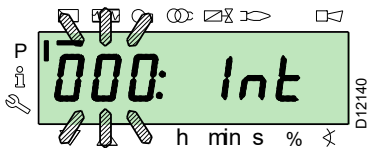

The **000** parameter blinks, confirm using the “**i/reset**” key:



i /reset

The display screen shows parameter **050** blinking:



Confirm with the key “**i/reset**”:



i /reset

The parameter **bAC_UP** appears on the display screen:

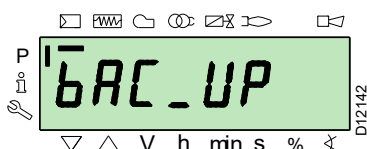

confirm with the key “**i/reset**”:



i /reset

The display screen shows the following value:

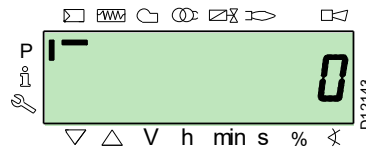

Use the button “+”:



The value will be set to **1**. Value 1 is flashing:

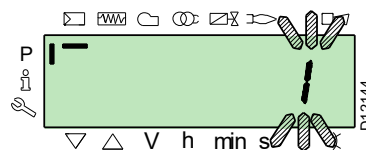

confirm with the button “**i/reset**” to activate the **backup** process.



i /reset

The value **1** appears on the display screen:

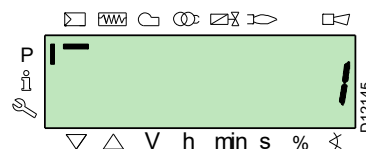

After approx 5 seconds (it depends on the duration of the programme), the 0 value appears on the display screen, this is to indicate that the backup process has been completed correctly.

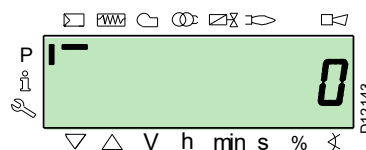

NOTE:

If an error occurs during the backup process, the display screen shows a negative value. Refer to diagnostic code 137 to determine the cause of the error (see section "List of parameters" on page 44).



It is advisable to perform a backup every time that a parameter is changed, after checking that the modification carried out is correct.

5.9.2 Restore



Use this procedure when replacing equipment with a parts code. In this way it is possible to have the default parameters already memorised or those memorised during the start-up.

This procedure cannot be carried out on equipment coming from other burners.

To perform the restore procedure, proceed as follows:

- access the Parameters Level referring to "Access procedure with password" on page 37.

The display screen displays the parameters group **400**.

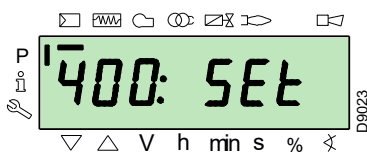

With the key "-":



Select the parameters group **000**:

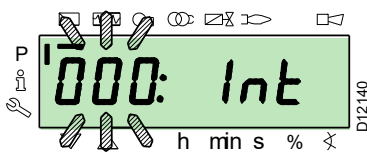

The **000** parameter blinks, confirm using the "i/reset" key:



i/reset

The display screen shows parameter **050** blinking:

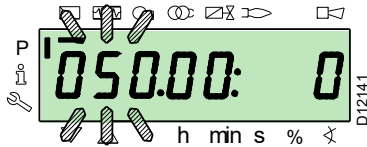

Confirm with the key "i/reset":



i/reset

The parameter **bAC_UP** appears on the display screen:

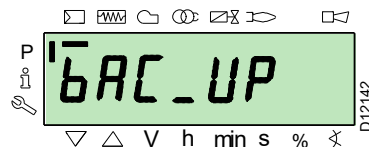

With the key "+"



select the **rEStorE** parameter

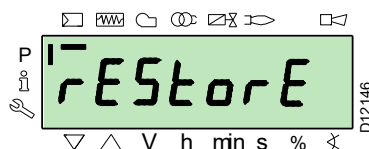

Confirm with the key "i/reset":



i/reset

The display shows the following value.



Use the button "+":



The value will be set to **1**. Value 1 is flashing:

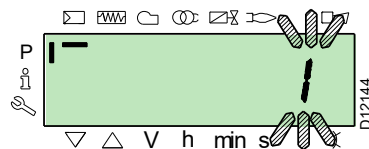

confirm with the button "i/reset" to activate the **restore** process.



i/reset

The value **1** appears on the display screen:

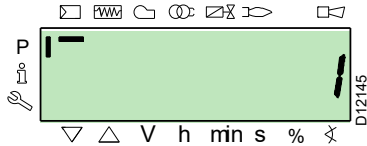

After approx 8 seconds (it depends on the duration of the programme), the **0** value appears on the display screen, this is to indicate that the restore process has been completed correctly.



NOTE:

When the restore process is successfully completed, the **0** value is shown on the display screen. Err C information: 136 D: 1 (restore process initialised) is displayed for a brief moment.



At the end of the restore process, it is necessary to check the sequence of functions and the list of parameters.

5.9.3 List of parameters

Parameter		No. of elements	Unit of measurement	Modification	Values interval		Degree of precision	Predefined setting	Access mode
No.	Description				Min.	Max.			
000 INTERNAL PARAMETERS									
050	Start backup/restore process via RDI21... / PC TOOL (set the parameter to 1) Index 0 = create backup Index 1 = perform restore Negative values indicate errors	2	-	Modification	-99	2	1	0; 0	Service mode
055	Burner identification number created from the backup on RDI21...	1	-	Reading only	0	99999999	1	0	Service mode
056	ASN number created by the backup on RDI21...	8	-	Reading only	0	127	1	0	Service mode
057	Software Version created by the backup on RDI21...	1	-	Reading only	0x100	0xFFFF9	1	0	Service mode
100 GENERAL PARAMETERS									
102	Flame control identification date	1	-	Reading only	0	255	1		Info mode
103	Flame control identification number	1	-	Reading only	0	65535	1		Info mode
104	Identification number of the group of parameters set	1	-	Reading only	0	255	1	30	Info mode
105	Version of the group of parameters set	1	-	Reading only	0	0xFFFF	1	V01.08	Info mode
107	Software version	1	-	Reading only	0	0xFFFF9	1	V03.30	Info mode
108	Software variation	1	-	Reading only	0	225	1	1	Info mode
111	ASN number to verify the ASN number created by the backup on RDI 21...	8	-	Reading only	0	127	1	0	Service mode
113	Burner identification	1	-	Modification	0	99999999	1	Not defined	Info Mode with password Service Mode
121	Manual setting of output Not defined = automatic operation	1	%	Modification / zero setting	0%	100%	0.1%	Not defined	Info mode
123	Minimum output step position Index 0: BACS output Index 1: output of the external load regulator, analogue. Index 2: output of the external load regulator contacts.	3	%	Modification	0%	100%	0.1%	0%; 1%; 0%	Service mode
124	Beginning flame loss test (TÜV test)(define the parameter at 1)(switch of flame loss fuel valves) A negative value indicates an error (see code 150)	1	-	Modification	-6	1	1	0	Service mode
125	Frequency of main power supply 0 = 50 Hz 1 = 60 Hz	1	-	Modification	0	1	1	0	Service Mode
126	Brightness of display	1	%	Modification	0%	100%	1%	75%	Service Mode
128	Fuel meter: Led pulse valence (led pulses / volumetric flow units)	1	-	Modification	0	400	0,01	0	Service Mode
130	Eliminate visualisation error chronology To eliminate the visualisation, set the parameter to 1, then to 2 Answer 0: process successful Answer -1: timeout of 1_2 - sequence	1	-	Modification	-5	2	1	0	Service Mode

Parameter		No. of elements	Unit of measurement	Modification	Values interval		Degree of precision	Predefined setting	Access mode
No.	Description				Min.	Max.			
133	Default output for TÜV test: Not valid for TÜV test when output is activated 2,000 10,000 = low flame or first / second / third stage	1	%	Modification / zero setting	20%	100%	0.1%	Not defined	Service Mode
141	Remote management of flame control 0 = off 1 = Modbus 2 = reserved	1	-	Modification	0	2	1	0	Service Mode
142	Standby time before a new attempt in event of communication fault Set values: 0 = not active 1 = 7200 s	1	s	Modification	0s	7200s	1s	120s	Service Mode
143	Reserved	1	-	Modification	1	8	1	1	Info Mode
144	Reserved	1	s	Modification	10s	60s	1s	30s	Service Mode
145	Peripheral address for Modbus Set values: 1 ... 247	1	-	Modification	1	247	1	1	Service Mode
146	Baud Rate for Modbus Set values: 0 = 9600 1 = 19200	1	-	Modification	0	1	1	1	Service Mode
147	Parity for Modbus 0 = none 1 = odd 2 = even	1	-	Modification	0	2	1	0	Service Mode
148	Selection of the burner operation during the interruption of the switch-over with the system of remote management. Set values: With modulating operation the settings of the values are the following: 0...19.9 = burner switched off 20...100 = 20...100% modulation field of the burner. With stage operation : 0 = burner off P1, P2, P3 No setting = no function in the event of communication interruption	1	%	Modification / zero setting	0%	100%	0.1%	Not defined	Service Mode
161	Total number of errors	1	-	Reading only	0	65535	1	0	Info mode
162	Hours of operation (that can be reset)	1	h	Reset	0 h	999999h	1 h	0h	Info mode
163	Total hours of power supply to flame control	1	h	Reading only	0h	999999h	1h	0h	Info mode
164	Total number of start-ups (that can be reset)	1	-	Reset	0	999999	1	0	Info mode
166	Total number of start-ups	1	-	Reading only	0	999999	1	0	Info mode
167	Volumetric delivery of fuel in the selected unit of measurement (that can be reset)	1	m ³ , l, ft ³ , gal	Reset	0	99999999	1	0	Info mode
200 BURNER CHECKS									
201	Burner operation mode (fuel supply line, modulating/ stage, servomotors, etc.) -- = not defined (eliminate curves) 1 = Gmod 2 = Gp1 mod 3 = Gp2 mod 4 = Lo mod 5 = Lo 2 stage 6 = Lo 3 stage 7 = Gmod pneu 8 = Gp1 mod pneu 9 = Gp2 mod pneu 10 = LoGp mod 11 = LoGp 2-stage 12 = Lo mod 2 fuel valves 13 = LoGp mod 2 fuel valves 14 = G mod pneu without actuator 15 = Gp1 mod pneu without actuator 16 = Gp2 mod pneu without actuator 17 = Lo 2-stage without actuator 18 = Lo 3-stage without actuator 19 = G mod only gas actuator 20 = Gp1 mod only gas actuator 21 = Gp2 mod only gas actuator 22 = Lo mod only oil actuator	1	-	Modify/set to zero	1	22	1	Not defined	Service Mode

Parameter		No. of elements	Unit of measurement	Modification	Values interval		Degree of precision	Predefined setting	Access mode
No.	Description				Min.	Max.			
208	Stopping of the program 0 = deactivated 1 = pre-purging (Ph24) 2 = Ignition (Ph36) 3 = Interval 1 (Ph44) 4 = Interval 2 (Ph52)	1	-	Modification	0	4	1	0	Service Mode
210	Alarm as the pre-purging phase begins; 0 = Deactivated; 1 = Activated	1	-	Modification	0	1	1	0	Service Mode
211	Uphill train fan motor	1	s	Modification	2s	60s	0.2s	2s	Service Mode
212	Maximum time to reach low flame	1	s	Modification	0.2s	10 min	0.2s	45s	Service Mode
215	Maximum repeats of safety circuit 1 = No repetition 2...15 = Number of repetitions 16 = Constant repetitions	1	-	Modification	1	16	1	16	Service Mode
221	Gas: selection of flame sensor 0 = QRB.../ QRC 1 = ION / QRA	1	-	Modification	0	1	1	1	Service Mode
222	Gas: Selection of the pre-purging function 0 = deactivated 1 = activated	1	-	Modification	0	1	1	1	Service Mode
223	Maximum repeats of minimum gas pressure switch intervention 1 = No repetition 2...15 = Number of repetitions 16 = Constant repetitions	1	-	Modification	1	16	1	16	Service Mode
225	Gas: pre-purging time	1	s	Modification	20s	60 min	0.2s	20s	Service Mode
226	Gas: pre-ignition time	1	s	Modification	0.4 s	60 min	0.2s	2s	Service Mode
230	Gas: interval 1	1	s	Modification	0.4 s	60s	0.2s	2s	Service Mode
232	Gas: interval 2	1	s	Modification	0.4 s	60s	0.2s	2s	Service Mode
233	Gas: post-combustion time	1	s	Modification	0.2s	60s	0.2s	8s	Service Mode
234	Gas: Post-purging time (no extraneous light test)	1	s	Modification	0.2s	108 min	0.2s	0.2s	Service Mode
236	Gas: Minimum gas pressure switch input 0 = deactivated 1 = minimum gas pressure switch (upstream of the fuel valve 1 (V1)) 2 = valve control via the minimum pressure switch (between fuel vale 1 (V1) and 2 (V2))	1	-	Modification	1	2	1	1	Service Mode
237	Gas: Maximum gas pressure switch / POC Input 0 = deactivated 1 = Maximum gas pressure switch 2 = POC	1	-	Modification	1	2	1	1	Service Mode
241	Gas: Valve leak detection test 0 = test deactivated 1 = valve leak detection test at start up 2 = valve leak detection test at shutdown 3 = valve leak detection test at start-up and at shutdown	1	-	Modification	0	3	1	2	Service Mode
248	Gas: Post-purging time (t3)(at deactivation of the load (LR)) - ON	1	s	Modification	1s	108 min	0.2s	1s	Service Mode
261	Oil: selection of flame sensor 0 = QRB.../ QRC... 1 = ION / QRA...	1	-	Modification	0	1	1	0	Service Mode
265	Oil: pre-purging time	1	s	Modification	15s	60 min	0.2s	15s	Service Mode
266	Oil: pre-ignition time	1	s	Modification	0.6s	60 min	0.2s	2s	Service Mode
270	Oil: interval 1	1	s	Modification	0.4 s	60 min	0.2s	2s	Service Mode
272	Oil: interval 2	1	s	Modification	0.4 s	60 min	0.2s	2s	Service Mode
273	Oil: post-combustion time	1	s	Modification	0.2s	60s	0.2s	8s	Service Mode
274	Oil: Post-purging time (no extraneous light test)	1	s	Modification	0.2s	108 min	0.2s	0.2s	Service Mode
276	Oil: Minimum input oil pressure switch 0 = deactivated 1 = activated from phase 38 2 = activated from safety time (TSA)	1	-	Modification	1	2	1	1	Service Mode
277	Oil: Maximum oil pressure switch / POC Input 0 = deactivated 1 = Maximum oil pressure switch 2 = POC	1	-	Modification	1	2	1	1	Service Mode

Parameter		No. of elements	Unit of measurement	Modification	Values interval		Degree of precision	Predefined setting	Access mode
No.	Description				Min.	Max.			
281	Oil: selection transformer ignition phase TA 0 = brief pre-ignition (Ph38) 1 = long pre-ignition (with fan)(Ph22)	1	-	Modification	0	1	1	1	Service Mode
284	Oil: Post-purging time (t3)(at deactivation of the load (LR)) - ON	1	s	Modification	1s	108 min	0.2s	1s	Service Mode
400 AIR / FUEL MODULATION CURVES									
401	Checking fuel servomotor (only setting of the curve)	13	(°)	Modification	0°	90°	0.1°	0°; 0°; 15°; Not defined	Service Mode
402	Checking air servomotor (only setting of the curve)	13	(°)	Modification	0°	90°	0.1°	0°; 90°; 45°; Not defined	Service Mode
500 POSITIONING OF SERVOMOTORS									
501	Position of the fuel servomotor in absence of flame Index 0 = standby position Index 1 = pre-purging position Index 2 = post-purging position	3	(°)	Modification	0°	90°	0.1°	0°; 0°; 15°	Service Mode
502	Position of the air servomotor in absence of flame Index 0 = standby position Index 1 = pre-purging position Index 2 = post-purging position	3	(°)	Modification	0°	90°	0.1°	0°; 90°; 45°	Service Mode
545	Minimum modulation limit Not defined = 20%	1	%	Modification / zero setting	20%	100%	0.1%	Not defined	Service Mode
546	Maximum modulation limit Not defined = 100%	1	%	Modification / zero setting	20%	100%	0.1%	Not defined	Service Mode
600 SERVOMOTORS									
606	Tolerance limit for position check (0.1°) Index 0 = fuel Index 1 = air More serious position error, where a defect has certainly been detected -> Stop range: (P 606 - 0.6°) a P606	2	(°)	Modification	0.5°	4°	0.1°	1.7°; 1.7°	Service Mode
645	Analogue exit configuration 0 = DC 0...10 V 1 = DC 2...10 V 2 = DC 0 / 2...10 V	1	-	Modification	0	2	1	2	Service Mode
700 LOG OF THE ERRORS									
701	Error chronology: 701-725.01.Code	25	-	Reading only	0	255	1	0	Info mode
•	Error chronology: 701-725.02.Diagnostic code	25	-	Reading only	0	255	1	0	Info mode
•	Error chronology: 701-725.03.Error class	25	-	Reading only	0	6	1	0	Info mode
•	Error chronology: 701-725.04.Phase	25	-	Reading only	0	255	1	0	Info mode
•	Error chronology: 701-725.05.Start-up meter	25	-	Reading only	0	99999999	1	0	Info mode
725	Error chronology: 701-725.06.Load	25	%	Reading only	0%	100%	0.1%	0%	Info mode
900 PROCESS INFORMATION									
903	Actual output Index 0 = fuel Index 1 = air	2	%	Reading only	0%	100%	0.1%	0%	Info mode
922	Position of the servomotors Index 0 = fuel Index 1 = air	2	(°)	Reading only	-50°	150°	0.01°	0°	Info mode
942	Heat source active 1 = output during the definition of the curves 2 = manual output 3 = BACS output 4 = analogue input output 5 = output of the external load regulator contacts	1	-	Reading only	0	255	1	0	Service mode
947	Result of the sampling of the contact (codified in bits) Bit 0.0 = 1: Minimum pressure switch Bit 0.1 = 2: Maximum pressure switch Bit 0.2 = 4: Pressure switch control valves Bit 0.3 = 8: Air pressure switch Bit 0.4 = 16: Open load check Bit 0.5 = 32: ON load check Bit 0.6 = 64: Closed load check Bit 0.7 = 128: Safety circuit Bit 1.0 = 1: Safety valve Bit 1.1 = 2: Ignition Bit 1.2 = 4: Fuel valve 1 Bit 1.3 = 8: Fuel valve 2 Bit 1.4 = 16: Fuel valve 3/ pilot valve Bit 1.5 = 32: Reset	2	-	Reading only	0	255	1	0	Info mode

Parameter		No. of elements	Unit of measurement	Modification	Values interval		Degree of precision	Predefined setting	Access mode
No.	Description				Min.	Max.			
950	Relay request status (coded in bits) Bit 0 = 1: Alarm Bit 1 = 2: Safety valve Bit 2 = 4: Ignition Bit 3 = 8: Fuel valve 1 Bit 4 = 16: Fuel valve 2 Bit 5 = 32: Fuel valve 3/ pilot valve	1	-	Reading only	0	255	1	0	Info mode
954	Flame intensity	1	%	Reading only	0%	100%	1%	0%	Info mode
960	Actual output	1	m ³ /h, l, h, ft ³ /h, gal/h	Reading only	0	6553,5	0,1	0	Info mode
961	Status of external modules and visualisation	1	-	Reading only	0	255	1	0	Info mode
981	Memory error: Code	1	-	Reading only	0	255	1	0	Info mode
982	Memory error: diagnostic code	1	-	Reading only	0	255	1	0	Info mode
992	Error indicators	10	-	Reset	0	0xFFFFFFFF FF	1	0	Service mode

Tab. O

5.10 Operation

Burner without modulating operation kit

Once the start-up cycle is completed, the servomotor command moves on to the thermostat/pressure switch TR that controls the pressure or the temperature in the boiler.

- If the temperature or the pressure is low (so the thermostat/pressure switch TR is closed), the burner progressively increases the output as far as the MAX value (point "P9").
- If the temperature or the pressure increases as far as the opening of the thermostat/pressure switch TR, the burner progressively reduces the output as far as the MIN value (point "P1"). The sequence repeats endlessly.
- The burner stops when the heat request is less than the heat supplied by the burner at MIN output.

- The thermostat/pressure switch TL opens, the flame control carries out the switching off phase.
- The air damper closes completely to reduce heat losses to a minimum.

Burner without the kit for modulating operation (only FS2 models)

As an alternative to control through TR, the command for burner modulation can be made also using a 4-20 mA signal.

Burner with modulating operation kit

See manual enclosed with the adjuster kit.

5.11 Motor lockout

If the motor does not start, it could be because of a thermal relay intervention due to its incorrect calibration or problems with the motor or the main power supply, to release press the button of the thermal relay, see "Calibration of the thermal relay" on page 20.

5.12 Ignition failure

If the burner does not switch on, there is a lockout within 3s of the electrical supply reaching the gas valve.

It may be that the gas does not arrive at the combustion head within the safety time of 3s.

In this case increase gas ignition flow rate. The arrival of gas to the pipe coupling is displayed on the pressure gauge, as shown in (Fig. 37 on page 51).



WARNING

In the event the burner stops, in order to prevent any damage to the installation, do not unblock the burner more than twice in a row.

If the burner locks out for a third time, contact the customer service.



DANGER

In the event there are further lockouts or faults with the burner, the maintenance interventions must only be carried out by qualified, authorised personnel, in accordance with the contents of this manual and in compliance with the standards and regulations of current laws.

5.13 Burner flame goes out during operation

If the flame should go out during operation, the burner will lockout within 1s.

5.14 Stopping of the burner





The burner can be stopped by:

- intervening on the disconnecting switch of the electrical supply line, located on the boiler panel;
- removing the transparent protection 30)(Fig. 4 on page 12), after unscrewing the relative screw.

There are now two possibilities:

- using the operator panel according to the manual lockout procedure on page 35;
- using the switch 0-1 of Fig. 28 on page 31.

5.15 Final checks (with burner operating)

<ul style="list-style-type: none"> ➤ Open the thermostat/pressure switch TL ➤ Open the thermostat/pressure switch TS 		The burner must stop
<ul style="list-style-type: none"> ➤ Turn the gas maximum pressure switch knob to the minimum end of scale position ➤ Turn the air pressure switch knob to the maximum end of scale position 		The burner must stop in lockout
<ul style="list-style-type: none"> ➤ Turn off the burner and cut off the power ➤ Disconnect the minimum gas pressure switch connector 		The burner must not start
<ul style="list-style-type: none"> ➤ Disconnect the connector of the ionisation probe 		The burner must stop in lockout due to ignition failure

Tab. P



Make sure that the mechanical locking systems on the various adjustment devices are fully tightened.

6 Maintenance

6.1 Notes on safety for the maintenance

The periodic maintenance is essential for the good operation, safety, yield and duration of the burner.

It allows you to reduce consumption and polluting emissions and to keep the product in a reliable state over time.



The maintenance interventions and the calibration of the burner must only be carried out by qualified, authorised personnel, in accordance with the contents of this manual and in compliance with the standards and regulations of current laws.

Before carrying out any maintenance, cleaning or checking operations:



Disconnect the electrical supply from the burner by means of the main system switch.



Turn off the fuel interception tap.



Wait for the components in contact with heat sources to cool down completely.

6.2 Maintenance programme

6.2.1 Maintenance frequency



The gas combustion system should be checked at least once a year by a representative of the manufacturer or another specialised technician.

6.2.2 Safety test - with gas feeding closed

For its safe commissioning it is very important to make sure that the electrical wiring has been carried out correctly between the gas valves and the burner.

To this end, after checking that the connections have been made in conformity with the burner's wiring diagram, a starting cycle should be carried out with the gas tap closed (dry test).

- 1 The manual gas valve should be closed with the locking/releasing device ("lock-out / tag out" procedure).
- 2 Make sure the limit electric contacts of the burner close
- 3 Make sure the contact of the minimum gas pressure switch closes
- 4 Proceed with a tentative start up of the burner.

The starting cycle should occur with the following phases:

- Starting the fan motor for pre-purging
- Carrying out the gas valve leak detection control, if applicable
- Completing the pre-purging
- Reaching the ignition point
- Power supply of the ignition transformer
- Power supply the gas valves.

Since the gas is closed, the burner will not be able to start and its flame control will stop or go into a safety lockout.

The effective supplying of the gas valves can be checked with the insertion of a tester; some valves are fitted with light signals (or closure/opening position indicators) that are activated when the electrical supply arrives.



IF THE ELECTRICAL SUPPLY OF THE GAS VALVES OCCURS AT AN UNEXPECTED MOMENT, DO NOT OPEN THE MANUAL VALVE, DISCONNECT THE ELECTRICAL SUPPLY, CHECK THE WIRING; CORRECT THE ERRORS AND CARRY OUT THE ENTIRE TEST AGAIN.

6.2.3 Checking and cleaning



The operator must use the required equipment during maintenance.

Combustion

The optimum calibration of the burner requires an analysis of the flue gases.

Significant differences with respect to the previous measurements indicate the points where most care should be exercised during maintenance.

Combustion head

Open the burner and make sure that all components of the combustion head are in good condition, not deformed by the high temperatures, free of impurities from the surroundings and correctly positioned.

Burner

Check that there are not excess wear or loosen screws.

Clean the outside of the burner.

Fan

Check to make sure that no dust has accumulated inside the fan or on its blades, as this condition will cause a reduction in the air flow rate and provoke polluting combustion.

Boiler

Clean the boiler as indicated in its accompanying instructions in order to maintain all the original combustion characteristics intact, especially the flue gas temperature and combustion chamber pressure.

Gas leaks

Make sure that there are no gas leaks on the pipe between the gas meter and the burner.

Gas filter

Change the gas filter when it is dirty.

Combustion

If the combustion values measured before starting maintenance do not comply with applicable legislation or do not indicate efficient combustion, consult the Tab. Q or contact our Technical Support Service to implement the necessary adjustments. It is advisable to set the burner according to the type of gas used and following the indications in Tab. Q.

EN 676		Air excess			
		Max. output $\lambda \leq 1.2$		Min. output $\lambda \leq 1.3$	
GAS	CO ₂ theoretical max. 0% O ₂	CO ₂ % Calibration		CO	NO _x
		$\lambda = 1.2$	$\lambda = 1.3$	mg/kWh	mg/kWh
G 20	11.7	9.7	9.0	≤ 100	≤ 170
G 25	11.5	9.5	8.8	≤ 100	≤ 170
G 30	14.0	11.6	10.7	≤ 100	≤ 230
G 31	13.7	11.4	10.5	≤ 100	≤ 230

Tab. Q

6.2.4 Measuring the ionisation current

The burner is fitted with an ionisation system to check that a flame is present. The minimum current for flame control operation is 4 µA. The operator panel displays “30%” (see “List of parameters” on page 44, parameter no. 954).

The burner provides a much higher current, so controls are not normally required. However, if it is necessary to measure the ionisation current, disconnect the plug-socket on the ionisation probe cable and insert a direct current microammeter with a base scale of 100 µA, as shown in Fig. 36.



Carefully check the polarities!

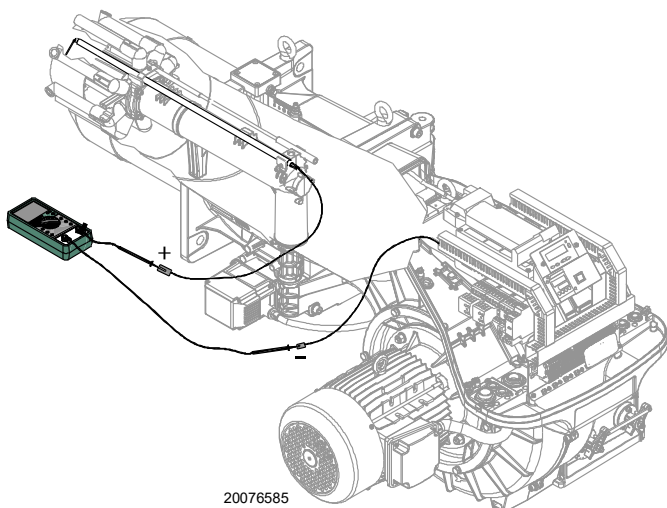

Fig. 36

6.2.5 Checking the air and gas pressure on the combustion head

To carry out this operation it is necessary to use a pressure gauge to measure the air and gas pressure at the combustion head, as shown in Fig. 37.

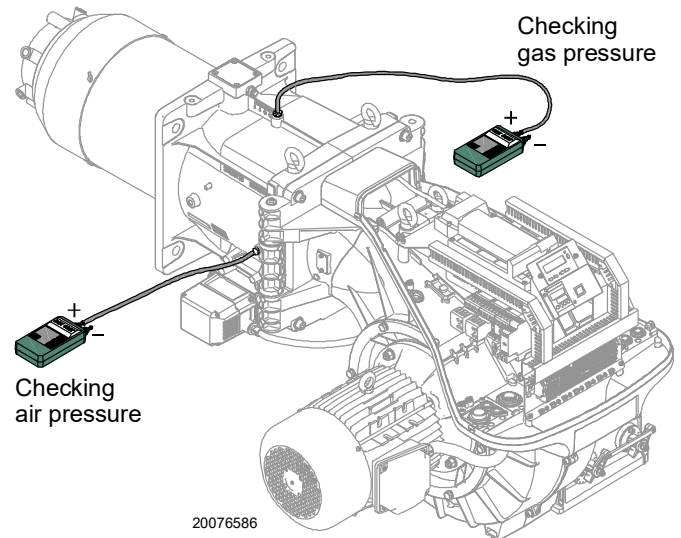

Fig. 37

6.2.6 Safety components

The safety components should be replaced at the end of their life cycle indicated in the following table.

The specified life cycles do not refer to the warranty terms indicated in the delivery or payment conditions.

Safety component	Life cycle
Flame control	10 years or 250.000 operation cycles
Flame sensor	10 years or 250.000 operation cycles
Gas valves (solenoid)	10 years or 250.000 operation cycles
Pressure switches	10 years or 250.000 operation cycles
Pressure adjuster	15 years
Servomotor (electronic cam) (if present)	10 years or 250.000 operation cycles
Oil valve (solenoid) (if present)	10 years or 250.000 operation cycles
Oil regulator (if present)	10 years or 250.000 operation cycles
Oil pipes/ couplings (metallic) (if present)	10 years
Fan impeller	10 years or 500.000 start-ups

Tab. R

6.3 Opening the burner



Disconnect the electrical supply from the burner by means of the main system switch.



Wait for the components in contact with heat sources to cool down completely.



Turn off the fuel interception tap.

To open the burner, use the same procedure set out in “Access to head internal part” on page 23.

6.4 Closing the burner

Refit following the steps described but in reverse order; refit all burner components as they were originally assembled.



After carrying out maintenance, cleaning or checking operations, reassemble the cover and all the safety and protection devices of the burner.

7 Faults - Possible causes - Solutions

If faults arise in ignition or operations, the burner performs a "safety stop", which is signalled by the red burner lockout LED.

The display of the operator panel visualises alternately the lock-out code and the relative diagnostic.

To restore start-up conditions, refer to the "Reset procedure" on page 36.

When the burner starts up again, the red LED goes out.



In the event of a burner lockout, more than two consecutive burner reset operations could cause damage to the installation. On the third lockout, contact the Aftersales Service.



If further lockouts or burner faults occur, interventions must only be made by qualified, authorised personnel (as indicated in this manual, and in compliance with the laws and regulations currently in force).

7.1 Error codes list

Error code	Diagnostic code	Meaning of the REC 27.100A2 system	Recommended measures
No Comm		No communication between REC 27.100A2 and RDI21...	Check the wiring between the flame control REC 27.100A2 and the display RDI21...
2	#	No flame at the end of TSA1	
	1	No flame at the end of safety time 1 (TSA1)	
	2	No flame at the end of safety time 2 (TSA2)	
	4	No flame at the end of safety time 1 (TSA1) (software version ≤ V02.00)	
3	#	Air pressure error	
	0	Air pressure switch off	
	1	Air pressure switch on	
	4	Air pressure on – Lockout alarm at start	
	20	Air pressure, fuel pressure on - Alarm lock at start	
	68	Air pressure, POC on – Alarm lockout at start	
	84	Air pressure, fuel pressure, POC on - Alarm lockout at start	
4	#	Extraneous light	
	0	Extraneous light during start-up	
	1	Extraneous light during switch-off	
	2	Extraneous light during start-up – Lockout alarm at start	
	6	Extraneous light during start-up, air pressure - Alarm lockout at start	
	18	Extraneous light during start-up, fuel pressure - Alarm lockout at start	
	24	Extraneous light during start-up, air pressure, fuel pressure - Alarm lockout at start	
	66	Extraneous light during start-up, POC – Alarm lockout at start	
	70	Extraneous light during start-up, air pressure, POC - Alarm lockout at start	
	82	Extraneous light during start-up, fuel pressure, POC - Alarm lockout at start	
	86	Extraneous light during start-up, air pressure, fuel pressure, poc - Alarm lockout at start	
7	#	Loss of flame	
	0	Loss of flame	
	3	Flame loss (software version ≤ V02.00)	
	3...255	Flame loss during TÜV test (flame loss test)	The diagnostics covers the period of time from the closure of the fuel valves at the point the flame loss was detected (resolution 0.2 s → value 5 = 1 s).
12	#	Valve leak detection control:	
	0	V1 leaks	<u>Leak test</u> Check if the valve on the side of the gas has any leaks. Check the wiring and check that the circuit is open.
	1	V2 leaks	<u>Leak test</u> Check if the valve on the side of the burner has any leaks. Check if the pressure switch for the leak test (PGVP) is closed when gas pressure is not present. Check the wiring and check if there is any short-circuit.

Error code	Diagnostic code	Meaning of the REC 27.100A2 system	Recommended measures
	2	Valve leak detection test not possible	The valve leak detection is active, but the minimum gas pressure switch is selected as input for X9-04 (check parameters 238 and 241)
	3	Valve leak detection test not possible	The valve leak detection is active, but no input has been assigned (check parameters 236 and 237)
	4	Valve leak detection not possible	Valve leak detection is active, but 2 inputs have already been assigned (configure parameter 237 or maximum gas Pressure switch or POC)
	5	Valve leak detection not possible	The valve leak detection is active, but 2 inputs have been assigned (check parameters 236 and 237)
14	#	POC	
	0	POC Open	Check if the closure contact of the valve is closed
	1	POC Closed	Check the wiring Check if the closure contact of the valve opens when the valve is checked
	64	POC Open - Alarm lockout at start	Check the wiring Check if the closure contact of the valve is closed
19	80	Fuel pressure, POC - Alarm lockout at start	Check that the pressure switch is closed when no pressure is present from the fuel Check that there are no short-circuits
20	#	Pmin	
	0	Minimum gas/oil pressure absent	Check that there are no line interruptions
	1	Scarcity of gas - Alarm lockout at start	Check that there are no line interruptions
21	#	Pmax/POC	
	0	Pmax: Max. gas/oil pressure exceeded POC: POC open (software version ≤ V02.00)	Check the wiring. POC: check if the closure contact of the valve is closed
	1	POC closed (software version ≤ V02.00)	Check the wiring. Check if the closure contact of the valve opens when the valve is checked
	64	POC Open - Alarm lockout at the start (software version ≤ V02.00)	Check the wiring. Check if the contact of the valve opens when the valve is checked
22 OFF S	#	Safety circuit/Burner flange	
	0	Safety circuit open /Burner flange open	
	1	Safety circuit open /Burner flange open - Alarm lockout at start	
	3	Safety circuit open /Burner flange open, extraneous light - Alarm lockout at start	
	5	Safety circuit open /Burner flange open, extraneous light - Alarm lockout at start	
	17	Safety circuit open /Burner flange open, extraneous light - Alarm lockout at start	
	19	Safety circuit open /Burner flange open, extraneous light - Alarm lockout at start	
	21	Safety circuit open /Burner flange open, extraneous light - Alarm lockout at start	
	23	Safety circuit open /Burner flange open, extraneous light, air pressure, fuel pressure - Alarm lockout at start	
	65	Safety circuit /Burner flange open, POC - Alarm lockout at start	
	67	Safety circuit open /Burner flange open, extraneous light, POC - Alarm lockout at start	
	69	Safety circuit open /Burner flange open, air pressure, POC - Alarm lockout at start	
	71	Safety circuit open /Burner flange open, extraneous light, air pressure, POC - Alarm lockout at start	
	81	Safety circuit open /Burner flange open, fuel pressure, POC - Alarm lockout at start	
	83	Safety circuit open /Burner flange open, extraneous light, air pressure, POC - Alarm lockout at start	
	85	Safety circuit open /Burner flange, air pressure, fuel pressure, POC - Alarm lockout at start	
	87	Safety circuit open /Burner flange, extraneous light, air pressure, fuel pressure, POC - Alarm lockout at start	

Error code	Diagnostic code	Meaning of the REC 27.100A2 system	Recommended measures
50 ÷ 58	#	Internal error	Carry out a reset; if the error arises repeatedly, replace the flame control
60	0	Internal error: no valid load checking device	Carry out a reset; if the error arises repeatedly, replace the flame control
65 ÷ 67	#	Internal error	Carry out a reset; if the error arises repeatedly, replace the flame control
70	#	Fuel/air checking error: Calculation position in modulation	
	23	Invalid load	No valid load
	26	Curve points not defined	Adjust the curve points of all the actuators
71	#	Special position not defined	
	0	Standby position	Set the standby position of all the servomotors used
	1	Pre-purging position	Set the pre-purging position of all the servomotors used
	2	Post-purging position	Set the post-purging position of all the servomotors used
	3	Ignition position	Set the ignition position of all the servomotors used
72	#	Fuel/air internal checking error:	Carry out a reset; if the error arises repeatedly, replace the flame control
73	#	Fuel/air internal checking error: multistep calculation position	
	23	Position calculation, invalid stage load	No valid load
	26	Position calculation, stage curve points not defined	Adjust the curve points of all the servomotors
75	#	Fuel/air ratio internal checking error: cyclical data check	
	1	Check synchronisation data, different current load	
	2	Check synchronisation data, different target load	
	4	Check synchronisation data, different target positions	
	16	Check synchronisation data, different positions reached	
76	#	Fuel/air internal checking error:	Carry out a reset; if the error arises repeatedly, replace the flame control
85	#	Reference error of a servomotor	
	0	Reference error of the fuel servomotor	The reference of the fuel servomotor was not successful. It was not possible to reach the reference point. 1. Check if the servomotors have been inverted. 2. Check if the servomotor is blocked or overloaded.
	1	Reference error of the air servomotor	The reference of the air servomotor was not successful. It was not possible to reach the reference point. 1. Check if the servomotors have been inverted. 2. Check if the servomotor is blocked or overloaded.
	Bit 7 Valence ≥ 128	Reference error owing to parameter modification	The parameterisation of an actuator (e.g. the reference position) has been modified. This error will be visualised to start up a new reference.
86	#	Fuel servomotor error	
	0	Position error	It was not possible to reach the target position within the requested tolerance range. 1. Check if the servomotor is blocked or overloaded.
	Bit 0 Valence 1	Circuit open	Circuit open shown on the servomotor connection. 1. Check the wiring (the voltage between pin 5 or 6 and 2 of the X54 connector must be > 0.5 V).
	Bit 3 Valence ≥ 8	Curve too steep in terms of train ratio	The slope of the curve can correspond to a maximum position modification of 31° between 2 points of the modulation curve.
	Bit 4 Valence ≥ 16	Deviation of section compared with the last reference	Overloading of the servomotor or servomotor subjected to mechanical torsion. 1. Check if the servomotor is blocked in any point along its range of action. 2. Check if the torque is sufficient for the application.
87	#	Air servomotor error	
	0	Position error	It was not possible to reach the target position within the requested tolerance range. 1. Check if the servomotor is blocked or overloaded.
	Bit 0 Valence 1	Circuit open	Circuit open shown on the servomotor connection. 1. Check the wiring (the voltage between pin 5 or 6 and 2 of the X54 connector must be > 0.5 V).
	Bit 3 Valence ≥ 8	Curve too steep in terms of train ratio	The slope of the curve can correspond to a maximum position modification of 31° between 2 points of the modulation curve.

Error code	Diagnostic code	Meaning of the REC 27.100A2 system	Recommended measures
	Bit 4 Valence ≥ 16	Deviation of section compared with the last reference	Overloading of the servomotor or servomotor subjected to mechanical torsion. 1. Check if the servomotor is blocked in any point along its range of action. 2. Check if the torque is sufficient for the application.
90 - 91	#	Burner internal checking error	
93	#	Flame signal acquisition error	
	3	Short circuit of the sensor	Short circuit in the QRB sensor... 1. Check the wiring. 2. Flame detector probably faulty.
95	#	Relay supervision error	
	3 Ignition transformer 4 Fuel valve 1 5 Fuel valve 2 6 Fuel valve 3	External power supply - Contact active	Check the wiring
96	#	Relay supervision error	
	3 Ignition transformer 4 Fuel valve 1 5 Fuel valve 2 6 Fuel valve 3	The relay contacts have joined together	Check the contacts: 1. flame control connected to the power supply: the fan output must be without voltage. 2. Disconnect the power supply. Disconnect the fan. The resistive connection between the fan output and the neutral wire is not allowed. If one of the 2 tests fails, replace the flame control because the contacts are definitively joined together and it is no longer possible to guarantee safety.
97	#	Relay supervision error	
	0	The safety relay contacts have joined together or the safety relay has been powered by an external power supply	Check the contacts: 1. flame control connected to the power supply: the fan output must be without voltage. 2. Disconnect the power supply. Disconnect the fan. The resistive connection between the fan output and the neutral wire is not allowed. If one of the 2 tests fails, replace the flame control because the contacts are definitively joined together and it is no longer possible to guarantee safety.
98	#	Relay supervision error	
	2 - Safety valve 3 Ignition transformer 4 Fuel valve 1 5 Fuel valve 2 6 Fuel valve 3	The relay does not start up	Carry out a reset; if the error arises repeatedly, replace the unit
99	#	Relay internal checking error	Carry out a reset; if the error arises repeatedly, replace the flame control
	3	Relay internal checking error	Carry out a reset; if the error arises repeatedly, replace the flame control Software version V03.10: If error C:99 D:3 occurs during the standardisation of the VSD, temporarily deactivate the Alarm function at the start of the pre-purging phase (parameter 210 = 0) or interrupt the signal controller-ON
100	#	Relay internal checking error	Carry out a reset; if the error arises repeatedly, replace the flame control
105	#	Contact sampling internal error	
	0 Min. pressure switch 1 Max. pressure switch 2 Valve operation test pressure switch 3 Air pressure 4 Load controller open 5 Load controller on/off 6 Load controller closed 7 Safety loop / burner flange 8 Safety valve 9 Ignition transformer 10 Fuel valve 1 11 Fuel valve 2 12 Fuel valve 3 13 Reset	Blocked upon irregularity	Can be caused by capacitive loads or presence of DC voltage on the main power supply of the flame control. The diagnostic code indicates the input in which the problem arose
106 ÷ 108	#	Contact request internal error	Carry out a reset; if the error arises repeatedly, replace the flame control
110	#	Voltage monitoring test internal error	Carry out a reset; if the error arises repeatedly, replace the flame control

Error code	Diagnostic code	Meaning of the REC 27.100A2 system	Recommended measures
111	0	Low level of power supply	Insufficient mains voltage. Conversion of the diagnostic code Voltage value (230 V AC : 1,683)
112	0	Reset power supply voltage	Error code for the carrying out of a reset in the event of power supply restoration (absence of error)
113	#	Mains voltage supervision internal error	Carry out a reset; if the error arises repeatedly, replace the flame control
115	#	Flame control meter internal error	
116	0	Life cycle of the flame control in the critical interval (250,000 Start ups)	The envisaged life cycle of the flame control has been exceeded. Replace it.
117	0	Life cycle of the flame control exceeded	The switch-off threshold has been reached.
120	0	Interruption of fuel limiting meter input	Too many disturbance impulses on the input of the fuel meter. Improve the electromagnetic compatibility.
121 ÷ 124	#	EEPROM access internal error	Carry out a reset, repeat and check the last setting of the parameters. Restore the group of parameters: if the error arises repeatedly, replace the flame control.
125	#	EEPROM reading access internal error	Carry out a reset, repeat and check the last setting of the parameters. If the error arises repeatedly, replace the flame control.
126	#	EEPROM writing access internal error	Carry out a reset, repeat and check the last setting of the parameters. If the error arises repeatedly, replace the flame control.
127	#	EEPROM access internal error	Carry out a reset, repeat and check the last setting of the parameters. Restore the group of parameters: if the error arises repeatedly, replace the flame control.
128	0	EEPROM access internal error - synchronisation during the initialisation	Perform a reset; if the error arises repeatedly, replace the flame control.
129	#	EEPROM access internal error – command synchronisation	Carry out a reset, repeat and check the last setting of the parameters. If the error arises repeatedly, replace the flame control.
130	#	EEPROM access internal error - time-out	Carry out a reset, repeat and check the last setting of the parameters. If the error arises repeatedly, replace the flame control.
131	#	EEPROM access internal error - page interrupted	Carry out a reset, repeat and check the last setting of the parameters. If the error arises repeatedly, replace the flame control.
132	#	EEPROM register initialisation internal error	Perform a reset; if the error arises repeatedly, replace the flame control.
133 ÷ 135	#	EEPROM access internal error – request synchronisation	Carry out a reset, repeat and check the last setting of the parameters. If the error arises repeatedly, replace the flame control.
136	1	Restoration started	The restoration of a backup has been started (no error)
137	#	Internal error – backup / restoration	
	157 (-99)	Restoration – OK, but backup < compared with set data of current system	Restoration successful, but the backup data installed are fewer than those currently present in the system.
	239 (-17)	Backup - logging of the backup on RDI21... failed	Perform the reset and repeat backup
	240 (-16)	Reset - no backup in RDI21...	No backup in RDI21...
	241 (-15)	Reset - Interruptions relating to impracticable ASN	The backup has an impracticable ASN and cannot reset the unit
	242 (-14)	Backup – the backup carried out is contradictory	The backup is irregular and cannot be transferred again
	243 (-13)	Backup – the data comparison between the internal microprocessors is irregular	Repeat the reset and backup
	244 (-12)	The backup data are incompatible	The backup data are incompatible with the current version of the software; the restoration is not possible
	245 (-11)	Error in access to the parameter Restore_Complete	Repeat the reset and backup
	246 (-10)	Restoration – time-out during logging in EEPROM	Repeat the reset and backup
	247 (-9)	The data received are contradictory	The series of backup data is not valid; restoration is not possible
	248 (-8)	The restoration cannot currently be carried out	Repeat the reset and backup
	249 (-7)	Restoration – interruption caused by inadequate identification of the burner	The backup has an inadequate identification of the burner and must not be transferred to the flame control
	250 (-6)	Backup – the CRC of a page is not correct	The series of backup data is not valid; restoration is not possible
	251 (-5)	Backup – the identification of the burner is not defined	Define the identification of the burner and repeat the backup
	252 (-4)	After restoration, the pages are still in INTERRUPTION	Repeat the reset and backup
	253 (-3)	The restoration cannot currently be carried out	Repeat the reset and backup

Error code	Diagnostic code	Meaning of the REC 27.100A2 system	Recommended measures
	254 (-2)	Interruption owing to transmission error	Repeat the reset and backup
	255 (-1)	Interruption owing to time-out during the restoration	Carry out a reset, check the connections and repeat the backup
146	#	Time-out of the system automation interface	Refer to the Modbus User Documentation (A7541)
	1	Modbus time-out	
150	#	TÜV test	
	1 (-1)	Invalid phase	The TÜV test can only be started in phase 60 (operation)
	2 (-2)	The TÜV test default output is too low	The output of the TÜV test must be lower than the minor output limit
	3 (-3)	The TÜV test default output is too high	The output of the TÜV test must be greater than the upper output limit
	4 (-4)	Manual interruption	No error: Manual interruption of the TÜV test by the user
	5 (-5)	TÜV test time-out	No flame loss after the fuel valves have been closed 1. Check for potential extraneous lights 2. Check that there are no short-circuits 3. Check that one of the valves is leaking
165	#	Internal error	
166	0	Watchdog reset internal error	
167	#	Manual lockout	The flame control has been manually blocked (no error)
	1	Manual lockout from remote reset command	
	2	Manual lockout from RDI21...	
	3	Manual lockout from PC interface	
	8	Manual lockout from RDI21... Time-out/interrupted communication	During a regulation of the curve via the operating panel RDI21...the time-out for the operating menu is passed (setting via the 127 parameter), or the communication between REC 27.100A2... and RDI21 has been interrupted
	9	Manual lockout from PC interface Communication interrupted	During an adjustment of the curve via the PC interface, the communication between REC 27.100A2 and the operating panel has been interrupted for more than 30 s
	33	Manual lockout after the PC tool has performed a tentative reset	The PC tool has performed a tentative reset, even if the system has worked correctly
168 ÷ 171	#	Internal error management	Carry out a reset; if the error arises repeatedly, replace the flame control
200 off	#	System free of errors	No error
201 off VA	#	Lockout or error at start	Lockout or error due to lack of unit parameter settings
	Bit 0 Valency 1	No valid operation mode	
	Bit 1 Valency 2..3	No fuel train defined	
	Bit 2 Valency 4..7	No curve defined	
	Bit 3 Valency 8..15	Standardisation speed not defined	
	Bit 4 Valency 16..31	Backup / Reset impossible	
202	#	Selection of internal operation mode	Redefine the operation mode (parameter 201)
203	#	Internal error	Redefine the operation mode (parameter 201) Carry out a reset; if the error arises repeatedly, replace the flame control
204	Phase number	Program stop	The program stop is active (no error)
205	#	Internal error	Carry out a reset; if the error arises repeatedly, replace the flame control
206	0	Combination of flame control and operator panel not allowed	
207	#	Compatibility of flame control with operator panel	
	0	Obsolete version of flame control	
	1	Obsolete version of operator panel	
208 - 209	#	Internal error	Carry out a reset; if the error arises repeatedly, replace the flame control
210	0	The selected operating mode is not released for the standard unit	Select an operating mode released for the standard unit
240	#	Internal error	Carry out a reset; if the error arises repeatedly, replace the flame control

Error code	Diagnostic code	Meaning of the REC 27.100A2 system	Recommended measures
245	#	Internal error	Carry out a reset; if the error arises repeatedly, replace the flame control
250	#	Internal error	Carry out a reset; if the error arises repeatedly, replace the flame control

Tab. S

A Appendix - Accessories**Kit for modulating operation**

Burner	Output regulator	Code
All models	RWF 50.2 3-POINT OUTLET	20085417
All models	RWF 55.5 COMPLETE WITH RS-485 INTERFACE	20074441
All models	RWF 55.6 COMPLETE WITH RS-485/PROFIBUS INTERFACE	20074442

Burner	Probe	Adjustment field	Code
All models	PT 100 temperature	- 100...+ 500°C	3010110
All models	4 - 20 mA pressure	0...2.5 bar	3010213
All models	4 - 20 mA pressure	0...16 bar	3010214

UV sensor kit

Burner	Code
All models	20077814

Soundproofing box kit

Burner	Type	dB(A)	Code
All models	C7	10	3010376

Continuous purging kit

Burner	Code
All models	20077810

Software interface kit (ACS410 + OCI410.30) - Service Level

Burner	Code
All models	3010436

Modbus interface kit

Burner	Model	Code
All models	OCI412	3010437

PVP kit (Seal control function - See gas train booklet)

Burner	Ramp type	Code
All models	MB - CB	3010344

Gas trains in compliance with EN 676

Please refer to manual.

B Appendix - Electrical panel layout

1	Index of layouts
2	Indication of references
3	Layout of unifilar output
4	Layout of unifilar output
5	REC 27.../REC 37... operational layout
6	REC 27.../REC 37... operational layout
7	REC 27.../REC 37... operational layout
8	Electrical connections for power regulator (internal)
9	Electrical connections set by installer
10	Electrical connections set by installer
11	Inputs/outputs power regulator

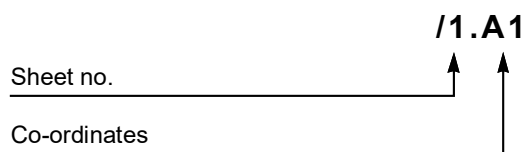
2 Indication of references

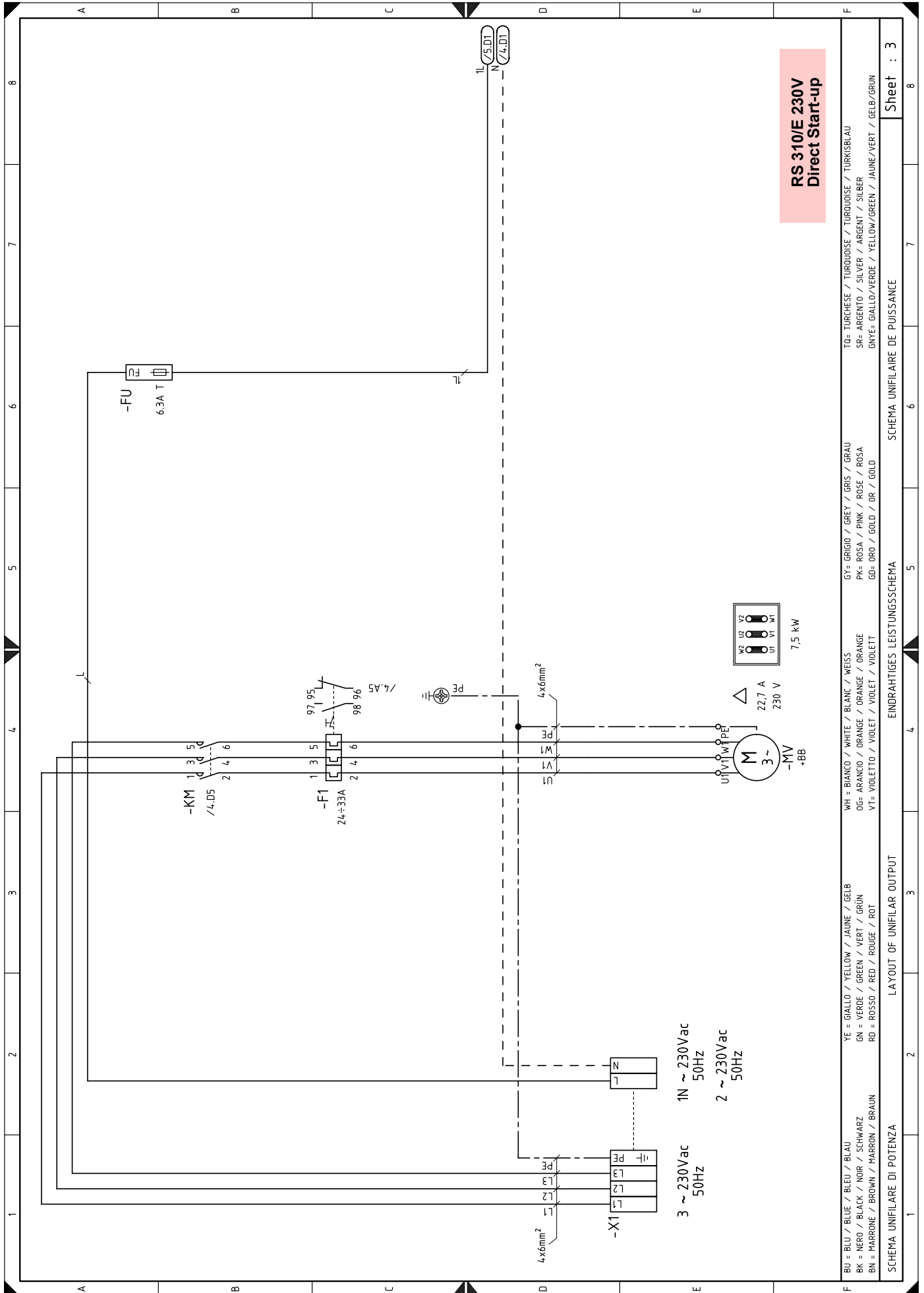

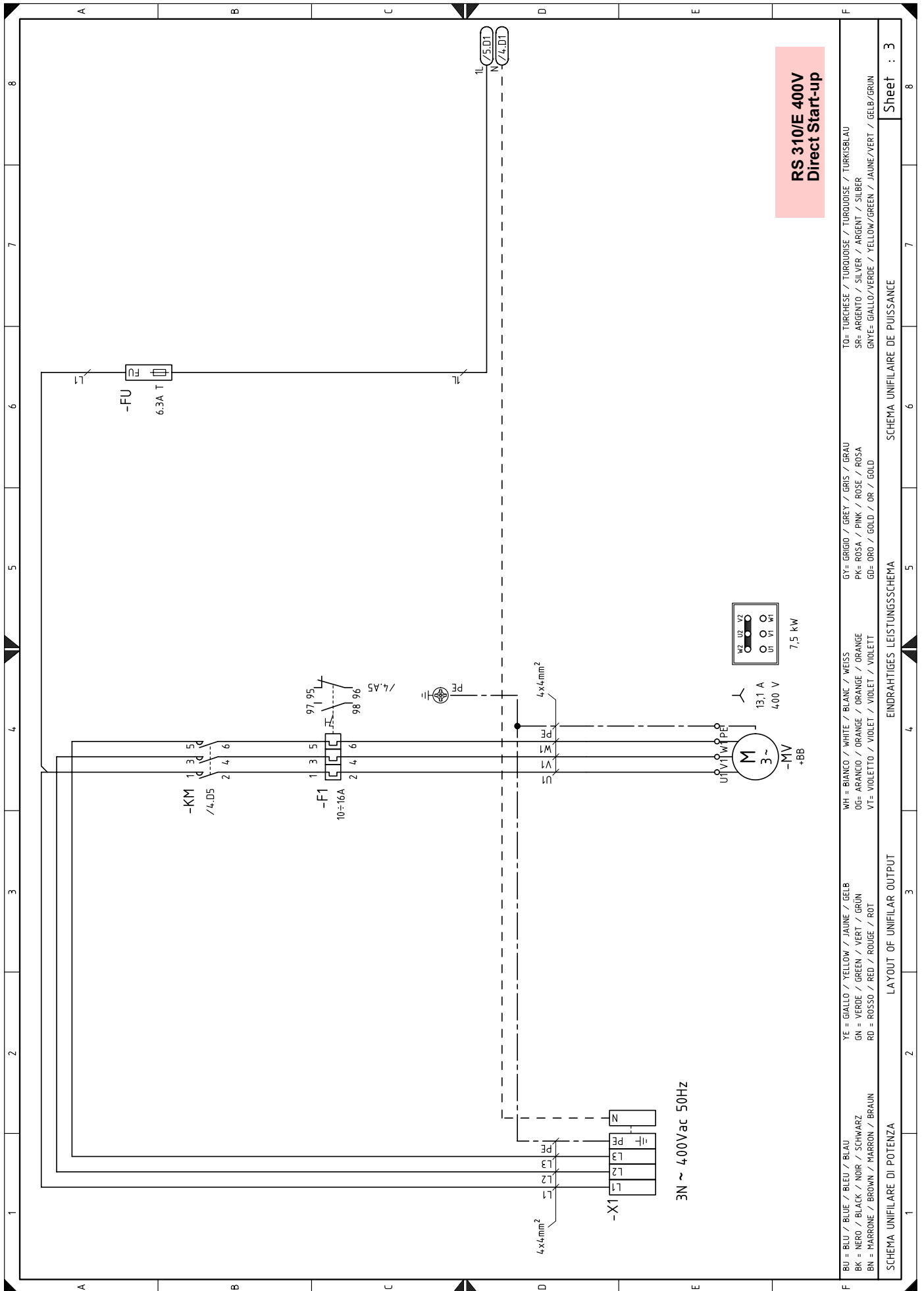

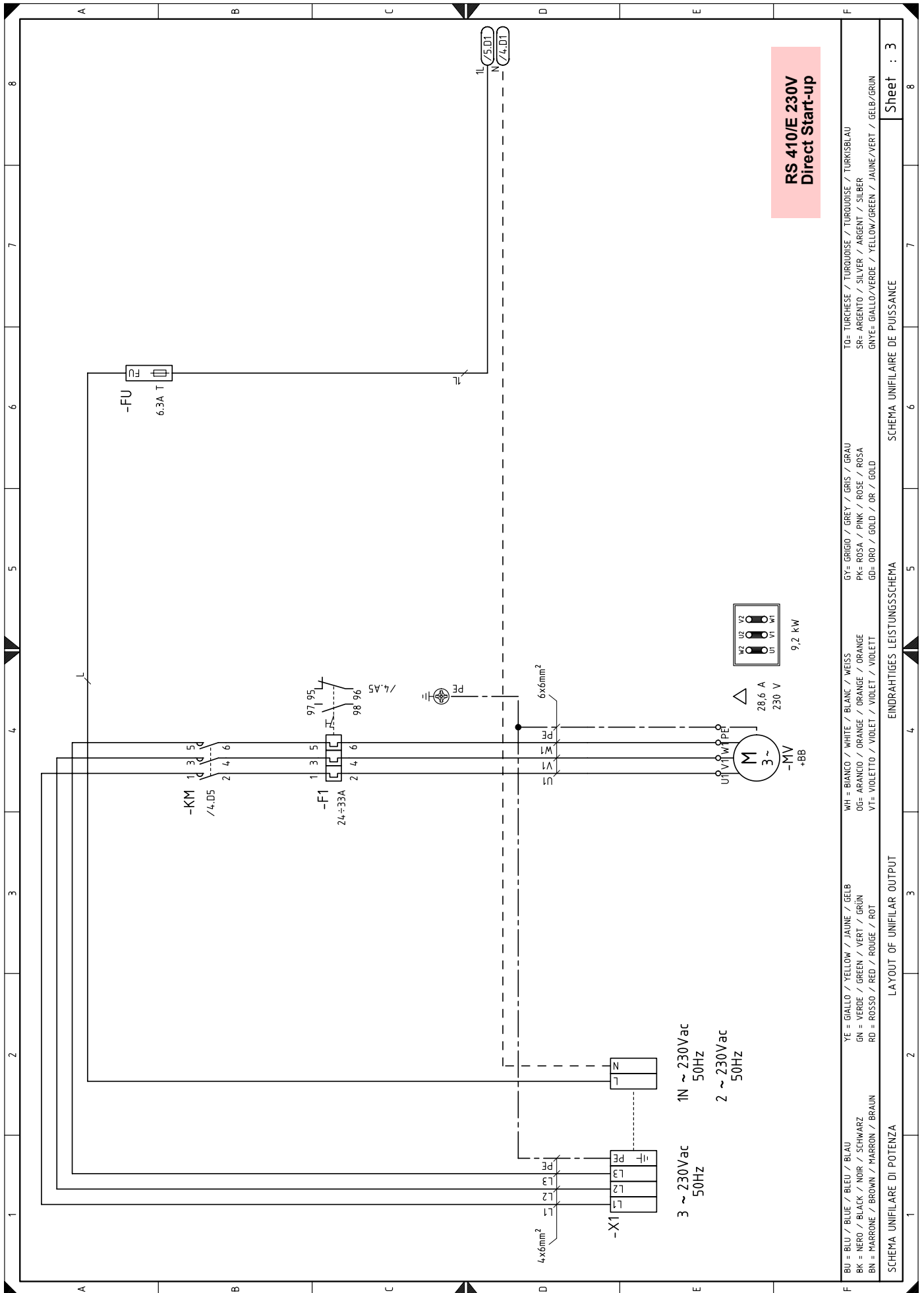

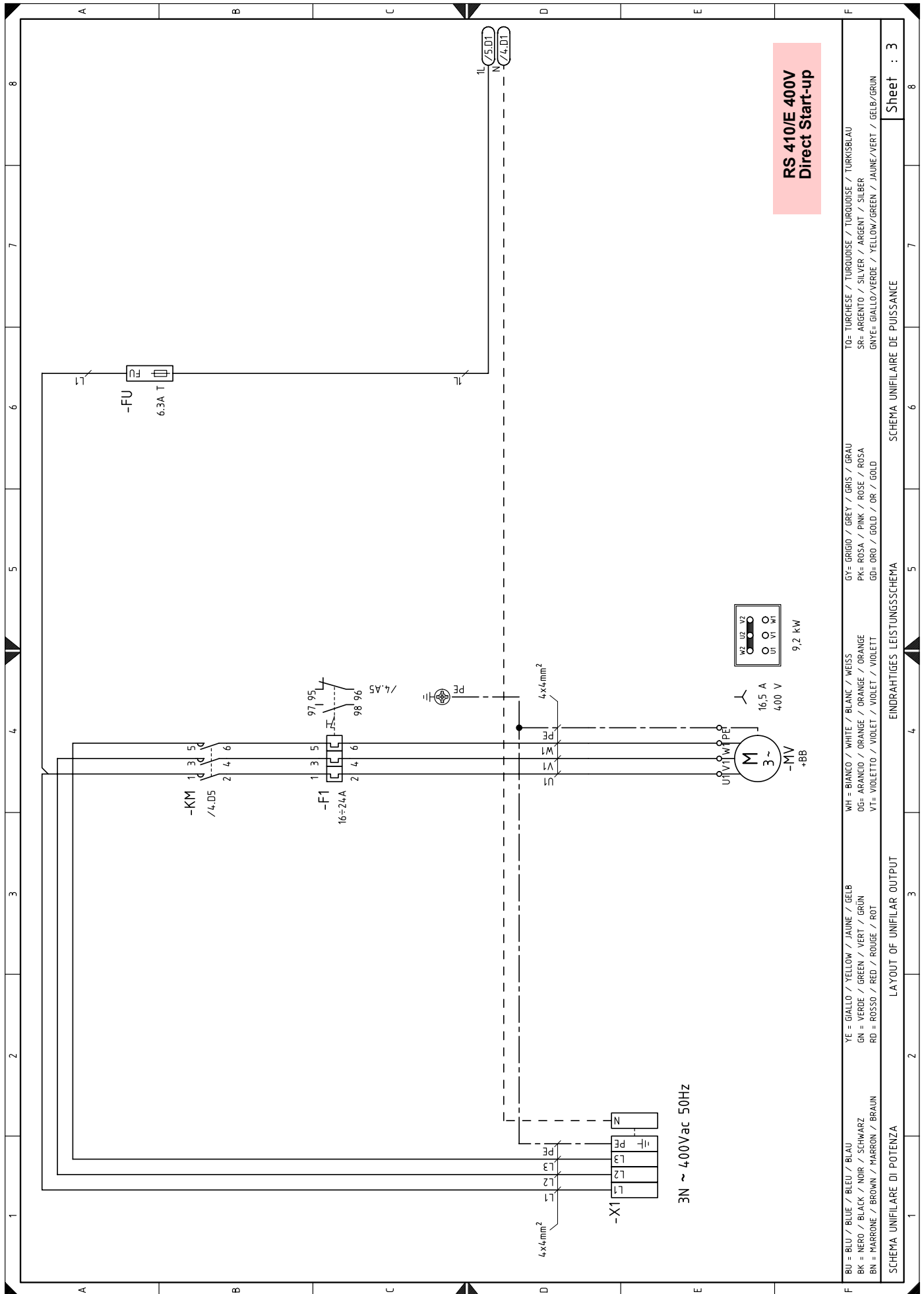

BU = BLU / BLUE / BLEU / BLAU	YE = GIALLO / YELLOW / JAUNE / GELB	WH = BIANCO / WHITE / BLANC / WEISS	GY = GRIGIO / GREY / GRIS / GRAU	TO = TURCHESE / TURKHOISE / TURKHOISE / TURKISBLAU
BK = NERO / BLACK / NOIR / SCHWARZ	GN = VERDE / GREEN / VERT / GRÜN	OG = ARANCIO / ORANGE / ORANGE / ORANGE	PK = ROSA / PINK / ROSE / ROSA	SR = ARGENTO / SILVER / ARGENT / SILBER
BN = MARRONE / BROWN / MARRON / BRAUN	RD = ROSSO / RED / ROUGE / ROT	VT = VIOLETTO / VIOLET / VIOLETT	GD = ORO / GOLD / OR / GOLD	GNYE = GIALLO/VERDE / YELLOW/GREEN / JAUNE/VERT / GELB/GRÜN

SCHEMA UNIFILARE DI POTENZA LAYOUT OF UNIFILAR OUTPUT EINDRAHTIGES LEISTUNGSSCHEMA SCHEMA UNIFILAIRE DE PUISSANCE Sheet : 3

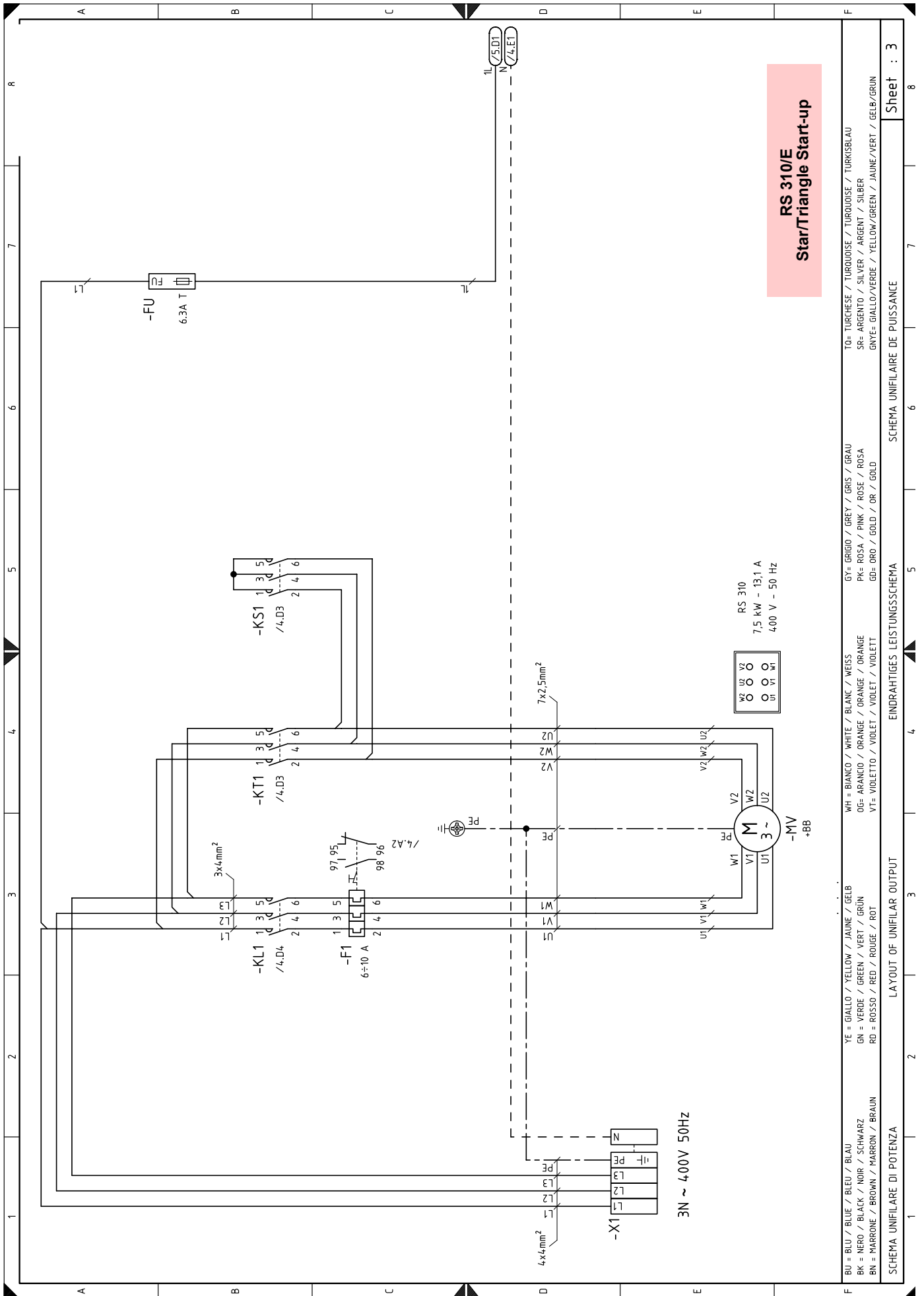

BU = BLU / BLUE / BLEU / BLAU
BK = NERO / BLACK / NOIR / SCHWARZ
BN = MARRONE / BROWN / MARRON / BRAUN
YE = GIALLO / YELLOW / JAUNE / GELB
GN = VERDE / GREEN / VERT / GRÜN
RD = ROSSO / RED / ROUGE / ROT
WH = BIANCO / WHITE / BLANC / WEISS
OG= ARANCIO / ORANGE / ORANGE
VT= VIOLETT / VIOLET / VIOLET / VIOLETT
GY= GRIGIO / GREY / GRIS / GRAU
PK= ROSA / PINK / ROSE / ROSA
GD= ORO / GOLD / OR / GOLD
SR= ARGENTO / SILVER / ARGENT / SILBER
GNYE= GIALLO/VERDE / YELLOW/GREEN / JAUNE/VERT / GELB/GRÜN
T0= TURCHESE / TURKUISE / TURKUISE / TURKUISBLAU

Sheet : 3

SCHEMA UNIFILARE DE PUISSANCE

EINDRAHTIGES LEISTUNGSSCHEMA

LAYOUT OF UNIFILAR OUTPUT

SCHEMA UNIFILARE DI POTENZA

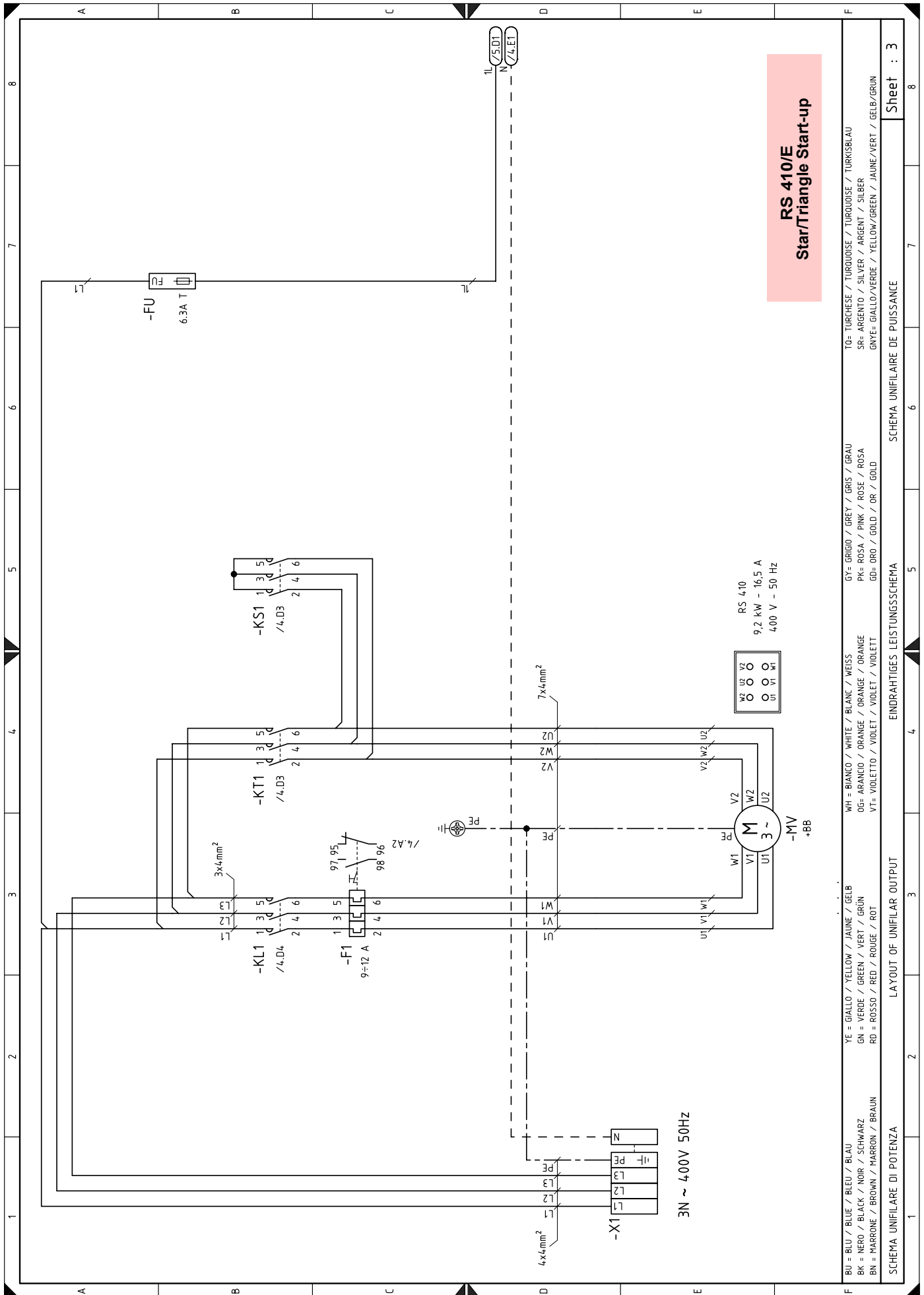

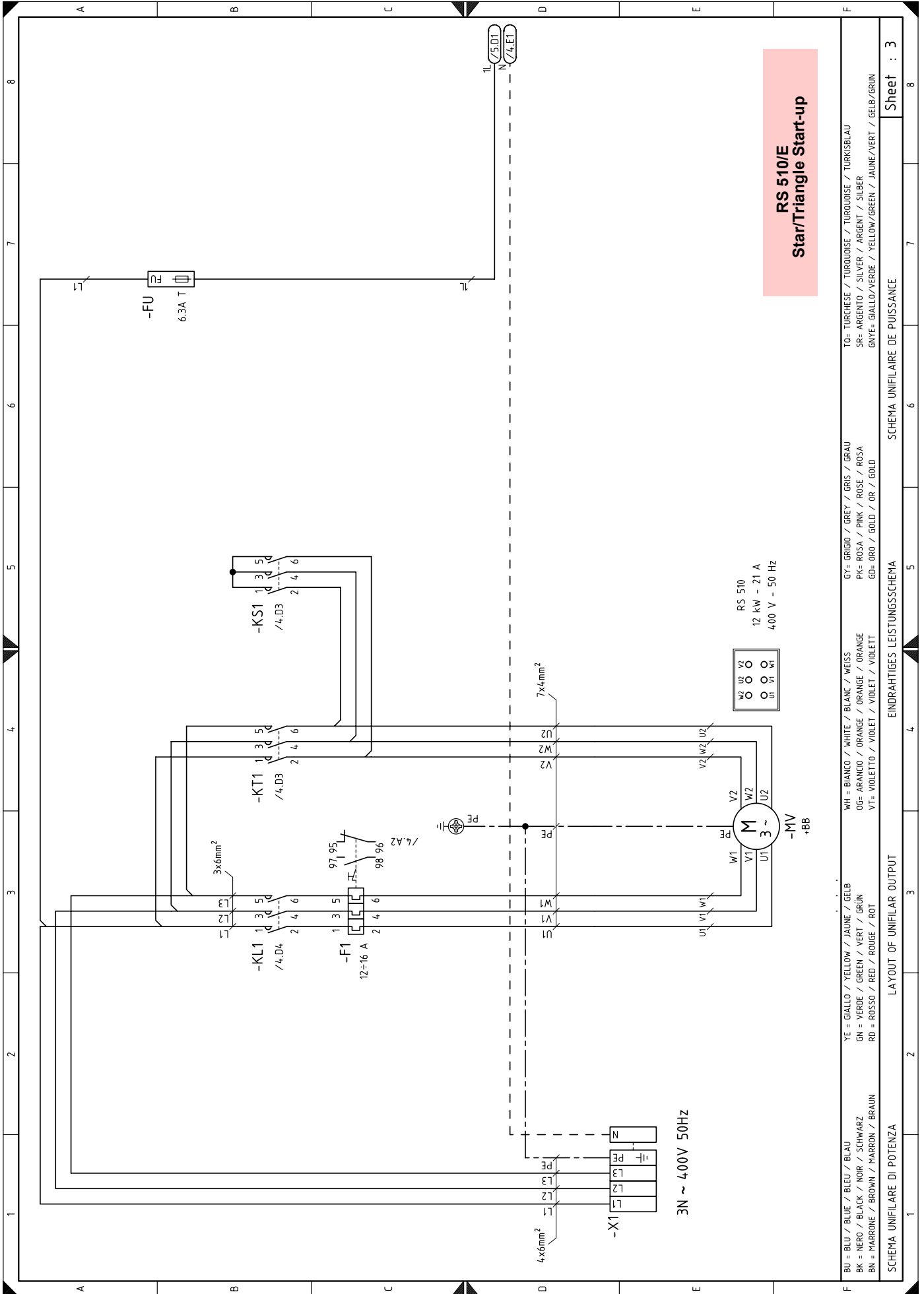

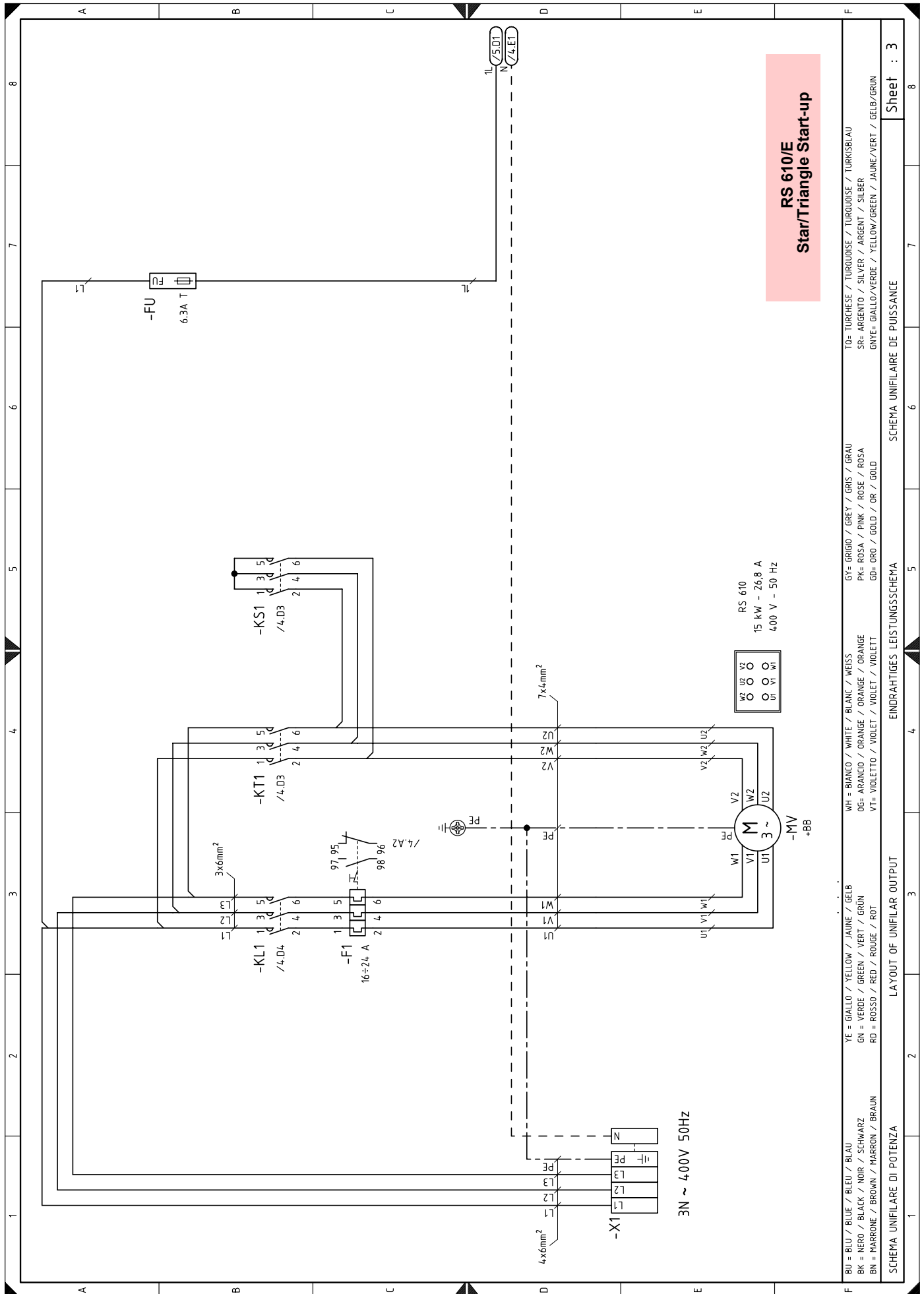

BU = BLU / BLUE / BLEU / BLAU	YE = GIALLO / YELLOW / JAUNE / GELB	WH = BIANCO / WHITE / BLANC / WEISS	GY = GRIGIO / GREY / GRIS / GRAU	TO = TURCHESE / TURQUOISE / TURKOISE / TURKISBLAU
BK = NERO / BLACK / NOIR / SCHWARZ	GN = VERDE / GREEN / VERT / GRÜN	OG = ARANCIO / ORANGE / ORANGE / ORANGE	PK = ROSA / PINK / ROSE / ROSA	SR = ARGENTO / SILVER / ARGENT / SILBER
BN = MARRONE / BROWN / MARRON / BRAUN	RD = ROSSO / RED / ROUGE / ROT	VT = VIOLETTO / VIOLET / VIOLETT	GD = ORO / GOLD / OR / GOLD	GNYE = GIALLO/VERDE / YELLOW/GREEN / JAUNE/VERT / GELB/GRÜN

SCHEMA UNIFILARE DI POTENZA / LAYOUT OF UNIFILAR OUTPUT / EINDRAHTIGES LEISTUNGSSCHEMA / SCHEMA UNIFILAIRE DE PUISSANCE

Sheet : 3

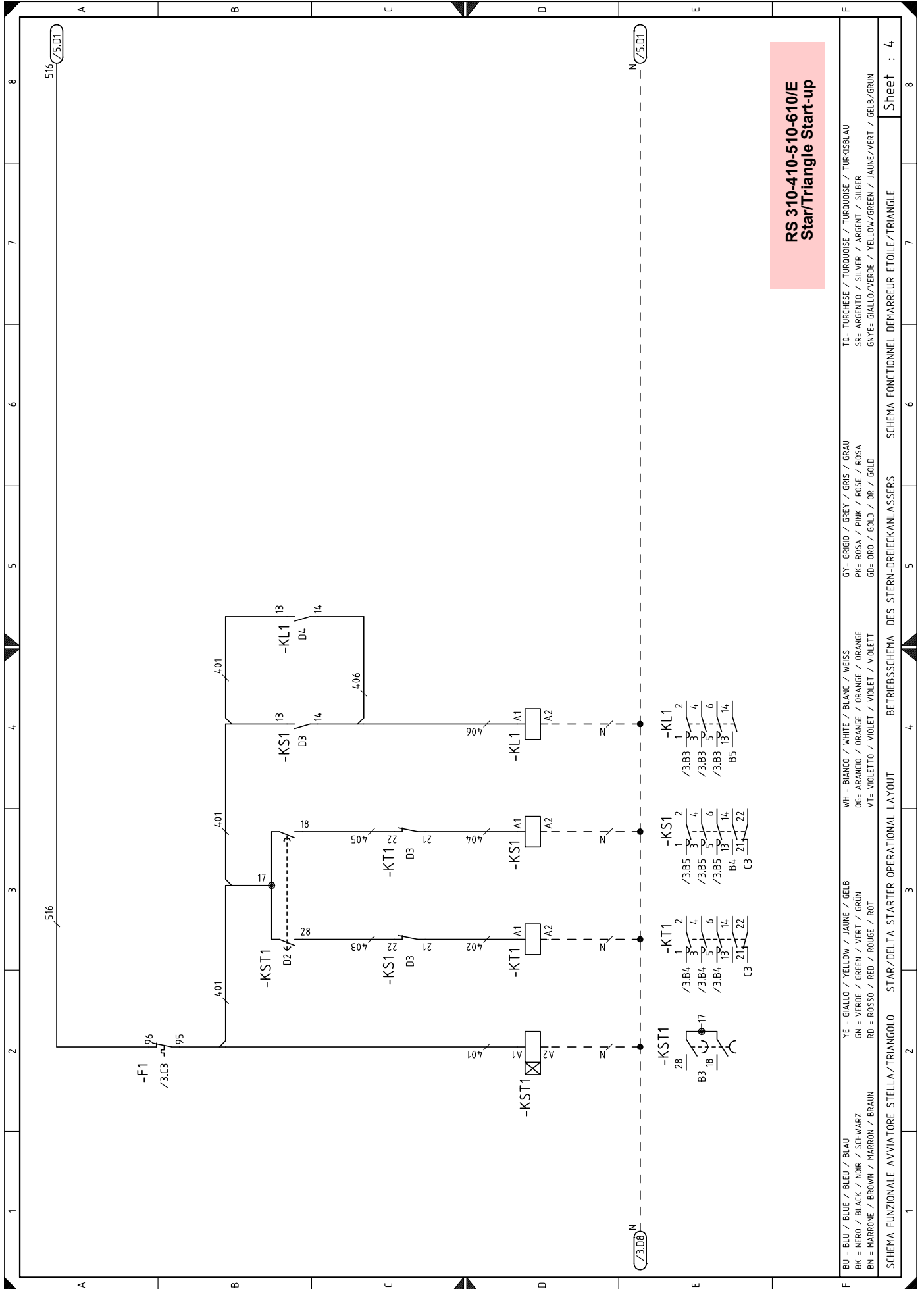

**RS 310-410-510-610/E
Star/Triangle Start-up**

BU = BLU / BLUE / BLEU / BLAU	YE = GIALLO / YELLOW / JAUNE / GELB	WH = BIANCO / WHITE / BLANC / WEISS	GY= GRIGIO / GREY / GRIS / GRAU	TO= TURCHESE / TURQUOISE / TURKOISE / TURKISBLAU			
BK = NERO / BLACK / NOIR / SCHWARZ	GN = VERDE / GREEN / VERT / GRÜN	OG= ARANCIO / ORANGE / ORANGE / ORANGE	PK= ROSA / PINK / ROSE / ROSA	SR= ARGENTO / SILVER / ARGENT / SILBER			
BN = MARRONE / BROWN / MARRON / BRAUN	RD = ROSSO / RED / ROUGE / ROT	VT= VIOLETTA / VIOLET / VIOLET / VIOLETT	GD= ORO / GOLD / OR / GOLD	GNYE= GIALLO/VERDE / YELLOW/GREEN / JAUNE/VERT / GELB/GRÜN			
SCHEMA FUNZIONALE AVVIATORE STELLA/TRIANGOLO			SCHEMA FONCTIONNEL DEMARREUR ETOILE/TRIANGLE				
STAR/DELTA STARTER OPERATIONAL LAYOUT			BETRIEBSSCHEMA DES STERN-DREIECKANLASSERS				
1	2	3	4	5	6	7	8
							Sheet : 4

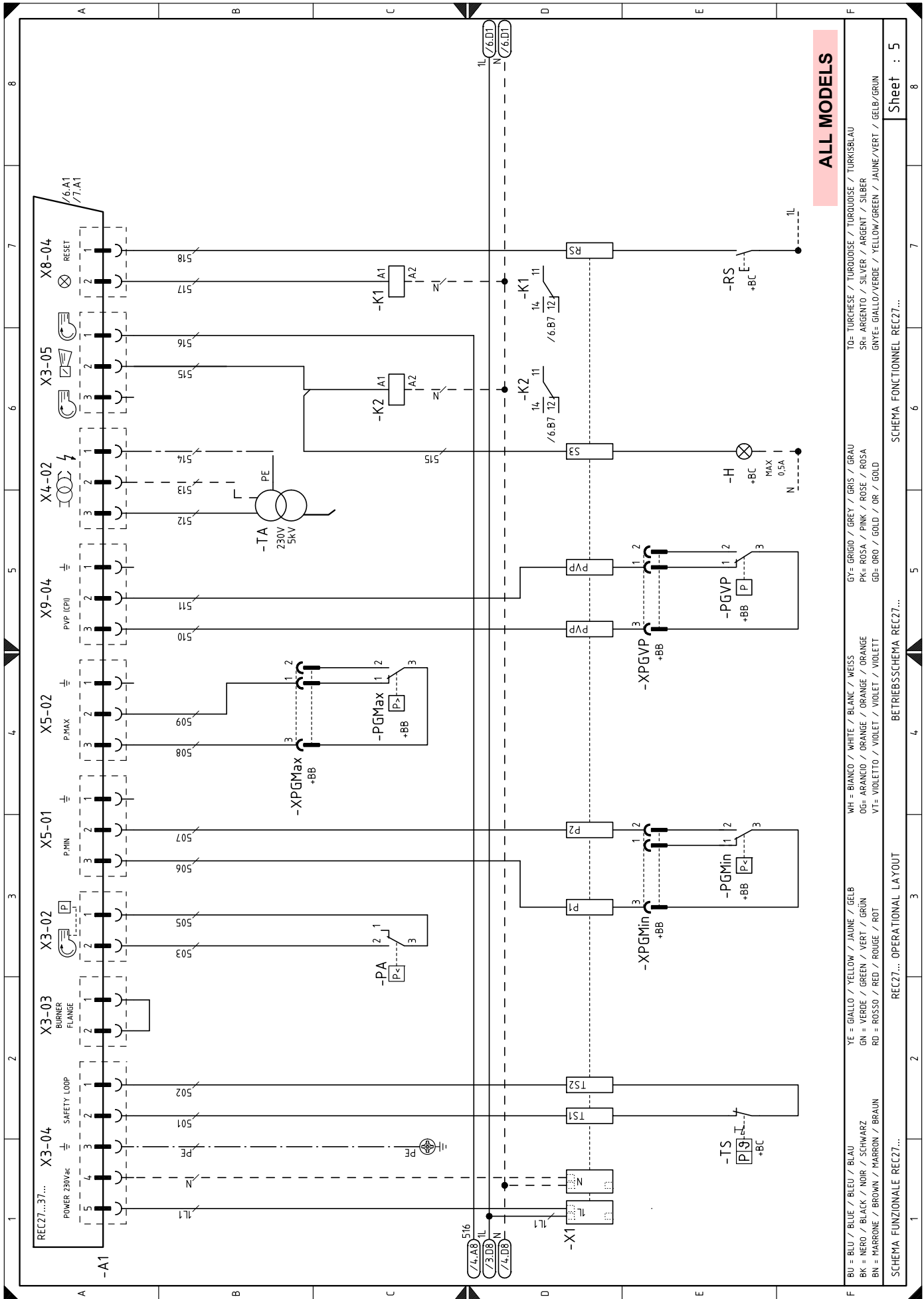

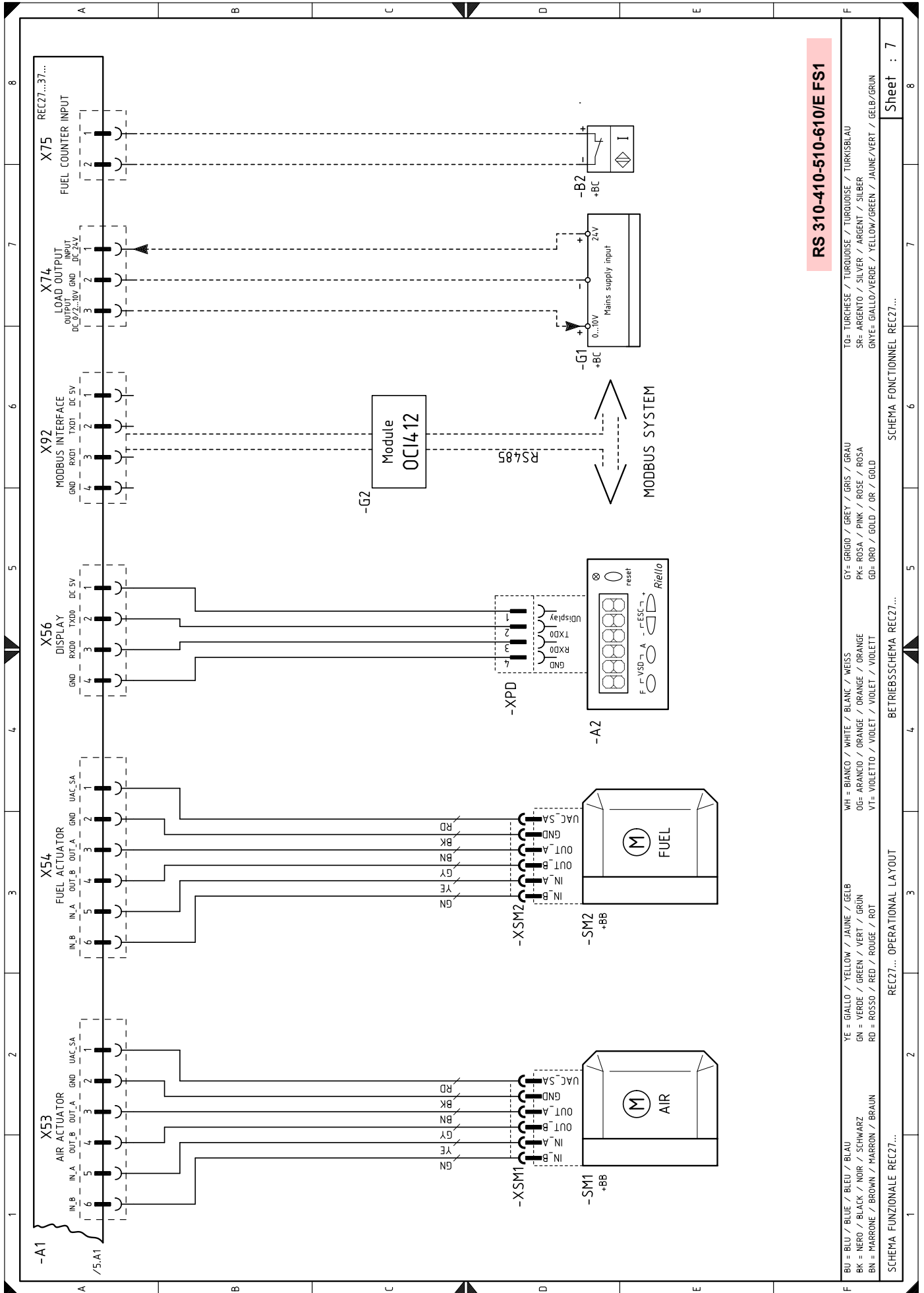

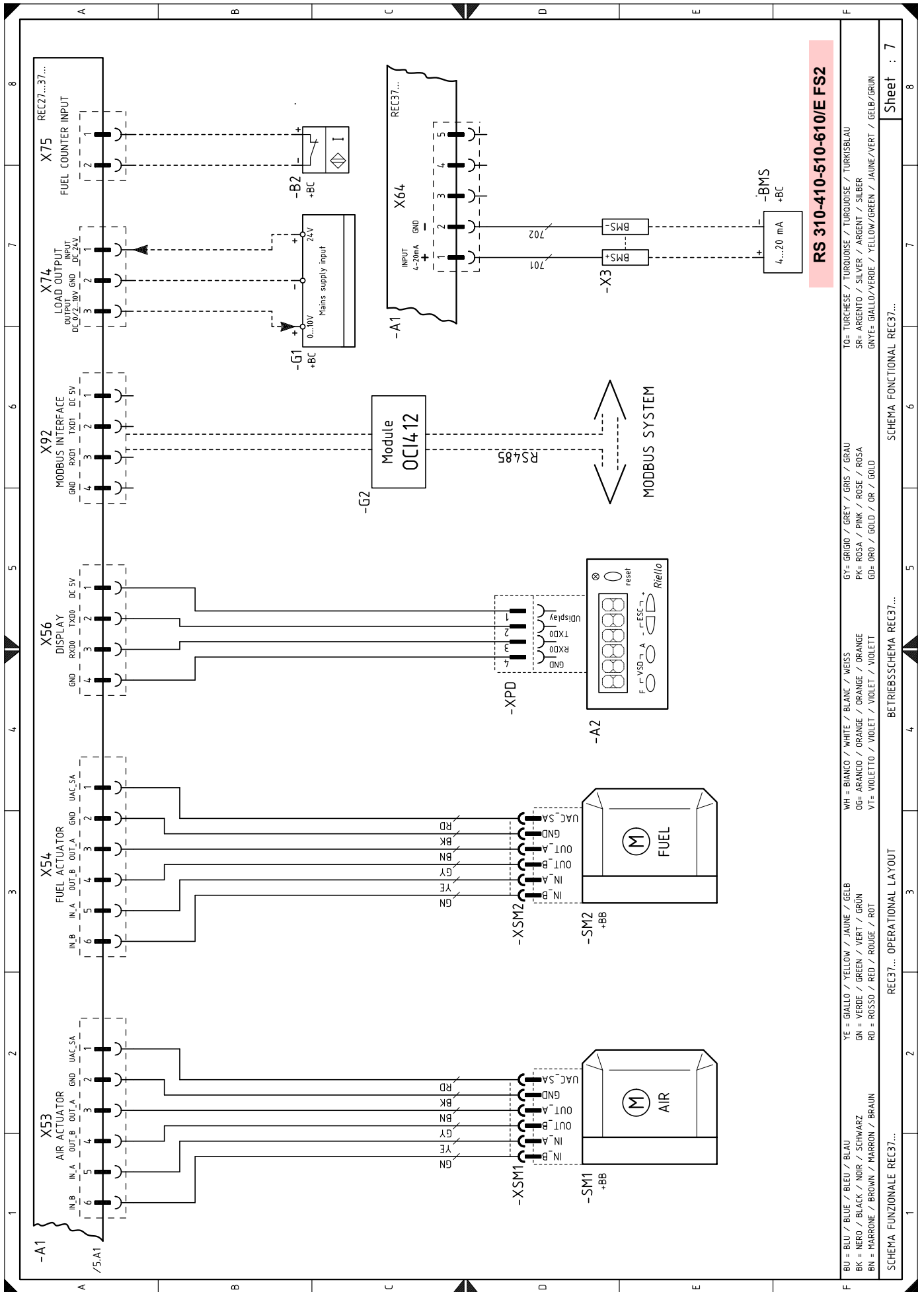

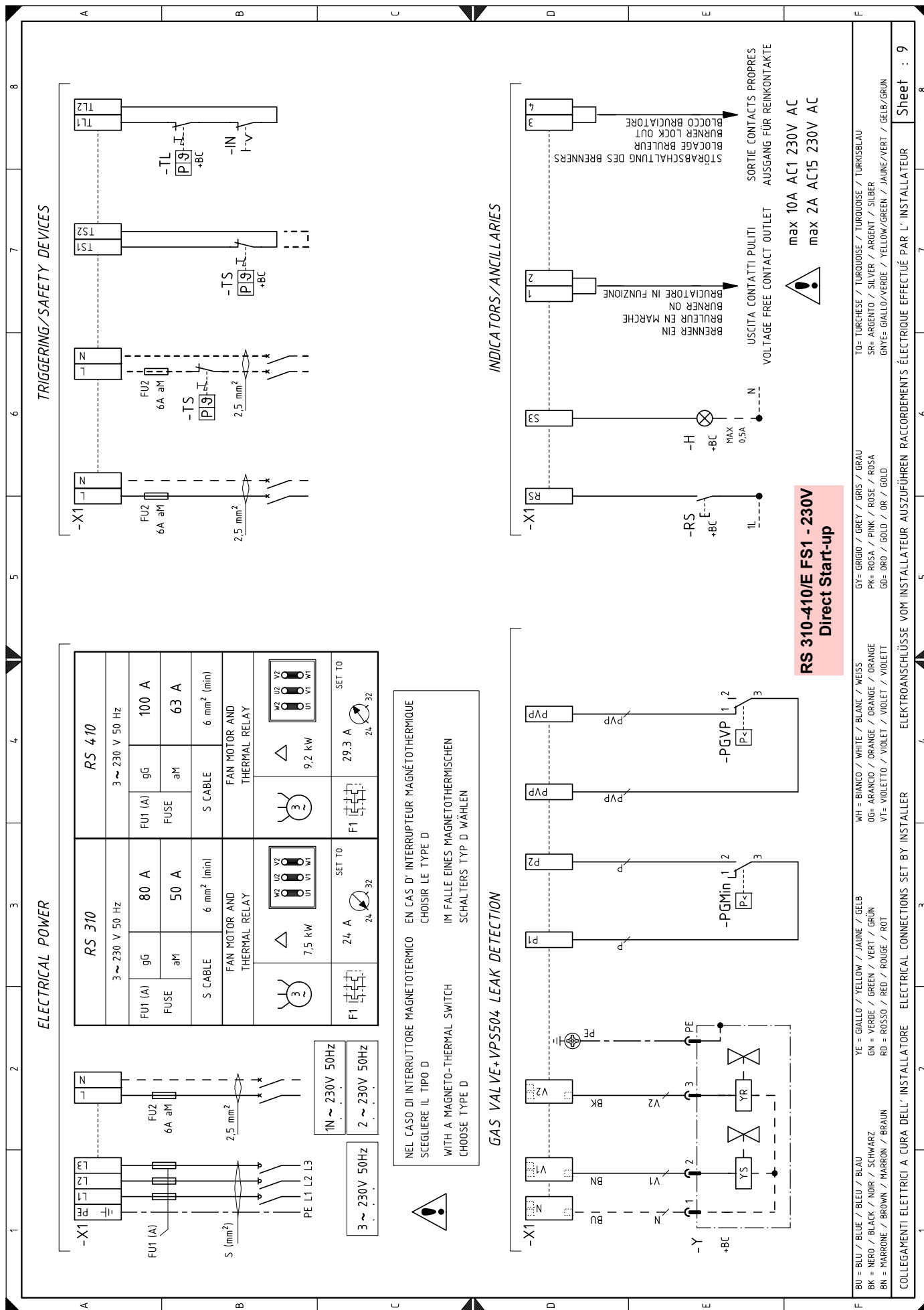

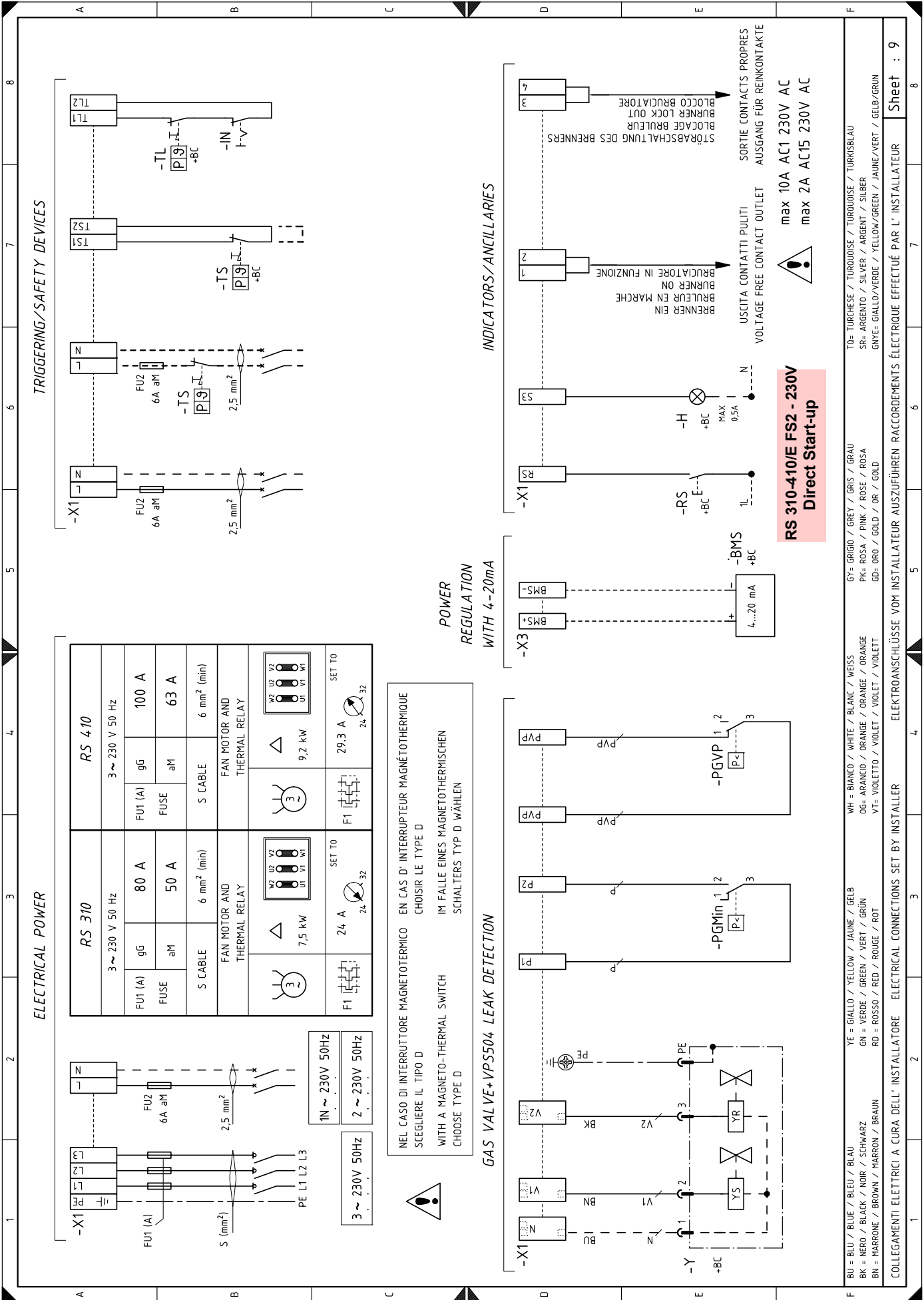

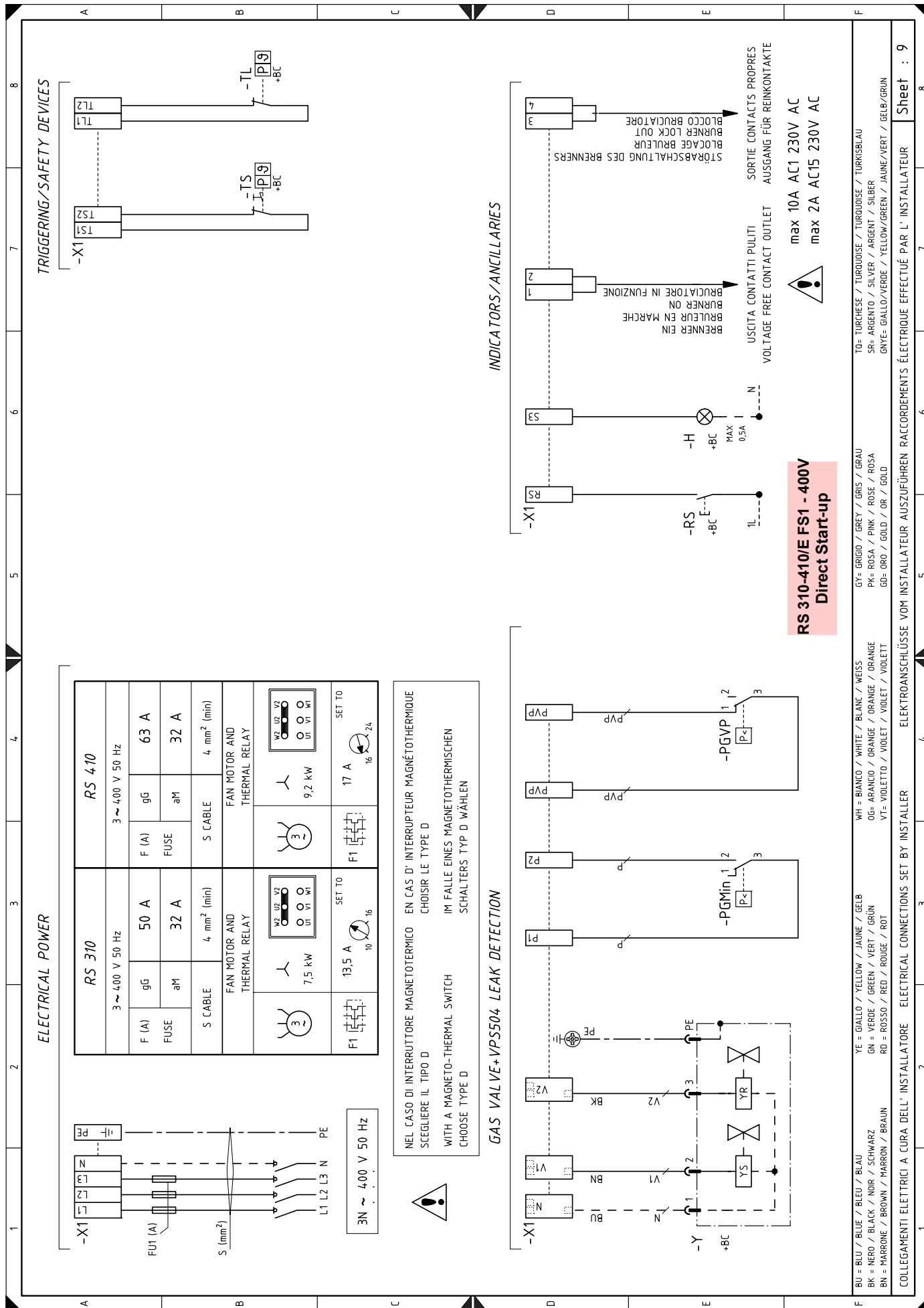

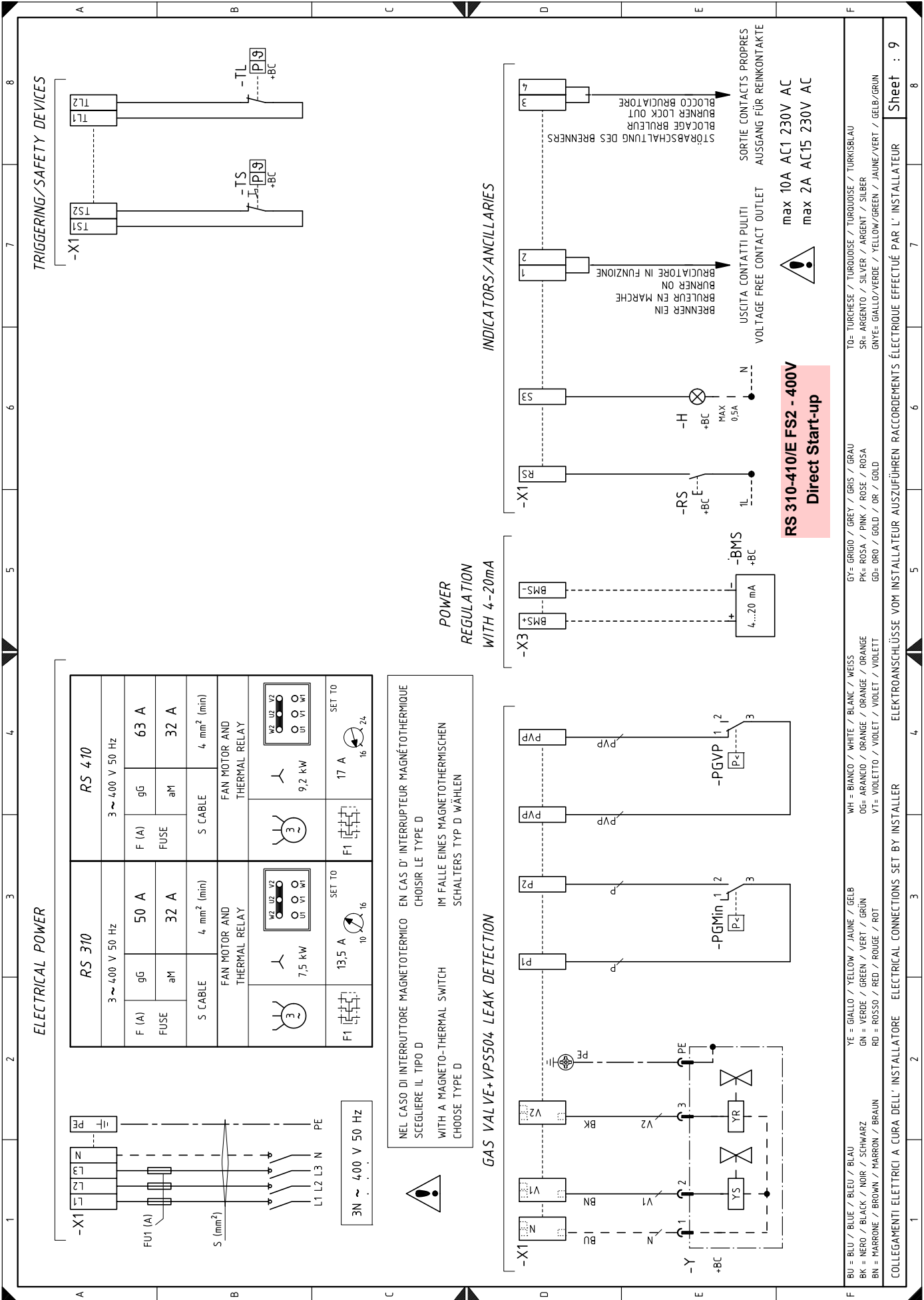

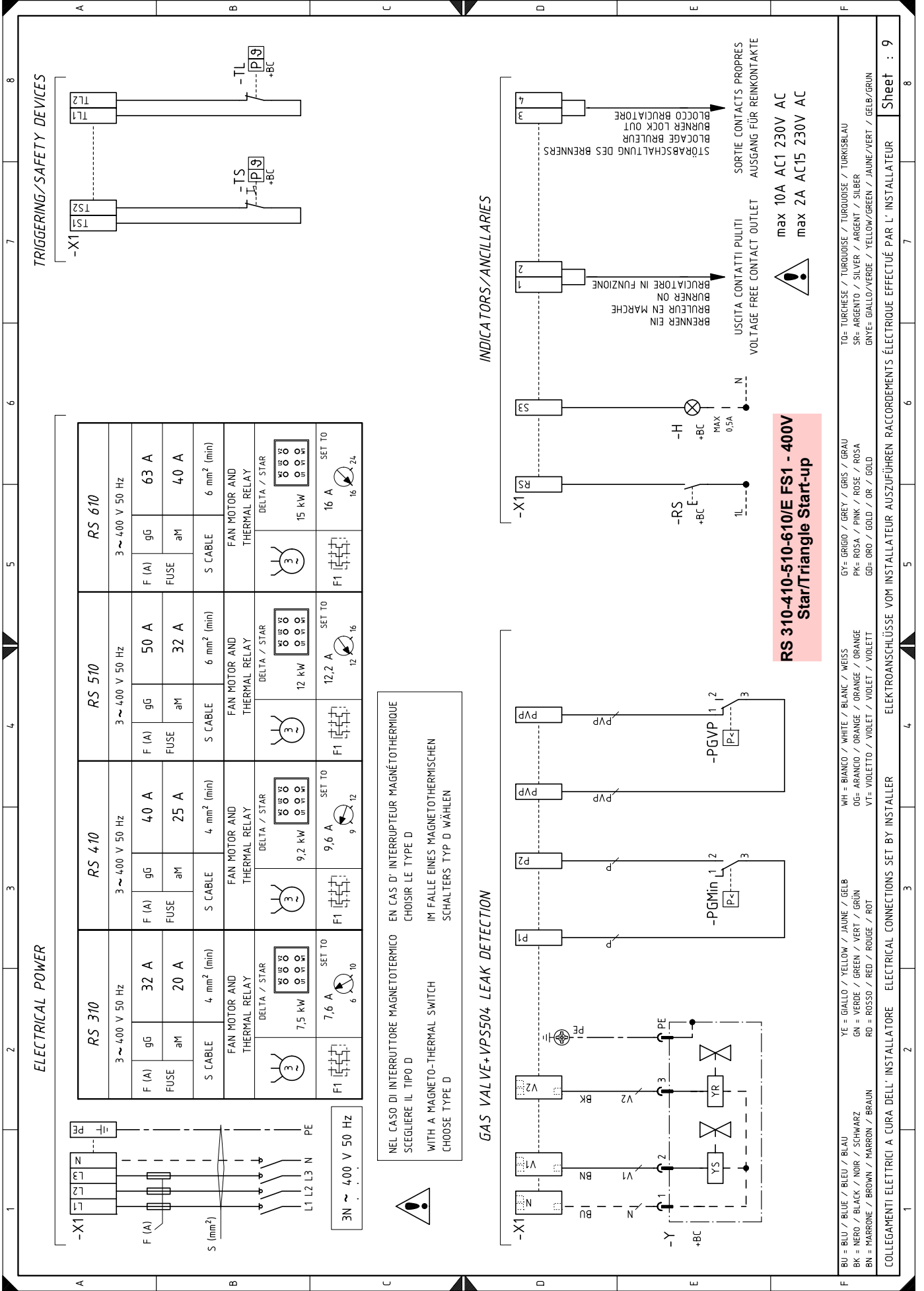

NEL CASO DI INTERRUPTORE MAGNETOTERMICO SCEGLIERE IL TIPO D
WITH A MAGNETO-THERMAL SWITCH CHOOSE TYPE D

EN CAS D'INTERRUPTEUR MAGNÉTO-THERMIQUE CHOISIR LE TYPE D
IM FALLE EINES MAGNETOTHERMISCHEN SCHALTERS TYP D WÄHLEN

- BU = BLU / BLUE / BLEU / BLAU
- BK = NERO / BLACK / NOIR / SCHWARZ
- BN = MARRONE / BROWN / MARRON / BRAUN
- YE = GIALLO / YELLOW / JAUNE / GELB
- GN = VERDE / GREEN / VERT / GRÜN
- RD = ROSSO / RED / ROUGE / ROT
- WH = BIANCO / WHITE / BLANC / WEISS
- OG = ARANCIO / ORANGE / ORANGE / ORANGE
- VT = VIOLETTO / VIOLET / VIOLET / VIOLETT
- GY = GRIGIO / GREY / GRIS / GRAU
- PK = ROSA / PINK / ROSE / ROSA
- GD = ORO / GOLD / OR / GOLD
- TU = TURCHESE / TURBOISE / TURKISBLAU
- SR = ARGENTO / SILVER / ARGENT / SILBER
- GNVE = GIALLO/VERDE / YELLOW/GREEN / JAUNE/VERT / GELB/GRÜN

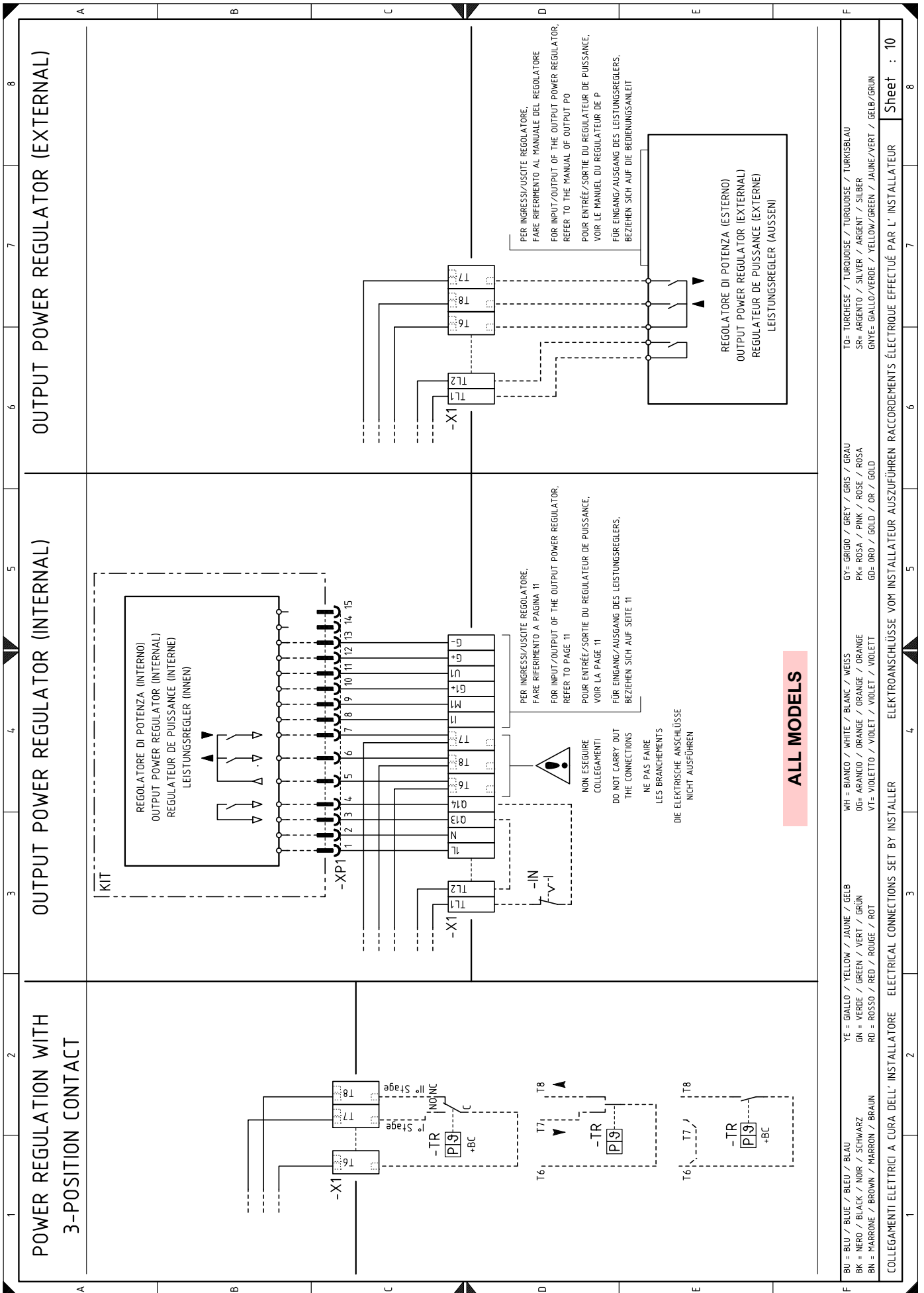

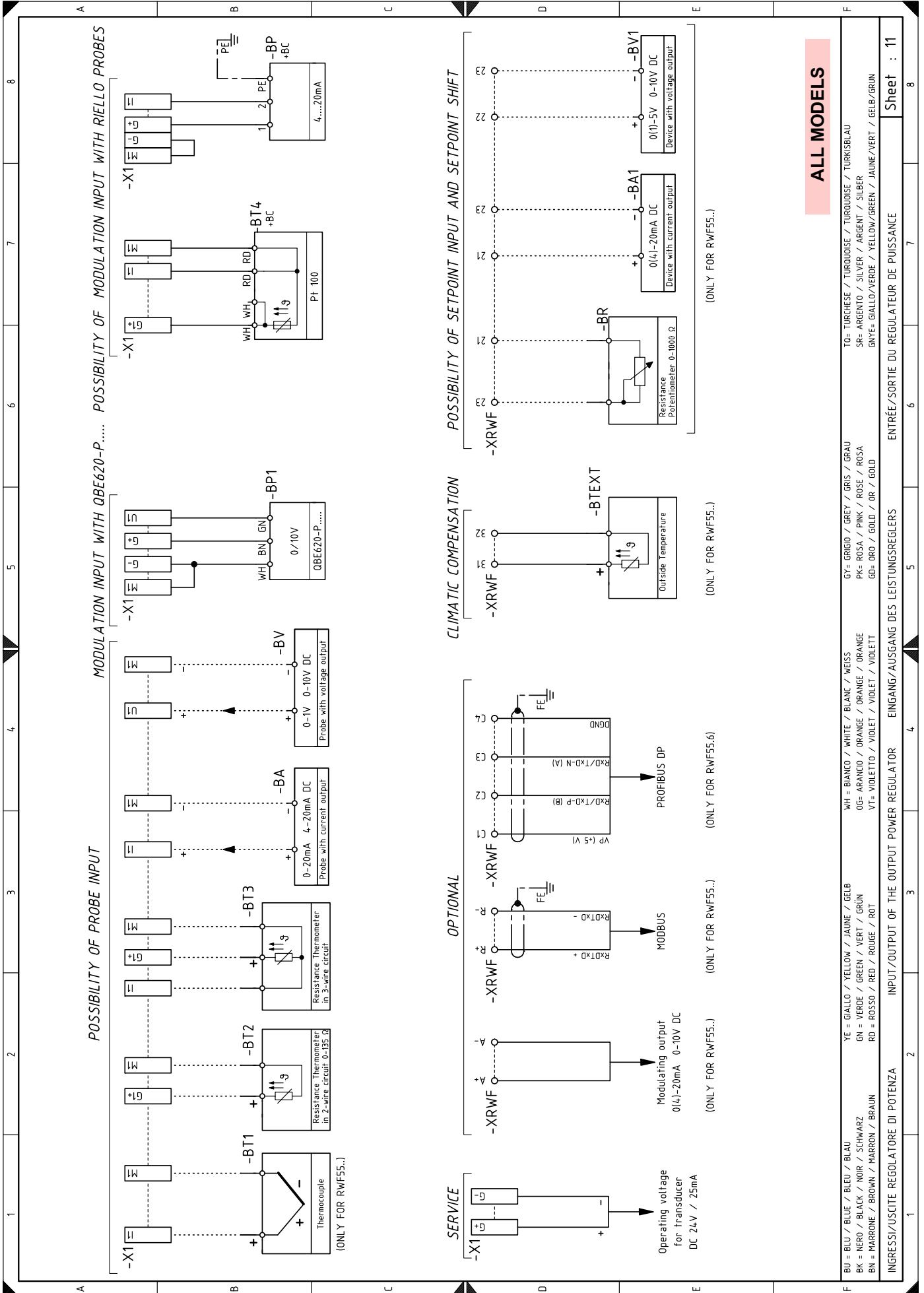

Wiring layout key

A1	Flame control	XPGMax	Maximum gas pressure switch connector
A2	Display and calibration unit	XPGMin	Minimum gas pressure switch connector
B1	Output regulator RWF50 internal	XPGVP	Gas pressure switch connector for valve leak detection control device
B2	Fuel meter		
BA	Probe with output under current	XRWF	Terminal board for output power regulator RWF50
BA1	Device with output under current, for modifying remote setpoint		
BMS	Modulation control 4-20mA		
BP	Pressure probe		
BP1	Pressure probe		
BR	Remote setpoint potentiometer		
BT1	Thermocouple probe		
BT2	Probe Pt100, 2 wires		
BT3	Probe Pt100, 3 wires		
BT4	Probe Pt100, 3 wires		
BTEXT	External probe for climatic compensation of the setpoint		
BV	Output probe in voltage		
BV1	Output device in voltage to modify remote setpoint		
F1	Fan motor thermal relay		
FU	Auxiliary circuits safety fuse		
G1	Load indicator		
G2	Communication interface for Modbus system		
H	Burner working lighting signal output		
IN	Burner manual stop electric switch		
ION	Ionisation probe		
KL1	Star/triangle starter line contactor		
KM	Direct start up contactor		
KT1	Star/triangle starter triangle contactor		
KS1	Start/triangle starter star contactor		
KST1	Star/triangle starter timer		
K1	Clean contacts output relay burner switched on		
K2	Clean contacts output relay burner lockout		
MV	Fan motor		
PA	Air pressure switch		
PE	Burner earth		
PGMax	Maximum gas pressure switch		
PGMin	Minimum gas pressure switch		
PGVP	Gas pressure switch for valve leak detection control device		
RS	Burner reset switch		
S2	ON/OFF selector		
SM1	Air servomotor		
SM2	Gas servomotor		
TA	Ignition transformer		
TL	Limit thermostat/pressure switch		
TR	Adjustment thermostat/pressure switch		
TS	Safety thermostat/pressure switch		
Y	Gas regulator valve + gas safety valve		
X1	Terminal board for main supply		
X3	Terminal board for modulation control 4-20mA		
XPD	Plug for on board display		

RIELLO

RIELLO S.p.A.
I-37045 Legnago (VR)
Tel.: +39.0442.630111
[http:// www.riello.it](http://www.riello.it)
[http:// www.riello.com](http://www.riello.com)