

GB Premix gas burner

Modulating operation



CODE	MODEL
20048843	RX 150 S/PV
CODE	COMBUSTION HEAD ASSEMBLY
20048844	L = 690
20121231	L = 500



Original instructions

1	Information and general warnings	3
1.1	Information about the instruction manual	3
1.1.1	Introduction	3
1.1.2	General dangers	3
1.1.3	Other symbols	3
1.1.4	Delivery of the system and the instruction manual.	4
1.2	Guarantee and responsibility	4
1.2.1	Owner's responsibility	5
2	Safety and prevention	6
2.1	Introduction	6
2.2	Personnel training	6
3	Technical description of the burner	7
3.1	Technical data	7
3.2	Electrical data	7
3.3	Packaging - weight - Approximate measurements	8
3.4	Burner dimensions	8
3.5	Burner description	9
3.6	Burner equipment	9
3.7	Firing rates	10
3.8	Burner controls (LME71...)	11
3.8.1	Indication of diagnostics mode	16
4	Installation	17
4.1	Notes on safety for the installation	17
4.2	Handling	17
4.3	Preliminary checks	18
4.4	Operating position	18
4.5	Preparing the boiler	18
4.5.1	Boring the boiler plate	18
4.5.2	Head length	19
4.6	Probe - electrodes positioning	19
4.7	Installation of combustion head, electrode and probe	20
4.8	Securing the burner to the boiler	21
4.9	Fuel supply	22
4.9.1	Air/gas mixer	22
4.9.2	Gas train	23
4.10	Electrical wiring	24
4.10.1	Supply cables and external connections passage	25
4.10.2	Factory wiring diagram	26
4.10.3	Wiring diagram (customer installation)	27
4.10.4	Opening sequence of the fuse-holder	28
5	Start-up, calibration and operation of the burner	29
5.1	Notes on safety for the first start-up	29
5.2	Adjustments before first firing	29
5.3	Fan adjustment	29
5.4	Burner start-up	29
5.4.1	First burner start-up (manual operation)	29
5.4.2	Checking the modulating operation (automatic operation)	31
5.5	Burner shut down	33
5.6	Gas valve adjustment	33

5.7	Burner adjustment	33
5.7.1	Optimum calibration values	34
5.8	Check of modulating operation	34
5.8.1	Display of preset output	34
5.8.2	Load controller inputs	34
6	Maintenance	35
6.1	Notes on safety for the maintenance	35
6.2	Maintenance programme	35
6.2.1	Maintenance frequency	35
6.2.2	Checking and cleaning	35
6.2.3	Measuring circuit for detector current measurement	36
6.3	Safety components	37
6.4	Recommended preventive maintenance schedule	37
6.5	Opening and closing the burner	38
7	Operation, indication, diagnostics	39
7.1	Control sequence in the event of fault	39
7.2	Fault status messages, display of errors	39
7.2.1	Display of errors (faults) with lockout	39
7.3	Error code list with operation via internal LED	40
7.4	Resetting the burner control	41
7.5	Operation	41
7.5.1	Manual adjustment	41
7.5.2	Diagnostics of cause of fault	43
7.5.3	First startup with a new program module or in case of replacement of program module	44
7.6	Manual restore	45
7.6.1	Errors during the restore process	46
7.6.2	Reset	46
A	Appendix - Spare parts	47
B	Appendix - Accessories	49
C	Appendix - Burner start up report	50

1 Information and general warnings

1.1 Information about the instruction manual

1.1.1 Introduction



WARNING

Read these instructions and save for reference!
These installation and operating instructions form part of the unit and must be kept in good and legible conditions on site at all times.

The instruction manual supplied with the burner:

- is an integral and essential part of the product and must not be separated from it; it must therefore be kept carefully for any necessary consultation and must accompany the burner even if it is transferred to another owner or user, or to another system. If the manual is lost or damaged, another copy must be requested from the Technical Assistance Service of the area;
- is designed for use by qualified personnel;
- offers important indications and instructions relating to the installation safety, start-up, use and maintenance of the burner.

Symbols used in the manual

In some parts of the manual you will see triangular DANGER signs. Pay great attention to these, as they indicate a situation of potential danger.

1.1.2 General dangers

The **dangers** can be of **3 levels**, as indicated below.



DANGER

Maximum danger level!
This symbol indicates operations which, if not carried out correctly, cause serious injury, death or long-term health risks.



WARNING

This symbol indicates operations which, if not carried out correctly, may cause serious injury, death or long-term health risks.



CAUTION

This symbol indicates operations which, if not carried out correctly, may cause damage to the machine and/or injury to people.

1.1.3 Other symbols



DANGER

DANGER: LIVE COMPONENTS
This symbol indicates operations which, if not carried out correctly, lead to electric shocks with lethal consequences.



DANGER: FLAMMABLE MATERIAL
This symbol indicates the presence of flammable materials.



DANGER: BURNING
This symbol indicates the risks of burns due to high temperatures.



DANGER: CRUSHING OF LIMBS

This symbol indicates the presence of moving parts: danger of crushing of limbs.



WARNING: MOVING PARTS

This symbol indicates that you must keep limbs away from moving mechanical parts; danger of crushing.



DANGER: EXPLOSION

This symbol signals places where an explosive atmosphere may be present. An explosive atmosphere is defined as a mixture - under atmospheric conditions - of air and flammable substances in the form of gases, vapours, mist or dust in which, after ignition has occurred, combustion spreads to the entire unburned mixture.



PERSONAL PROTECTION EQUIPMENT

These symbols indicate the equipment that must be worn and kept by the operator for protection against threats against safety and/or health while at work.



OBLIGATION TO ASSEMBLE THE COVER AND ALL THE SAFETY AND PROTECTION DEVICES

This symbol signals the obligation to reassemble the cover and all the safety and protection devices of the burner after any maintenance, cleaning or checking operations.



ENVIRONMENTAL PROTECTION

This symbol gives indications for the use of the machine with respect for the environment.



IMPORTANT INFORMATION

This symbol indicates important information that you must bear in mind.



This symbol indicates a list.

Abbreviations used

Ch.	Chapter
Fig.	Figure
Page	Page
Sec.	Section
Tab.	Table

1.1.4 Delivery of the system and the instruction manual

When the system is delivered, it is important that:

- the instruction manual is delivered to the user by the system manufacturer, with the recommendation to keep it in the room where the heat generator is to be installed.

- The instruction manual shows:

- the serial number of the burner;

.....

- the address and telephone number of the nearest Assistance Centre.

.....

.....

.....

- the date of installation;

.....

- The system supplier must carefully inform the user about:
 - the use of the system;
 - any further tests that may be required before activating the system;
 - maintenance, and the need to have the system checked at least once a year by a representative of the manufacturer or another specialised technician.

To ensure a periodic check, the manufacturer recommends the drawing up of a Maintenance Contract.

1.2 Guarantee and responsibility

The manufacturer guarantees its new products from the date of installation, in accordance with the regulations in force and/or the sales contract. At the moment of the first start-up, check that the burner is integral and complete.



WARNING

Failure to observe the information given in this manual, operating negligence, incorrect installation and carrying out of non authorised modifications will result in the annulment by the manufacturer of the guarantee that it supplies with the burner.

In particular, the rights to the guarantee and the responsibility will no longer be valid, in the event of damage to things or injury to people, if such damage/injury was due to any of the following causes:

- incorrect installation, start-up, use and maintenance of the burner;
- improper, incorrect or unreasonable use of the burner;
- intervention of unqualified personnel;
- carrying out of unauthorised modifications on the equipment;
- use of the burner with safety devices that are faulty, incorrectly applied and/or not working;
- installation of untested supplementary components on the burner;
- powering of the burner with unsuitable fuels;
- faults in the fuel supply system;
- continuation of use of the burner when a fault has occurred;
- repairs and/or overhauls incorrectly carried out;
- modification of the combustion chamber with inserts that prevent the regular development of the structurally established flame;
- insufficient and inappropriate surveillance and care of those burner components most likely to be subject to wear and tear;
- use of non-original components, including spare parts, kits, accessories and optional;
- force majeure.

The manufacturer furthermore declines any and every responsibility for the failure to observe the contents of this manual.

1.2.1 Owner's responsibility

Please pay attention to the Safety Warnings contained within this instruction manual. Keep this manual for your records and provide it to your qualified service agency for use in professionally setting up and maintaining your burner.

Your burner will provide years of efficient operation if it is professionally installed and maintained by a qualified service technician. If at any time the burner does not appear to be operating properly, immediately contact your qualified service agency for consultation.

We recommend annual inspection/service of your gas heating system by a qualified service agency.

Failure to follow these instructions, misuse, or incorrect adjustment of the burner could lead to equipment malfunction and result in asphyxiation, explosion or fire.



WARNING

If you smell gas:

- Do not touch any electrical items.
- Open all windows.
- Close all gas supply valves.
- Contact your local gas authority immediately.
- Do not store flammable or hazardous materials in the vicinity of fuel burning appliances.
- Improper installation, adjustment, alteration, service or maintenance can cause property damage, personal injury or death.
- Refer to this manual for instructional or additional information.
- Consult a certified installer, service representative or the gas supplier for further assistance.
- Burner shall be installed in accordance with manufacturers requirements as outlined in this manual, local codes and authorities having jurisdiction.



WARNING

CANADA: The equipment shall be installed in accordance with the Provincial Installation Requirements, or in their absence, the CAN/CGA B149.1 & B149.2 Installation Codes shall prevail. Authorities having jurisdiction should be consulted before installation is made.

USA: This burner must conform with local codes, or, in the absence of local codes, with the Standard: National Fuel Gas Code NFPA 54/ANSI Z223.1 or International Fuel Gas Code, as appropriate.

If an external electrical source is utilized, the conversion burner, when installed, must be electrically grounded in accordance with local codes or, in the absence of local codes, with the national Electrical Code, ANSI/NFPA No. 70-1990 and CSA Electrical Code C22.2 No.0 M1982 & C22.2 No 3. 1988. **Authorities having jurisdiction should be consulted before installations are made. The owner is required to retain this manual for future reference.**

2.1 Introduction

The burners have been designed and built in compliance with current regulations and directives, applying the known technical rules of safety and envisaging all the potential danger situations.

It is necessary, however, to bear in mind that the imprudent and clumsy use of the equipment may lead to situations of death risk for the user or third parties, as well as the damaging of the burner or other items. Inattention, thoughtlessness and excessive confidence often cause accidents; the same applies to tiredness and sleepiness.

It is a good idea to remember the following:

- The burner must only be used as expressly described. Any other use should be considered improper and therefore dangerous.

In particular:

it can be applied to boilers operating with water, steam, diathermic oil, and to other uses expressly foreseen by the manufacturer;

the type and pressure of the fuel, the voltage and frequency of the electrical power supply, the minimum and maximum deliveries for which the burner has been regulated, the pressurisation of the combustion chamber, the dimensions of the combustion chamber and the room temperature must all be within the values indicated in the instruction manual.

- Modification of the burner to alter its performance and destinations is not allowed.
- The burner must be used in exemplary technical safety conditions. Any disturbances that could compromise safety must be quickly eliminated.
- Opening or tampering with the burner components is not allowed, apart from the parts requiring maintenance.
- Only those parts envisaged by the manufacturer can be replaced.



The manufacturer guarantees safety and proper functioning only if all burner components are intact and positioned correctly.

2.2 Personnel training

The user is the person, body or company that has acquired the machine and intends to use it for the specific purpose. He is responsible for the machine and for the training of the people working around it.

The user:

- undertakes to entrust the machine exclusively to suitably trained and qualified personnel;
- undertakes to inform his personnel in a suitable way about the application and observance of the safety instructions. With that aim, he undertakes to ensure that everyone knows the use and safety instructions for his own duties;
- Personnel must observe all the danger and caution indications shown on the machine.
- Personnel must not carry out, on their own initiative, operations or interventions that are not within their province.
- Personnel must inform their superiors of every problem or dangerous situation that may arise.
- The assembly of parts of other makes, or any modifications, can alter the characteristics of the machine and hence compromise operating safety. The manufacturer therefore declines any and every responsibility for any damage that may be caused by the use of non-original parts.

In addition:



- must take all the measures necessary to prevent unauthorised people gaining access to the machine;
- the user must inform the manufacturer if faults or malfunctioning of the accident prevention systems are noticed, along with any presumed danger situation;
- personnel must always use the personal protective equipment envisaged by legislation and follow the indications given in this manual.

3 Technical description of the burner

3.1 Technical data

Model		RX 150 S/PV		
Output ⁽¹⁾ Delivery ⁽¹⁾	max.	MBtu/hr kW	550 160	
	min.	MBtu/hr kW	80 24	
Fuel	type	Natural Gas		Propane
- max. delivery	SCFH	550		220
- gas head pressure at max. delivery ⁽²⁾	"wc	-7.5		-10.35
- supply pressure	"wc	4 - 14		4 - 14
Operation		Modulating		
Standard applications		Boilers: water, steam, thermal oil		
Ambient temperature	°F	32 - 104 (0 - 40 °C)		
Combustion air temperature	°F max	140 (60 °C)		

Tab. A

- ⁽¹⁾ Reference conditions: ambient temperature 68 °F (20°C) - Barometric pressure 394" WC - Altitude 329 ft.
⁽²⁾ Pressure at test point 6)(Fig. 3 at page 9) with zero pressure in the combustion chamber and maximum burner output.

3.2 Electrical data

Model		RX 150 S/PV	
Control circuit power supply	V/Ph/Hz	120/1/50-60	
Main power supply (+/- 10%)	V/Ph/Hz	120/1/50-60	
Fan motor	rpm	8400	
	V	120	
	HP	0.34	
	A	3.5	
Ignition transformer	V1 - V2	120 V - 1 x 15 kV	
	I1 - I2	0.48 A - 30 mA	
Electrical power consumption	W	300	
Electrical control circuit consumption	W max	110	
Total electrical consumption	W	410	
Electrical protection		NEMA 1	

Tab. B

3.3 Packaging - weight - Approximate measurements

The packaging of the burner (Fig. 1) rests on a wooden platform that is particularly suitable for lift trucks. The dimensions of the packaging are shown in the Tab. C.

The weight of the burner complete with its packaging is shown in Tab. C.

inch	A	B	C	lbs
RX 150 S/PV	30 41/64"	18 3/4"	15 43/64"	24.25

Tab. C

The dimensions of the combustion head packaging are shown in the Tab. D.

The weight of the combustion head complete with its packaging is shown in Tab. D.

inch	A	B	C	lbs
RX 150 S/PV	28 3/4"	6 1/2"	6 1/2"	3.7

Tab. D

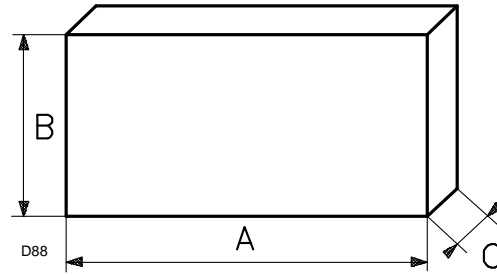

Fig. 1

3.4 Burner dimensions

The maximum dimensions of the burner are given in Fig. 2.

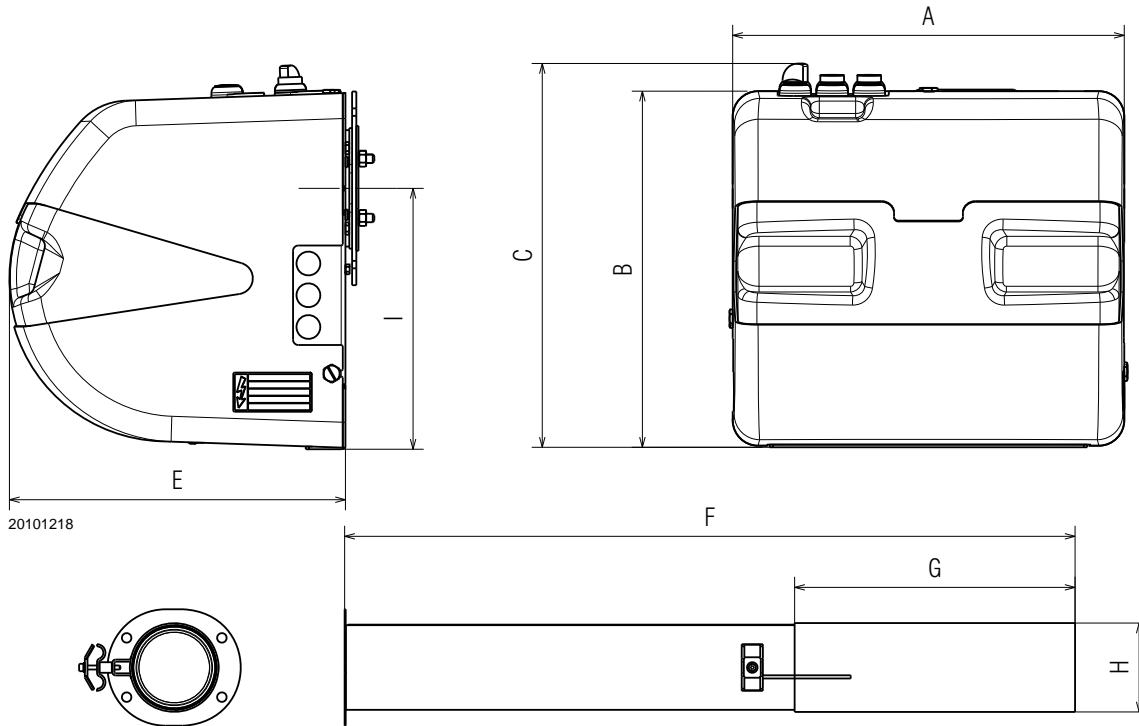

Fig. 2

inch	A	B	C	E	F	G	H	I
20048844	14 37/64"	13 1/4"	14 19/64"	12 1/2"	27 11/64"	10 7/16"	3 5/16"	9 25/32"
20121231	14 37/64"	13 1/4"	14 19/64"	12 1/2"	19 11/16"	10 7/16"	3 5/16"	9 25/32"

Tab. E

3.5 Burner description

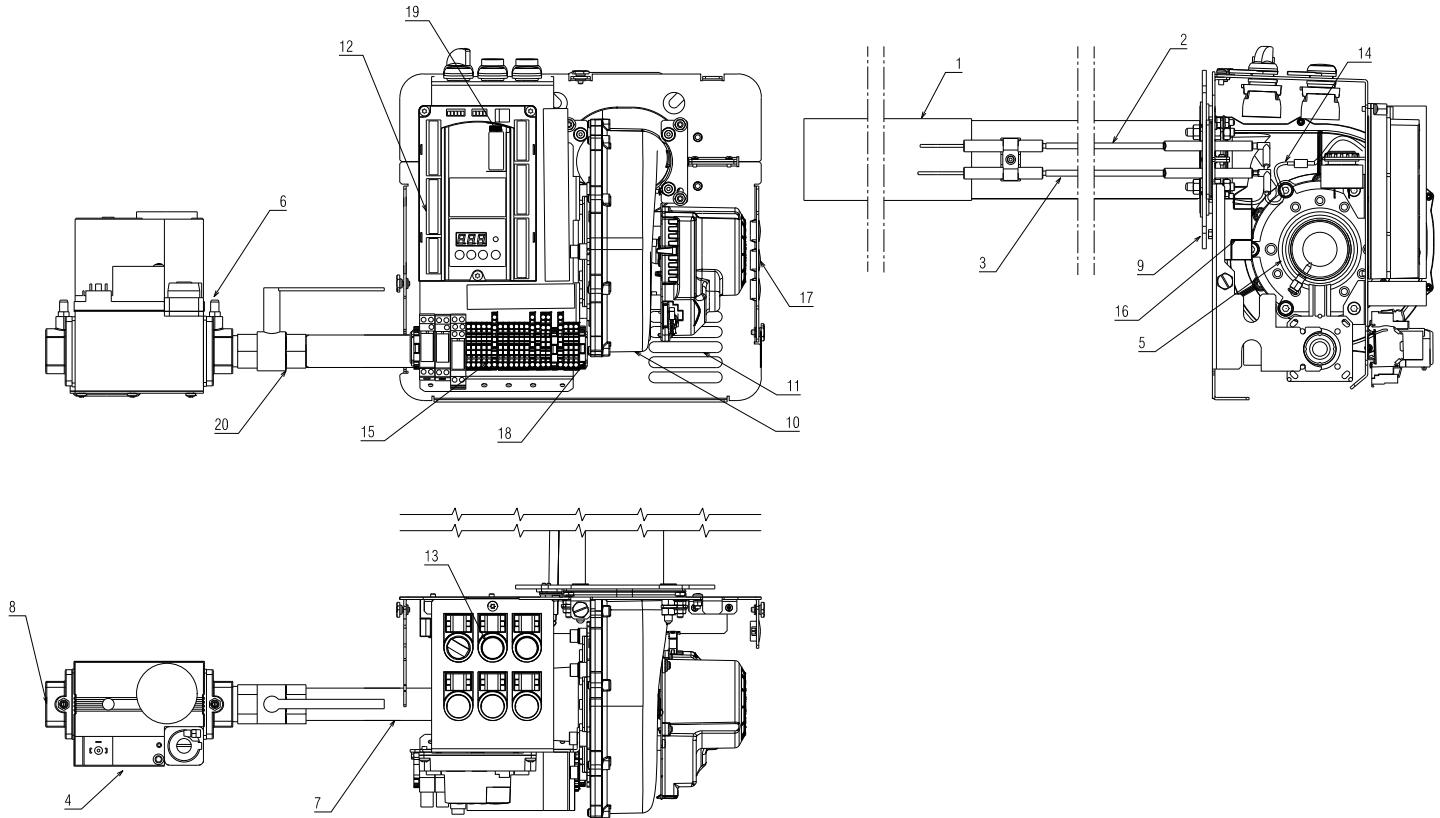

Fig. 3

- | | | | |
|----|---|----|--|
| 1 | Combustion head (delivered separately) | 14 | Plug-socket on ionisation probe cable |
| 2 | Ignition electrode (delivered separately) | 15 | Terminal board |
| 3 | Flame sensor probe (delivered separately) | 16 | Transformer |
| 4 | Gas valve | 17 | Plate with four hole knock-outs for electrical cable routing |
| 5 | Air/gas mixer in the suction line circuit - Venturi | 18 | Fuse-holder |
| 6 | Gas pressure test point | 19 | Program module |
| 7 | Gas valve conduit | 20 | Safety shut off valve |
| 8 | Gas input | | |
| 9 | Boiler fixing flange | | |
| 10 | Fan | | |
| 11 | Air passage in fan | | |
| 12 | Control box with lockout pilot light | | |
| 13 | Reset button | | |

Burner lockout may occur:

- **control box lockout**
If the push-button 13)(Fig. 3) lights up, it indicates that the burner is in lockout. Press the push button to reset.

3.6 Burner equipment

Flange fixing screws M 5 x 20 - grover washer and flanged nut	No. 4
Insulating gasket	No. 1
Instruction booklet	No. 1
Hardware for burner assembly:	
8 x 50 stainless steel nuts (with or without point)	No. 4
M8 zinc-plated nuts	No. 4
Gas pipe	No. 1
Air/gas compensation pipe	No. 1
Label "Tested"	No. 1



The equipment shall be installed in accordance with the Provincial Installation Requirements, or in their absence, the CGA B149.1 and B149.2 Installation Codes shall prevail. Authorities having jurisdiction should be consulted before installations are made. The owner is required to retain this manual for future reference.

3.7 Firing rates

During operation, burner output varies between:

- a **MAXIMUM OUTPUT**, which must not be greater than the maximum limit given on the diagram,
- and a **MINIMUM OUTPUT**, which must not be lower than the minimum limit in the diagram.

—————	NOX < 30 ppm
- - - - -	NOX < 20 ppm
· · · · ·	NOX < 9 ppm
- · - · -	Ignition

Tab. F



The firing rate value range has been obtained considering an ambient temperature of 68 °F (20 °C), and an atmospheric pressure of 394" WC.

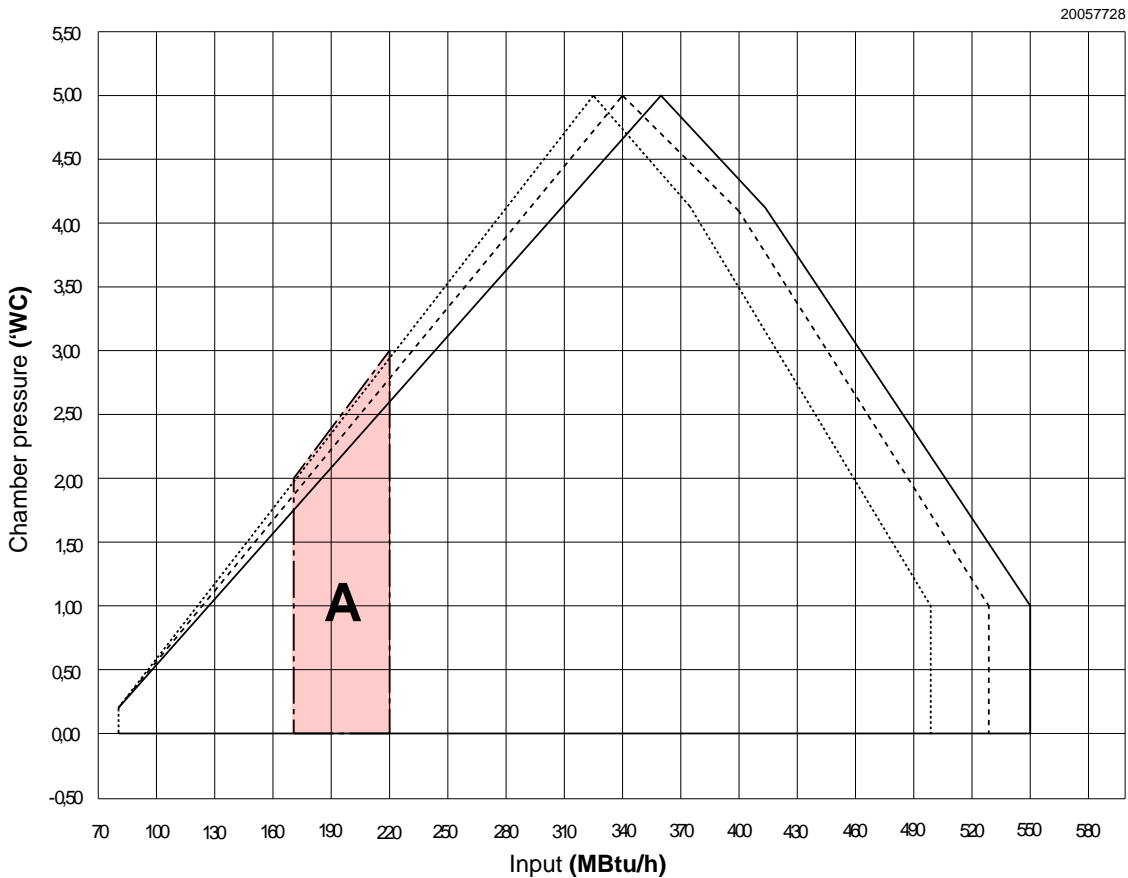

Fig. 4

NOx expected emissions on natural gas (expressed in ppm@3% O₂)

Sub 30		Sub 20		Sub 9	
CO ₂ (%)	O ₂ (%)	CO ₂ (%)	O ₂ (%)	CO ₂ (%)	O ₂ (%)
8.5 ~ 8.75	5.8 ~ 5.4	8.0 ~ 8.5	6.7 ~ 5.8	7.25 ~ 7.75	8.0 ~ 7.1

Tab. G

3.8 Burner controls (LME71...)

Warning notes



WARNING

To avoid injury to persons, damage to property or the environment, the following warning notes must be observed!

The LME71... are safety devices! Do not open, interfere with or modify the unit.

Riello S.p.A. does not assume responsibility for damage resulting from unauthorized interference! Additional safety notes contained in other chapters of this document must be observed as well!



WARNING

Only qualified personnel are allowed to install and operate the equipment.

Qualified personnel in the context of the safety-related notes contained in this document are persons who are authorized to commission, ground and tag devices, systems and electrical circuits in compliance with established safety practices and standards.

- All activities (mounting, installation and service work, etc.) must be performed by qualified personnel.
- Before making any wiring changes in the connection area, completely isolate the plant from mains supply (all-polar disconnection). Ensure that the plant cannot be inadvertently switched on again and that it is indeed dead. If not observed, there is a risk of electric shock hazard.
- Ensure protection against electric shock hazard by providing adequate protection for the burner control's connection terminals (e. g. with dummy plugs for inputs and outputs not used). If not observed, there is a risk of electric shock hazard.
- The space where the program module (Fig. 6) is located is defined as plugging space and therefore back-off-hand-proof when the program module is not fitted.
- If the housing or the area near the operating panel is damaged, the unit must immediately be put out of operation. If not observed, there is a risk of electric shock hazard.
- Press the buttons on the operating panel only manually without using any tools or pointed objects. If the film of the operating panel is damaged, there is a risk of electric shock hazard.

To ensure safety and reliability of the LME71... system, the following points must also be observed:

- condensation and ingress of humidity must be avoided. Should such conditions occur, make sure that the unit will be completely dry before switching on again! If not observed, there will be a risk of electric shock.
- Static charges must be avoided since they can damage the unit's electronic components when touched.



WARNING

Condensation, formation of ice and ingress of water are not permitted!

If not observed, there is a risk of impairment of safety functions and of electric shock hazard.



S8593

Fig. 5

Program module



S8673

Fig. 6

Mounting notes

- Ensure that the relevant national safety regulations are complied with
- The LME7... basic unit must be secured with fixing screws M4 (UNC32) or M5 (UNC24), observing a maximum tightening torque of 1.8 Nm and using all 3 fixing points. The additional mounting surfaces on the housing are provided to improve mechanical stability. These must fully rest on the mounting surface to which the unit is secured. The flatness of that mounting surface must be within a tolerance band of 0.3 mm.

Installation notes

- Always run the high-voltage ignition cable separate from the unit and other cables while observing the greatest possible distance.
- Do not mix up live and neutral conductors.
- Install switches, fuses and earthing in compliance with local regulations.
- The connection diagrams show the burner controls with earthed neutral conductor.
- Make certain that the maximum permissible current rating of the connection terminals is not exceeded.
- Make certain that strain relief of the connected cables is in compliance with the relevant standards.
- Do not feed external mains voltage to the control outputs of the unit. When testing the devices controlled by the burner control (fuel valves, etc.), the LME71... must not be connected to the units.
- The mechanical coupling between the actuators and the controlling elements for fuel and air, or any other controlling elements, must be rigid.
- Check the connecting lines of the air pressure switch for short-circuits.

Electrical connection of flame detectors

It is important to achieve practically disturbance- and loss-free signal transmission:

- Never run the detector cable together with other cables:
 - line capacitance reduces the magnitude of the flame signal;
 - use a separate cable.
- Observe the permissible detector cable lengths (see Technical Data).
- The mains-powered ionization probe is not protected against electric shock hazard.
- Locate the ignition electrode and the ionization probe such that the ignition spark cannot arc over to the ionization probe (risk of electrical overloads) and that it cannot adversely affect the supervision of ionization.

Description of display and buttons

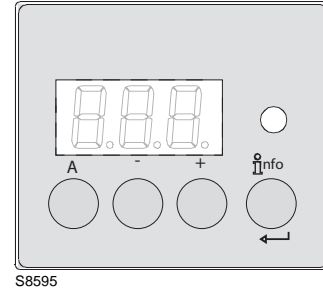

Fig. 7





Button	Function
	<p>Button A</p> <ul style="list-style-type: none"> – Display preset output – In lockout position: power value to the time of fault
	<p>Info and Enter Button</p> <p>The lockout reset button (info button) is the key operating element for resetting the burner control and for activating/deactivating the diagnostics functions.</p>
	<p>- Button</p> <ul style="list-style-type: none"> – Display flame signal current 2 or phases display – In lockout position: MMI phase to the time of fault
	<p>+ Button</p> <ul style="list-style-type: none"> – Display flame signal current 1 or phases display – In lockout position: MMI phase to the time of fault
	<p>3 multicolor signal lamp</p> <p>The multicolor signal lamp (red - yellow - green) is the key indicating element for visual diagnostics.</p>
	<p>+ and - Button: escape function</p> <p>Press + and - button simultaneously!</p> <ul style="list-style-type: none"> – No adoption of value – One menu level up – Keep depressed for >1second for backup/re-store function

Tab. H

Technical data

LME71... burner controls	Mains voltage	AC 120 V
	Mains frequency	50 / 60 Hz
	Power consumption	<10 W, typical
	External primary fuse	Max. 6.3 A (slow)
	Safety class	I with parts according to II and III to DIN EN 60730-1
Terminal rating "Inputs"	Under voltage	UMains 120 V
	• Safety shutdown from the operating position takes place should mains voltage drop	< AC 75 V
	• Restart is initiated when mains voltage exceeds	> AC 100 V
	Input currents and input voltages	
	– UeMax	UN +10%
	– UeMin	UN -15%
	– IeMax	1.5 mA peak (peak value)
	– IeMin	0.8 mA peak (peak value)
	Voltage detection	
	– ON	> AC 60 V
– OFF	< AC 40 V	
Terminal rating "Outputs"	Total contact loading:	
	Rated voltage	AC 120 V - 50/60 Hz
	Unit input current X3-04 (safety loop) from:	Max. 5 A
	– fan motor contactor	
	– ignition transformer	
	– fuel valves	
	Individual contact loading:	
	Fan motor contactor X2-01 pin 3	
	– Rated voltage	AC 120 V 50/60 Hz
	– Rated current	2 A (15A max. 0.5 s)
	– Power factor	Cosφ ≥ 0.4
	Alarm output X2-03/3	
	– Rated voltage	AC 120 V 50/60 Hz
	– Rated current	1 A
	– Power factor	Cosφ > 0.6
	Ignition transformer X4-02 pin 3	
	– Rated voltage	AC 120 V 50/60 Hz
	– Rated current	2 A
	– Power factor	Cosφ > 0.4
	Auxiliary output	
	– Rated voltage	AC 120 V 50/60 Hz
	– Rated current	1 A
	– Power factor	Cosφ > 0.6
	Output relay contact 2 pin 2 X2-09 pin 7	
	– Rated voltage	AC 120 V 50/60 Hz
	– Rated current	1 A
	– Power factor	Cosφ > 0.4
Fuel valves/pilot valve X7-01 pin 3		
– Rated voltage	AC 120 V 50/60 Hz	
– Rated current	1 A	
– Power factor	Cosφ > 0.4	
Safety valve X6-03 pin 3		
– Rated voltage	AC 120 V 50/60 Hz	
– Rated current	1.5 A	
– Power factor	Cosφ > 0.6	
Cable lengths	Mains supply line	Max. 100 m (100 pF/m)
Cross-sectional areas	The cross-sectional areas of the mains power lines (L, N, and PE) and, if required, the safety loop (safety limit thermostat, water shortage, etc.) must be sized for rated currents according to the selected external primary fuse. The cross-sectional areas of the other cables must be sized in accordance with the internal unit fuse (max. 6.3 AT).	
Environmental conditions	Operation	DIN EN 60721-3-3
	Climatic conditions	Class 3K3
	Mechanical conditions	Class 3M2
	Temperature range	-40...+60 °C
	Humidity	<95% r.h.

Key Fig. 8:

AL	Alarm device
AUX	Auxiliary output
Dbr	Wire link
 (EK1)	Lockout reset button (info button)
EK2	Remote lockout reset button
FSV	Flame signal amplifier
ION	Ionization probe
K...	Relay contact
LED	3-color signal lamp
LP	Air pressure switch
LR	Load controller
LR-OPEN	Load controller OPEN position
LR-CLOSE	Load controller CLOSED position
M	Fan motor
NT	Power supply unit
P LT	Pressure switch valve proving
Pmax	Pressure switch-max
Pmin	Pressure switch-min
POC	Proof of closure
PV	Pilot valve
QRA...	UV flame detector
R	Control thermostat or pressurestat
SA	Actuator
SA-KL	Actuator low-fire
SA-NL	Actuator high-fire
SA-R	Actuator feedback
SA-Z	Actuator CLOSED
SA-ZL	Actuator ignition load
SL	Safety loop
STB	Safety limit thermostat
SV	Safety valve
V1	Fuel valve
V2	Fuel valve
V2a	Fuel valve
W	Limit thermostat or pressure switch
Z	Ignition transformer
µC	µC controller
	Input/output signal 1 (ON)
	Input/output signal 2 (OFF)
	Input permissible signal 1 (ON) or 0 (OFF)

Tab. J

Times

TSA	Safety time
tw	Waiting time
t1	Prepurge time
t3	Preignition time
t3n	Postignition time (P257 +0.3 seconds)
t4	Interval: end of safety time load controller release
t5	Interval: Pilot valve OFF - load controller release
t8	Postpurge time
t10	Specified time air pressure switch state message (timeout)
t11	Opening time of actuator (timeout)
t12	Closing time of actuator (timeout)
td1	Test atmospheric pressure
td2	Test gas pressure
td3	Test space filling
td4	Test space evacuating

Tab. K

Key to Phases (Fig. 8, page 14):

Phase number	Function
LOC	Lockout shutdown phase
OFF	Standby, waiting for heat request
oP	Part 1: request load controller OPEN Part 2: modulation of fan motor speed toward high-fire Part 3: high-fire reached Part 4: request load controller CLOSED Part 5: modulation of fan motor speed toward low-fire Part 6: low-fired reached
10	Settling time, fan motor standby speed
21	Safety valve ON, air pressure switch in no-load position Check if POC is closed, fan motor speed is reduced to 0
22	Part 1: fan motor ON Part 2: specified time air pressure switch Message (timeout), stabilization of air pressure switch
24	Settling time, fan motor prepurge speed
30	Part 1: prepurge time without flame simulation test Part 2: prepurge time with flame simulation test (2.1 seconds)
36	Speed settling time, fan motor ignition load speed
38	Preignition time
40	Postignition time, parameter 257 + 0.3 seconds
42	Flame detection
44	Interval: end of ignition safety time and release of load controller
72	Speed stabilization time, fan motor postpurge speed
74	Part 1: operation is ended, check if postpurging is programmed Part 2: postpurge time
80	Test space is evacuated
81	Atmospheric pressure test
82	Test space is filled
83	Gas pressure test
90	Pressure switch-min open --> safety shutdown
*1	Valve proving, if P241 = 1 after main ON, lockout or P234 (postpurge time) = 0 second
*2	Valve proving, if P241 = 1 and P234 (postpurge time) >0 second

Tab. L

3.8.1 Indication of diagnostics mode



The lockout reset button (info button) is the key operating element for resetting the burner control and for activating/deactivating the diagnostics functions.

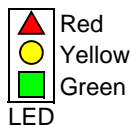

The multicolor signal lamp is the key indicating element for visual diagnostics.

Both lockout reset button and signal lamp are located in the control panel.

There are 2 diagnostics choices:

- 1 Visual diagnostics: Indication of operating state or diagnostics of cause of fault
- 2 Diagnostics: Via BCI to AZL2... display and operating unit

Visual diagnostics:

in normal operation, the different operating states are indicated in the form of color codes according to the color code table given below (Tab. M).

Indication of operating state

During startup, state indication takes place according to the Tab. M:

Color code table for multicolor signal lamp

State	Color code	Color
Waiting time, other waiting states	○.....	OFF
Ignition phase, ignition controlled	● ○ ● ○ ● ○ ● ○	Blinking yellow
Operation, flame o.k.	■.....	Green
Operation, flame not o.k.	■ ○ ■ ○ ■ ○ ■ ○	Blinking green
Extraneous light on burner startup	■ ▲ ■ ▲ ■ ▲ ■ ▲	Green - Red
Undervoltage	● ▲ ● ▲ ● ▲ ● ▲	Yellow - Red
Fault, alarm	▲.....	Red
Error code output (see Error code Tab. AB, page 43)	▲ ○ ▲ ○ ▲ ○ ▲ ○	Blinking red
Interface diagnostics	▲ ▲ ▲ ▲ ▲ ▲ ▲ ▲	Red flicker light
Heating request	●.....	Yellow
New program card	● ● ▲ ● ● ▲ ● ●	Yellow Yellow - Red

Tab. M

Key (Tab. M)

- Steady on
- OFF
- ▲ Red
- Yellow
- Green

4

Installation

4.1 Notes on safety for the installation

After carefully cleaning all around the area where the burner will be installed, and arranging the correct lighting of the environment, proceed with the installation operations.



All the installation, maintenance and disassembly operations must be carried out with the electricity supply disconnected.



The installation of the burner must be carried out by qualified personnel, as indicated in this manual and in compliance with the standards and regulations of the laws in force.



Combustion air inside the boiler must be free from hazardous mixes (e.g.: chloride, fluoride, halogen); if present, it is highly recommended to carry out cleaning and maintenance more frequently.

**AIR FOR COMBUSTION**

Do not install burner in room with insufficient air for combustion. Be sure there is an adequate air supply for combustion if the boiler room is enclosed. It may be necessary to create a window to permit sufficient air to enter the boiler room.

The installer must follow local ordinances in this regard.

CANADA: It is suggested that the installer follow CAN/CGA B149.1 & B149.2 as appropriate.

USA: It is suggested that the installer follow NFPA 54/ANSI Z223.1 or International Fuel Gas Code, as appropriate.

CHIMNEY

Be sure chimney is sufficient to handle the exhaust gases. It is recommended that only the burner be connected to the chimney. Be sure that it is clean and clear of obstructions.

4.2 Handling

The burner packaging includes a wooden platform, it is therefore possible to move the burner (still packaged) with a transpallet truck or fork lift truck.



The handling operations for the burner can be highly dangerous if not carried out with the greatest attention: keep any unauthorised people at a distance; check the integrity and suitability of the available means of handling.

Check also that the area in which you are working is empty and that there is an adequate escape area (i.e. a free, safe area to which you can quickly move if the burner should fall).

When handling, keep the load at not more than 10" from the ground.

**ELECTRICAL CONNECTIONS**

CANADA: All electrical connections should be done in accordance with the C.E.C. Part 1, and all local codes. The system should be grounded.

USA: All electrical connections should be done in accordance with the National Electrical Code, and all local ordinances. The system should be grounded.

CONTROL BURNER OPERATION

Check out the burner and explain its operation to the homeowner. Be sure to leave the Owner's Instruction sheet with the homeowner.

ELECTRICAL CONNECTIONS

In most localities, a number 14 wire should be used inside a metal conduit. The system should be grounded.

A service switch should be placed close to the burner on a fireproof wall in an easily accessible location.

FIRE EXTINGUISHER

If required by local codes, install an approved fire extinguisher.



After positioning the burner near the installation point, correctly dispose of all residual packaging, separating the various types of material.



Before proceeding with the installation operations, carefully clean all around the area where the burner will be installed.

4.3 Preliminary checks

Checking the consignment



After removing all the packaging, check the integrity of the contents. In the event of doubt, do not use the burner; contact the supplier.



The packaging elements (wooden cage or cardboard box, nails, clips, plastic bags, etc.) must not be abandoned as they are potential sources of danger and pollution; they should be collected and disposed of in the appropriate places.



The burner output must be within the boiler's firing rate.



A burner label, or any other component, that has been tampered with, removed or is missing, prevents the definite identification of the burner and makes any installation or maintenance work difficult.

4.4 Operating position



- The burner is designed to operate only in positions 1, 2, 4 and 5 (Fig. 9).
- Installation 1 is preferable, as it is the only one that allows the maintenance operations as described in this manual.
- Installations 2, 4 and 5 allow operations to be performed, but make maintenance and inspection of the combustion head more difficult.



- Any other position could compromise the correct operation of the appliance.
- Installation 3 is prohibited for safety reasons.

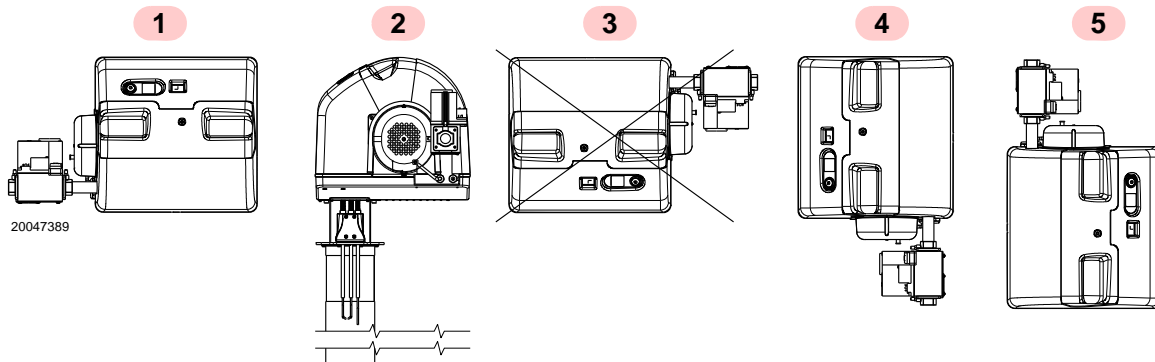

Fig. 9

4.5 Preparing the boiler

4.5.1 Boring the boiler plate

Pierce the closing plate of the combustion chamber, as in Fig. 10. The position of the threaded holes can be marked using the thermal insulation screen supplied with the burner.

inch	A	B	C	D
RX 150 S/PV	13/32"	5 29/32"	6 45/64"	45°

Tab. N

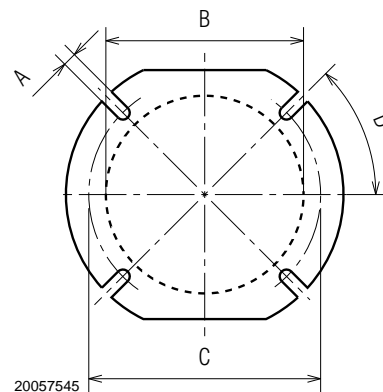

Fig. 10

4.5.2 Head length

The length of the head must be selected according to the indications provided by the manufacturer of the boiler, and in any case it must be greater than the thickness of the boiler door complete with its fettling.



The burners cannot be used on flame inversion boilers.

It is possible to insert a protective device made of refractory material between the combustion head and the boiler refractory.

This protective device must allow the blast tube to be taken out (Fig. 11).



Do not insert the protection in line with the electrode unit, as this would compromise its good operation.

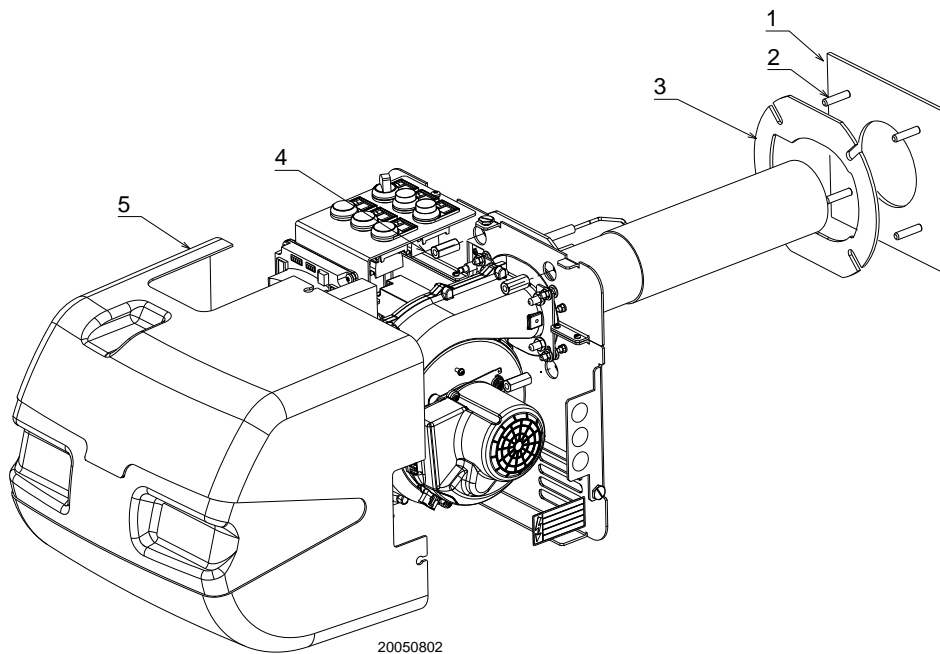

Fig. 11

4.6 Probe - electrodes positioning

The burners are supplied without the combustion head and electrodes already assembled.

NOTE:

In case of replacement of the electrodes, it is necessary to remove the electrical panel.



Before installing the burner on the boiler, make sure the probe and electrode are positioned correctly as in Fig. 12.

Do not turn the electrode: position it as illustrated. Placing the electrode near the ionization probe may result in the control box amplifier being damaged.

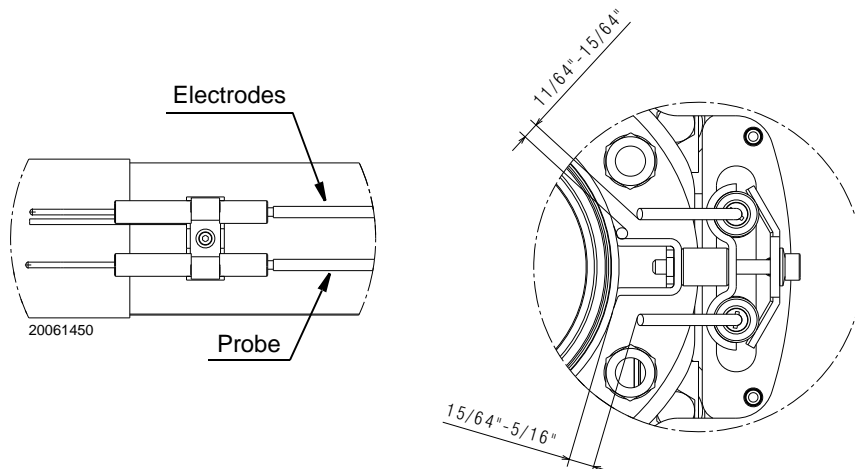

Fig. 12

4.7 Installation of combustion head, electrode and probe



DANGER

The installation, must be carried out with the electricity supply disconnected.

- Assemble the combustion head 1) to the burner 3) interposing the gasket 2) Fig. 13.
- Unscrew the screws 11), remove the 2 plates 12), the o-rings 13) and the gasket. See detail C.
- Insert the probe 4) and electrode 5) in the holes of the flange, indicated in the detail A.
- Insert the gasket, the first plate 12) and the o-ring 13) on the ceramics by closing with the second plate 12) and fixing with the 3 screws 11). See detail C.
- Unscrew the screw 7) and washer 6) fitted before hand on the combustion head, paying attention to plates 8), 9) and spacer 10). See detail B.



WARNING

Pay attention to the countersink of the plates, realised for the housing of the o-ring.

- Fix the probe 4) and the electrode 5) to the combustion head 1) between the two plates 8) and 9) using the screw 6), washer 7), the spacer 10) and the small threaded plate 14).



WARNING

Pay particular attention to the orientation of the probe and electrode tips, detail B.

- Insert the probe 10) and electrode 11) connections.

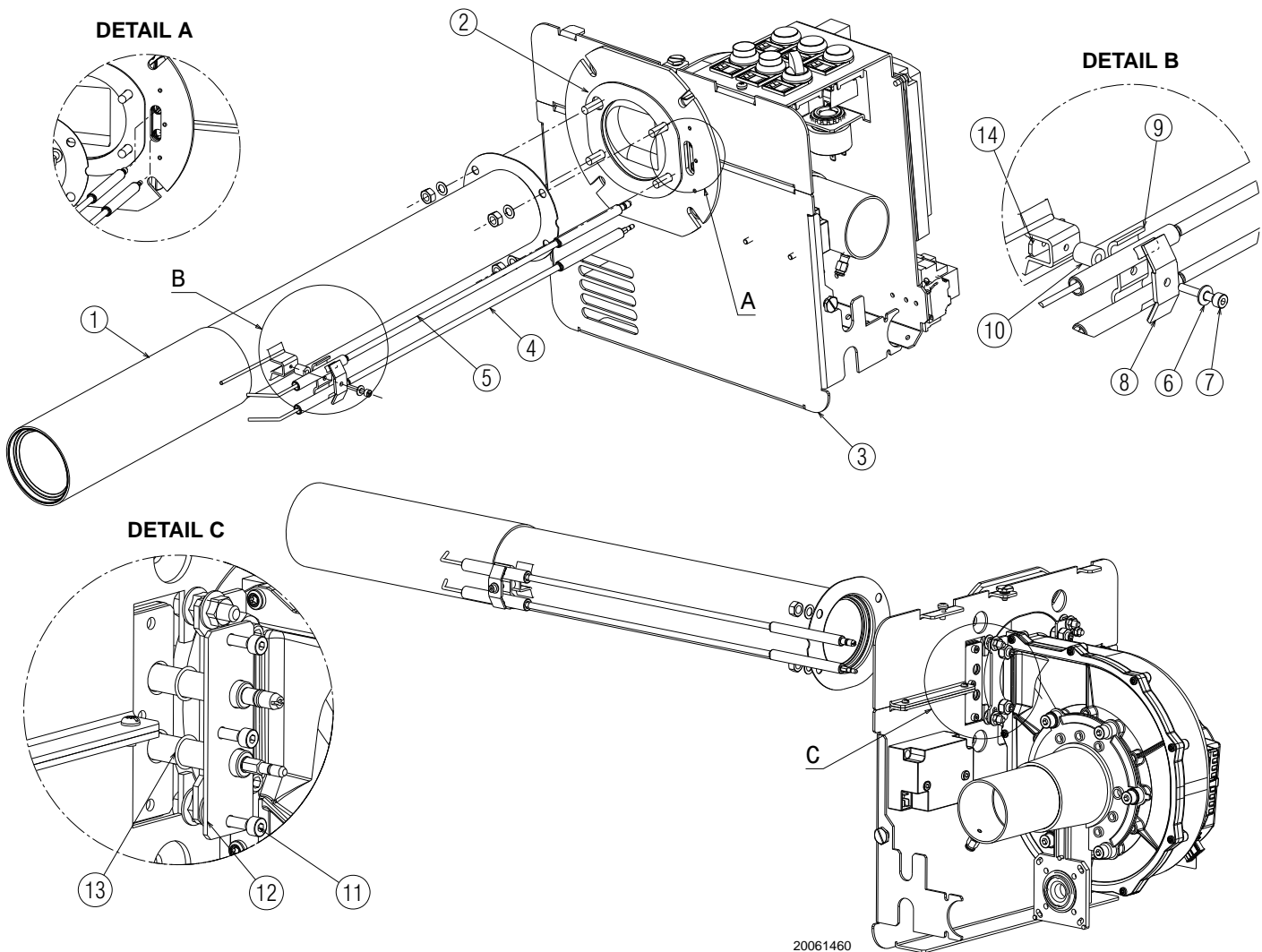

20061460

Fig. 13

4.8 Securing the burner to the boiler



Provide an adequate lifting system.

In order to fix the burner to the boiler, proceed as follows:

- Fix the train assembly 1)(Fig. 14). Interpose the gas pipe 3) the nuts, the grover washer 4), the gasket.
- Insert the gas compensation pipe between Venturi A and the pressure test point B.
- Screw the studs 2)(Fig. 11) onto the boiler plate 1).
- Position the refractory gasket 3)(Fig. 11).

- Fix the flange to the boiler plate and tighten the nuts 4)(Fig. 11).
- Insert the cover 5)(Fig. 11).



CAUTION

During this operation, take care not to touch the electrode unit.



WARNING

The seal between burner and boiler must be air-tight.

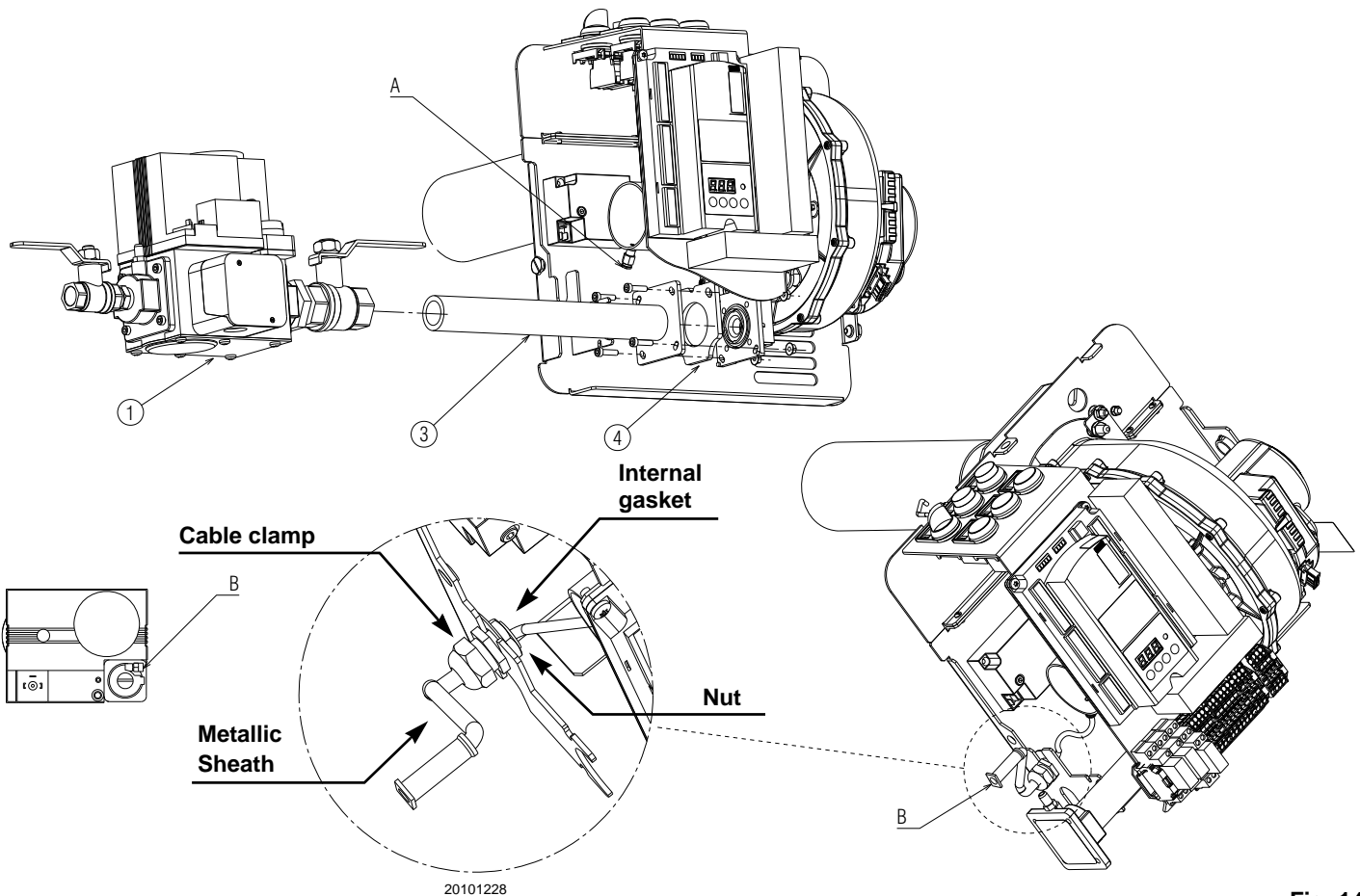

Fig. 14

4.9 Fuel supply



Explosion danger due to fuel leaks in the presence of a flammable source.

Precautions: avoid knocking, attrition, sparks and heat.

Make sure that the fuel inlet connection is closed before performing any operation on the burner.



WARNING

The fuel supply line must be installed by qualified personnel, in compliance with current standards and laws.

The burners are teamed with one-piece pneumatic proportioning gas valves, via which the amount of gas delivered, and hence the output produced, can be modulated.

A signal reporting pressure detected in the air circuit is carried to the pneumatic gas valve, which delivers an amount of gas in proportion to the airflow produced by the fan.

4.9.1 Air/gas mixer

Gas and combustible air are mixed inside the purging circuit (mixer), starting from the intake inlet.

Through the gas train, fuel is introduced into the intake air current and optimal mixing commences with the aid of a mixer.



CAUTION

Pipe (T) between valve-Venturi allows compensation to occur for accidental occlusion of the suction line due to a reduction in gas delivered.

After having connected the compensation pipe (T) with the valve, cover it again with the rubber protective device.

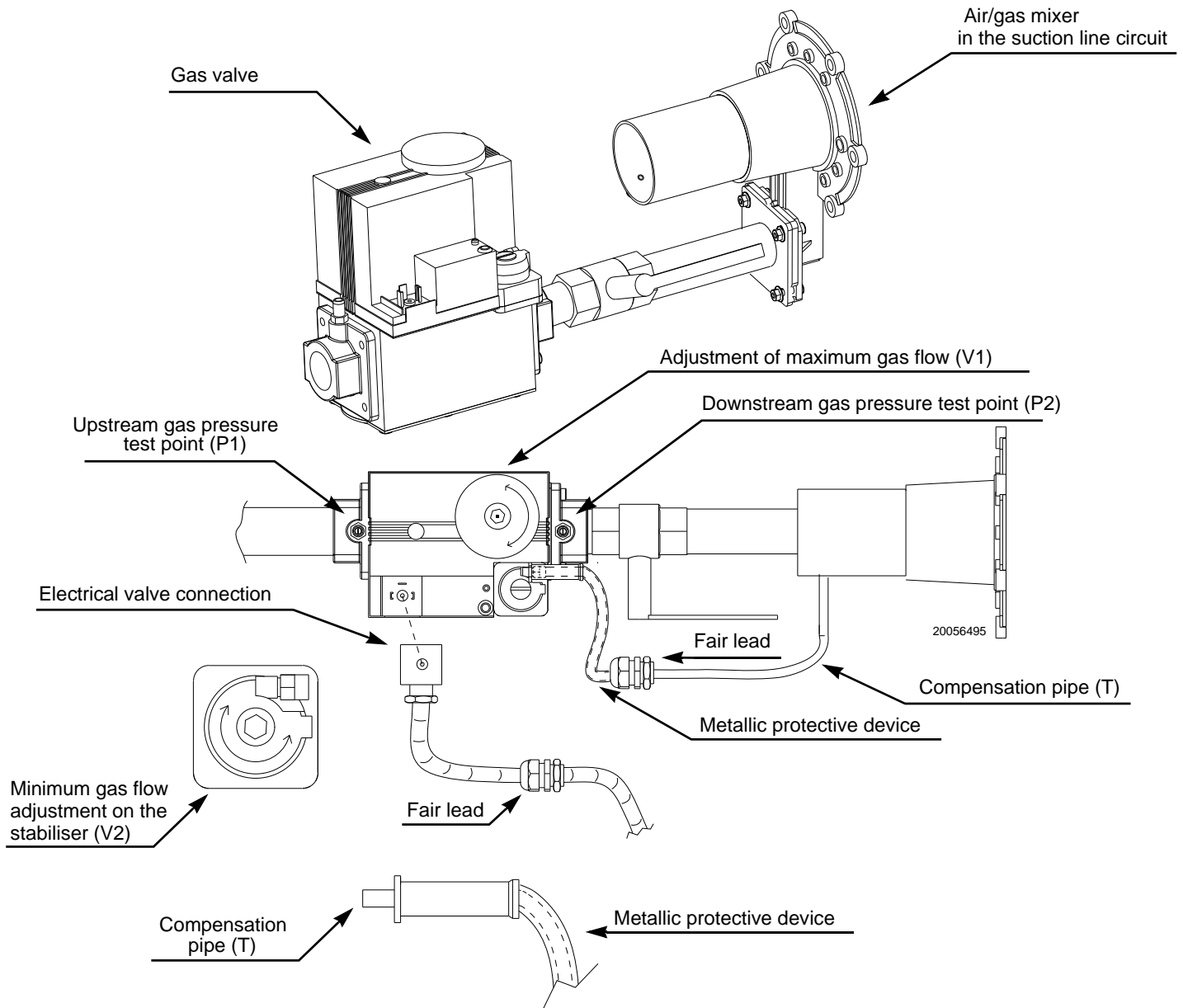

Fig. 15

4.9.2 Gas train

This has been type-approved in accordance with regulation NFPA 54/ANSI Z223.1 National Fuel Gas Code, NFPA 58 Liquefied Petroleum Gas Code, and International Fuel Gas Code, CAN/CGA B149.1 & B149.2 Installation Codes, and is supplied as standard (Fig. 16).



Before carrying out maintenance, cleaning or checking operations, identify and close the manual shut-off valve on the gas supply drop-line to the burner.

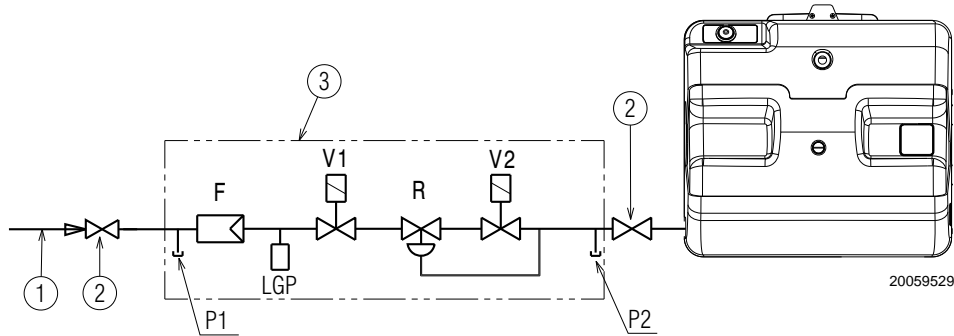

Fig. 16

Key (Fig. 16)

- 1 Gas supply
- 2 Manual valve
- 3 Valve including:
 - F screen/strainer
 - V1 1st SSOV
 - R pressure regulator
 - V2 2nd SSOV
- L Gas train supplied
- LGP Low gas pressure switch
- P1 Upstream gas pressure test point
- P2 Downstream gas pressure test point

4.10 Electrical wiring

Notes on safety for the electrical wiring



DANGER

- The electrical wiring must be carried out with the electrical supply disconnected.
- Electrical wiring must be made in accordance with the regulations currently in force in the country of destination and by qualified personnel. Refer to the wiring diagrams.
- The manufacturer declines all responsibility for modifications or connections different from those shown in the wiring diagrams.
- Check that the electrical supply of the burner corresponds to that shown on the identification label and in this manual.
- The burner has been type-approved for intermittent use. This means they should compulsorily be stopped at least once every 24 hours to enable the control box to perform checks of its own start-up efficiency. Normally, burner stopping is guaranteed by the boiler's thermostat/pressure switch.
- If this is not the case, a time switch should be fitted in series to TL to stop the burner at least once every 24 hours. Refer to the wiring diagrams.
- The electrical safety of the device is obtained only when it is correctly connected to an efficient earthing system, made according to current standards. It is necessary to check this fundamental safety requirement. In the event of doubt, have the electrical system checked by qualified personnel. Do not use the gas tubes as an earthing system for electrical devices.
- The electrical system must be suitable for the maximum power absorption of the device, as indicated on the label and in the manual, checking in particular that the section of the cables is suitable for that level of power absorption.
- For the main power supply of the device from the electricity mains:
 - do not use adapters, multiple sockets or extensions;
 - use a multiple pole switch with at least a 3mm gap between the contacts (overvoltage category III), as envisaged by the present safety standards.
- Do not touch the device with wet or damp body parts and/or in bare feet.
- Do not pull the electric cables.

Before carrying out any maintenance, cleaning or checking operations:



Before carrying out maintenance, cleaning or checking operations, identify and disconnect the main electrical power to the burner and identify and close the manual shut-off valve on the gas supply drop-line to the burner.



DANGER

Disconnect the electrical supply from the burner by means of the main system switch.



DANGER

Close the fuel inlet connection.



DANGER

Avoid condensate, ice and water leaks from forming.

If the cover is still present, remove it and proceed with the electrical wiring according to the wiring diagrams.

Use flexible metal conduit in compliance with the National Electrical Code, NFPA 70 and Parts 1 and 2 of the Canadian Electrical Code as appropriate.



After carrying out maintenance, cleaning or checking operations, reassemble the cover and all the safety and protection devices of the burner.

4.10.1 Supply cables and external connections passage

All the cables to be connected to the burner must be threaded through cable grommets. The use of the cable grommets can take various forms by way of example we indicate the following mode.

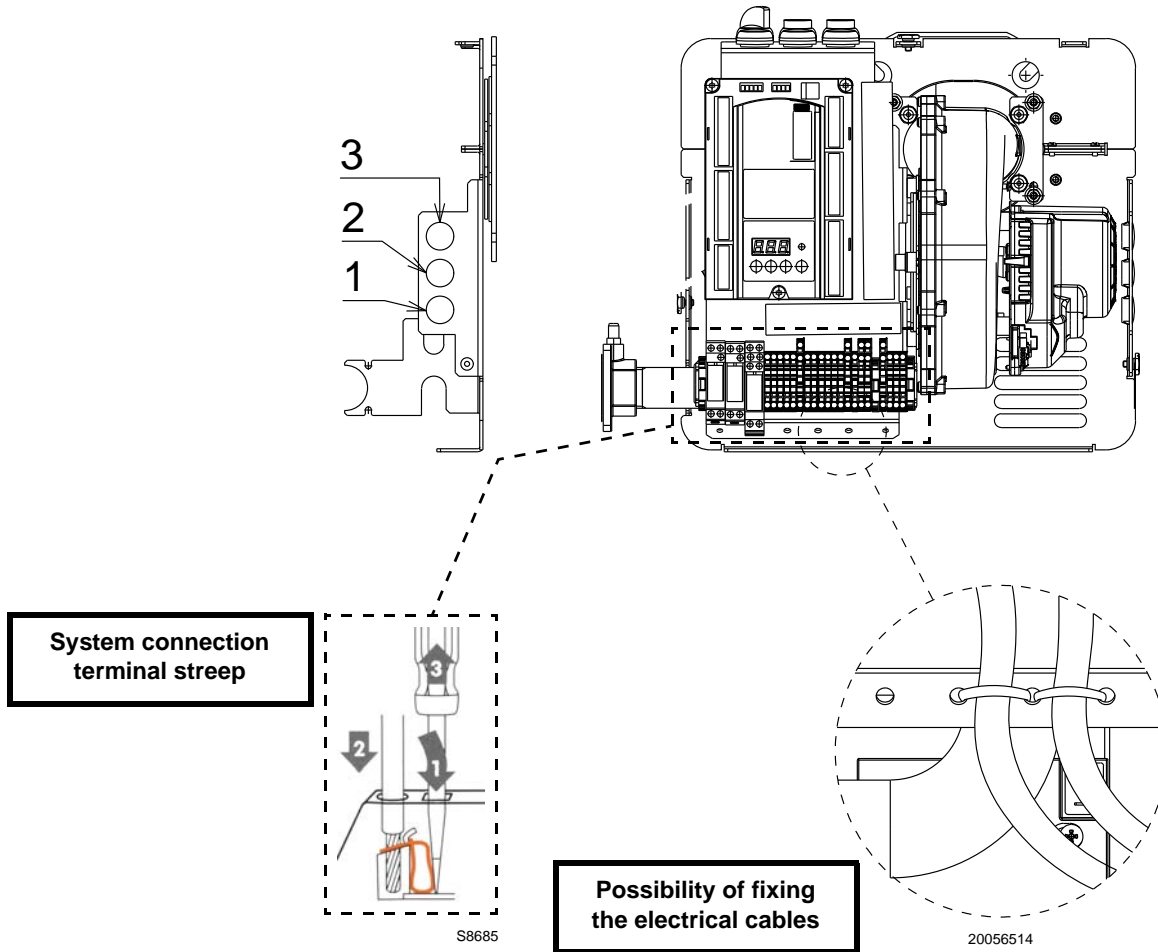

Fig. 17

Key (Fig. 17)

- 1 Single phase power supply, thermostat/pressure switch TL
- 2 Thermostat/pressure switch
- 3 Consents/safety
- 4 Available

Cable lengths

Mains supply line	Max. 100 m (100 pF/m)
Load controller X5-03	Max. 30 m (100 pF/m)
Safety Loop	Max. 30 m (100 pF/m)
Remote reset (lay separate cable)	Max. 30 m (100 pF/m)
Other lines	Max. 30 m (100 pF/m)

Tab. O

4.10.2 Factory wiring diagram

Control circuits

Burner operation may be controlled by either 120V or 24V control systems.

The required controls must be connected to the burner as described on the following.

120V control system

The burner provides its own power supply for the control circuits that is switched internal from terminal 1(L) & 2 (N), do not apply power on any other terminal or damaged to the control could occur.

The factory-installed jumper can be removed if a P.O.C device is desired.

24V control system

If firing is to be controlled by a 24V operating system a 24V switching relay wired as shown in the diagram is required (not supplied – sold separately).

The required 24V operating controls must be wired between the thermostat terminals on the 24V-switching relay.

The factory-installed jumper can be removed if a P.O.C device is desired.

NOTE:

If an external electrical source is utilized, the conversion burner, when installed, must be electrically grounded with a solid green wire to Earth Ground, in accordance with local codes or, in the absence of local codes, with the National Electrical Code ANSI/NFPA 70-1990 and the CSA Electrical Code.

WIRING DIAGRAM OF KIT DISPLAY

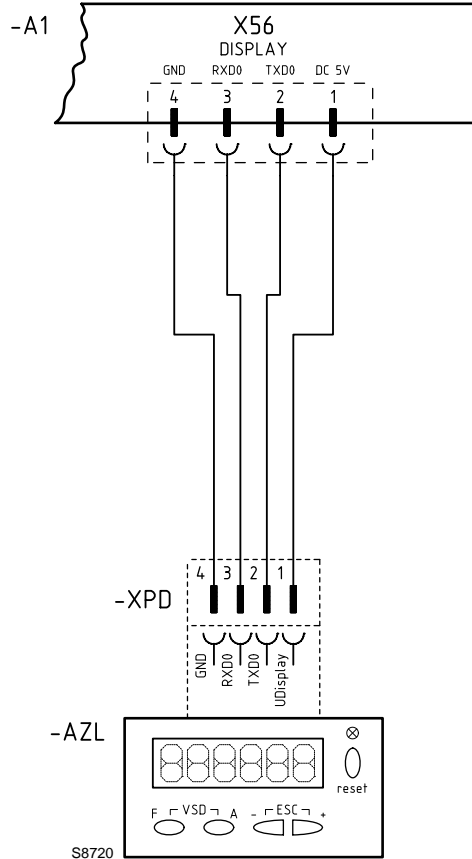
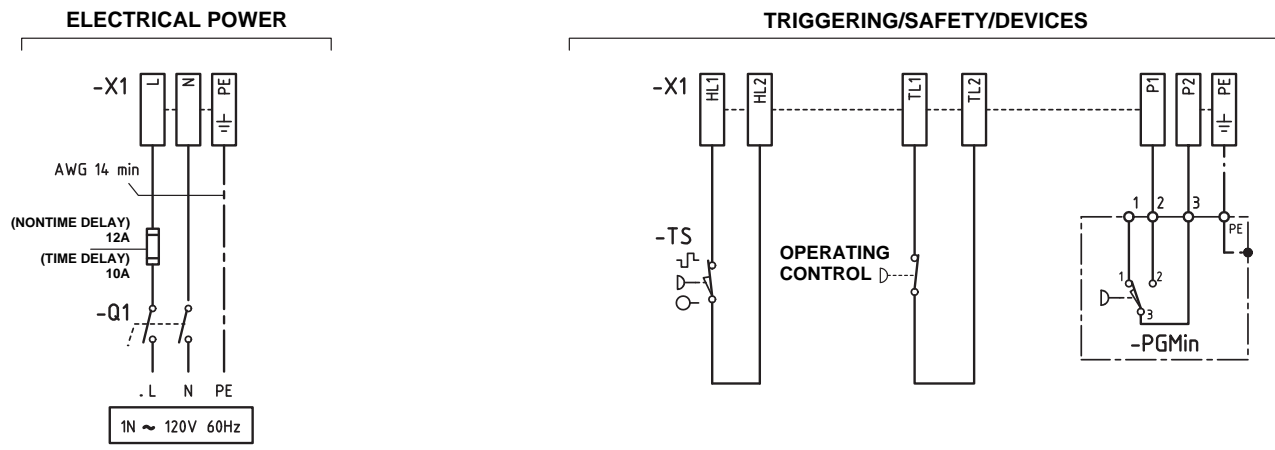

Fig. 18

Key (Fig. 18)

- A1 Control box for the air/fuel ratio
- AZL Operator panel
- XPD Operator panel connector

4.10.3 Wiring diagram (customer installation)



ATTENTION:
USE ONLY COPPER CONDUCTORS
CUSTOMER INSTALLATION

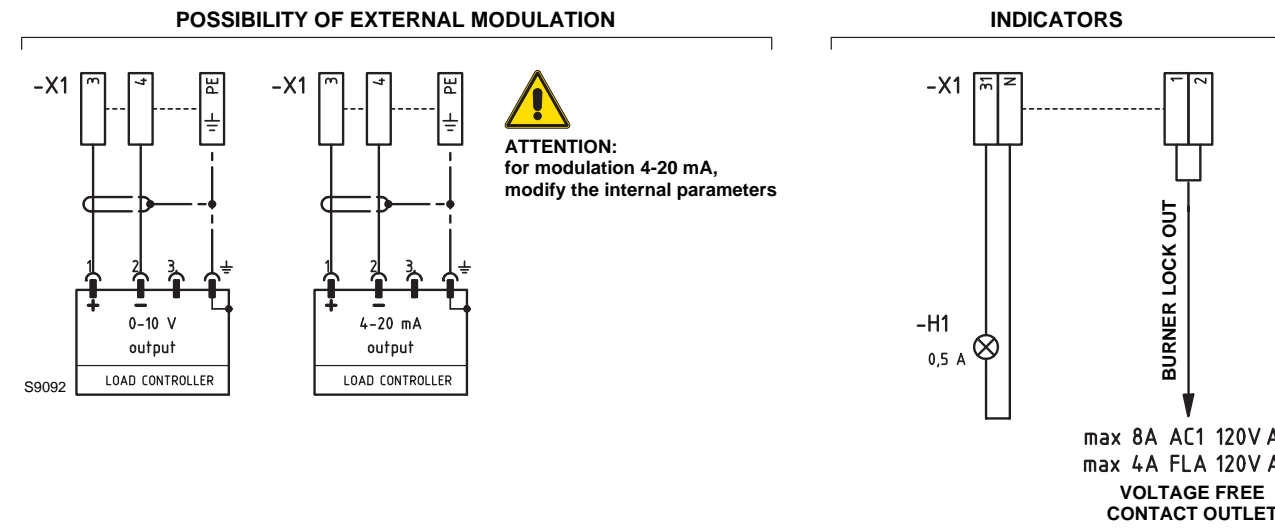

- Key (Fig. 19)
- H1 Remote lockout signal
 - PGMin Minimum gas pressure switch
 - Q1 Single phase disconnecting switch
 - TS Manual reset high limit control
 - X1 Burner terminal strip

Fig. 19

4.10.4 Opening sequence of the fuse-holder



DANGER

Disconnect the electrical supply from the burner by means of the main system switch.

In case of failure or control of the fuse-holder, follow these steps to remove or replace the fuse:

- unhook as indicated in Fig. 20;
- open the component side (check or replace) as indicated in Fig. 21;
- close the component side (Fig. 22);
- hook the component side (Fig. 23).



WARNING

After the installation, verify all the safety conditions: pipe-line leakage, draft, adequacy and stability of main flame at all allowable firing rates and sudden changes in firing rate, performance and gas tightness of all safety shut-off valves.



Cover plates, enclosures, and guards must be maintained in place at all times, except during maintenance and servicing.

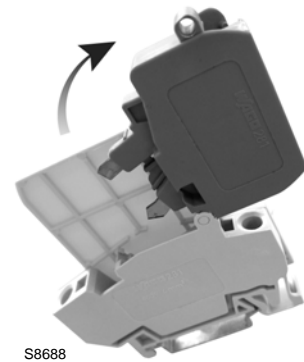

Fig. 20

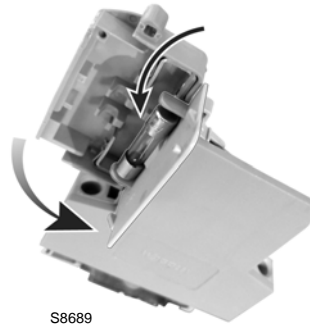

Fig. 21



Fig. 22

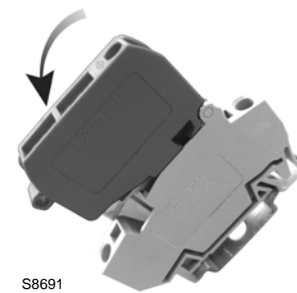

Fig. 23

5

Start-up, calibration and operation of the burner

5.1 Notes on safety for the first start-up



The first start-up of the burner must be carried out by qualified personnel, as indicated in this manual and in compliance with the standards and regulations of the laws in force.



Check the correct working of the adjustment, command and safety devices.

5.2 Adjustments before first firing

The following adjustments must be carried out:

- open the manual valves upline of the gas train;
- bleed the air from the gas pipes using the screw on the socket P1)(Fig. 15, page 22);

- adjust, if present, the min. gas pressure switch to the start of the scale.

5.3 Fan adjustment

Modulation is based on variable-speed technology.

Combustion air delivery can be adjusted by varying the motor's speed (rpm).

The proportioning gas train delivers the right amount of fuel, depending on the pressure detected in the purging circuit.

Hence the output delivered is adjusted by varying the motor's speed of rotation. The speed of the motor can be adjusted setting the control box.

The adjustments, via the on board operating panel (Fig. 24), are carried out by means of the positions:

- **START** (P0) parameter P403.00
Determines the ignition position
- **MIN** (P1) parameter P403.01
Determines the minimum modulation
- **MAX** (P2) parameter P403.02
Determines the maximum modulation

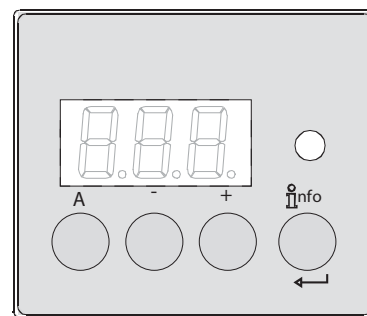

S8595

Fig. 24

5.4 Burner start-up

The burner can operate in two different modes:

- 1 manual operation (to be used for first start-up): in this mode the indicators of the display are blinking;
- 2 normal operation (for normal work operation): in this mode the indicators of the display are fixed;

5.4.1 First burner start-up (manual operation)

- Electric voltage is available (indicator light **POWER ON** must be on) (Fig. 25).
- Safety circuit closed.
- Turn the "ON/OFF" selector to "OFF", appliance in standby (OFF).
- Disconnect the external modulation control (control with 3 points or analogue signal).

- Keep the button "A" pressed together with the button "+" or "-" > 5 seconds.
- The display shows **OFF** blinking.

NOTE:

if no operation is carried out for a time of >30 seconds, LME7 passes automatically to the normal operation mode. The adjustment of the work points needs to be restarted.

- Turn the "ON/OFF" selector (Fig. 25) to "ON" and make sure that there is a heat request (thermostat on ON).
- LME7 starts and carries out a start-up. The corresponding phases of the program are carried out according to the sequence scheme and the program phases are displayed blinking.
- The appliance works up to the end of the P30 pre-purging phase, it is brought to the starting load and passes to the P0 display (ignition load rpm). The display passes from P0 to a three-digit number.

NOTE:

the three-digit number indicates the setting value for the parameter P0 / P1 or the parameter P2 as number of revs, and must be multiplied by 10.

- Pressing the button "A" and the button "+" or "-", it is possible to change the number of 10 rpm within pre-set limits (P0max, P0min).

NOTE:

the setting for the parameter P0 must be greater than the setting for the parameter P1. The values are checked by the LME7. If the setting rules are violated, the appliance goes into lockout mode, signalling a Loc error: 225.

- With the button "info" the setting value is confirmed in the internal memory.
- The burner proceeds with the ignition phase. If at the end of the safety time the flame does not appear, the burner restarts in automatic mode (it carries out a maximum of 3 attempts). The indications of the sequence of the phases on the display continue to blink to signal that we are still in the start-up procedure (manual operation). If the burner still does not fire, the problem may be that gas is not reaching the combustion head within the 3-second safety time. Turn the screw V1 of the gas valve lightly towards the "+" sign (Fig. 15, page 22).

NOTE:

To go back to manual mode it is necessary to turn the "ON/OFF" selector to "OFF" and repeat the procedure from the beginning (keep the buttons "A" and "+" or "-" pressed simultaneously > 5 seconds; the display shows OFF blinking.

If the selector stays on "ON" the burner restarts in normal operating mode (normally carries out all the stages of the ignition without stopping, to the end of the pre-purging time, at point P0).

- Turn the screw V1 towards the "+" sign (Fig. 15, page 22).
- The start-up proceeds. The burner is ignited, the program continues to the minimum load position P1. The display passes from P1 to the number of revolutions expressed with three digits.
- Pressing the button "A" and the button "+" or "-", it is possible to change the number of 10 rpm within pre-set limits (P1max, P1min).
- Check the appearance of the flame, if possible, or the value of the CO and CO2 to understand whether the burner has been sufficiently calibrated (first maximum calibration). If necessary use the screw V2 of the gas valve (turn towards the "+" sign to increase the gas, towards the "-" sign to decrease the gas) (Fig. 15, page 22).
- With the button "info" the setting value is confirmed in the internal memory.
- The burner proceeds to the maximum load position P2. The display passes from P2 to the number of revolutions expressed with three digits.

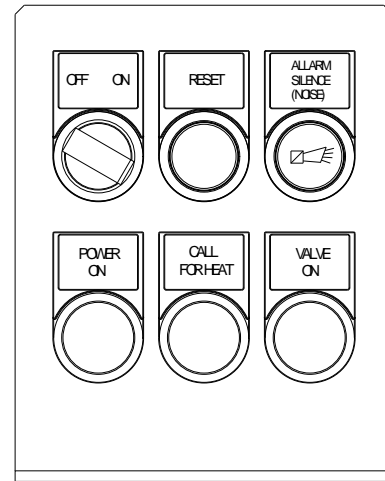

20056507

Fig. 25

Key (Fig. 25)

- "OFF/ON" switch
- "RESET" signal button
- "POWER ON" signal
- "CALL FOR HEAT" signal
- "ALARM NOISE" acoustic signal
- "ALARM SILENCE" button
- "VALVE ON" signal

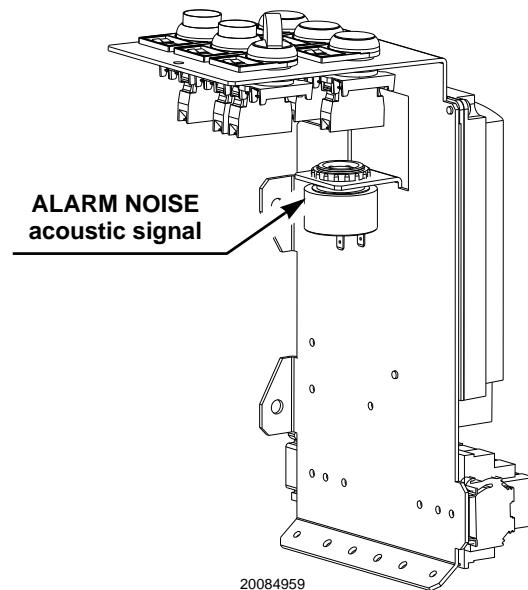

20084959

Fig. 26

- Pressing the button "A" and the button "+" or "-", it is possible to change the number of 10 rpm within pre-set limits (P2max, P2min).
- Check the appearance of the flame, if possible, or the value of the CO and CO2 to understand whether the burner has been sufficiently calibrated (first maximum calibration). If necessary use the screw V1 of the gas valve (turn towards the "+" sign to increase the gas, towards the "-" sign to decrease the gas) (Fig. 15, page 22).
- With the button "info" the setting value is confirmed in the internal memory.
- From here the speeds of the low flame P1 or the high flame P2 can be changed as described above, or else it is possible to end the setting procedure and put the burner in normal operating mode by pressing the button "ESC" (press "+" or "-" at the same time).
- Connect the external modulation control (control with 3 points or analogue signal). In the automatic operation position the output requisites of the external load regulator are valid.

NOTE:

to safeguard the settings on the PME7 program module, a manual backup must be carried out. See also the paragraph "Manual backup" on page 32.



WARNING

Eventual modifications to the parameters and the settings should be set and saved in the memory on-board the unit.

To save the modified settings of the PME7... program module, the backup should be activated manually. If this is not respected you risk losing the safety functions.



WARNING

At the first start-up, or else after replacing the program module, it is necessary to check, immediately after the reset process, the sequence of the functions and the settings of the parameters.

If this is not respected you risk losing the safety functions.



WARNING

If the parameters have been changed, you need to make a backup! If this is not respected you risk losing the safety functions.

5.4.2 Checking the modulating operation (automatic operation)



WARNING

Before setting the burner in modulating operation carry out the procedure "First burner start-up (manual operation)" at page 29..

- Close the thermostat and switch on the burner's power;
- Open manual gas valve;
- Light signal "POWER ON" must be switched on.
- Turn the selector "OFF/ON" on position "ON";
- Light signal "CALL FOR HEAT" must be switched on.
- Make sure that the external modulation control (control with 3 points or analogue signal) is connected and working correctly.

The burner starts up in pre-purging mode at maximum speed.

Subsequently, the START value speed decreases and start-up occurs. If the fan starts up but at the end of the safety time the flame does not appear, burner goes into lockout mode.

At the gas valve opening, the light signal "VALVE ON" must be switched on.

Reset and wait for a new start-up attempt.

If ignition continues to not occur, it may be the case that the gas is not arriving at the combustion head within the safety time of 3s.

Rotate the screw V1 (Fig. 15, page 22), located on the gas valve mixer, towards the "+" sign.

Once the burner has fired, proceed with the global adjustment of the burner.



NOTE:



when the burner is operating, the control box displays "oP:" means modulating operation. The display after "oP:" indicates the value as percentage of the speed. The speed corresponding to 100% is that of point P2 (maximum speed).

To calculate approximately the number of fan revolutions from the percentage "oP" it is necessary to multiply the speed set at point P2 by the percentage read (for example, with P2=6000rpm and oP =20% the speed of the fan is about 1200rpm).

If the speed set at point P2 is changed (to lower the burner output, for example) also the current value, equal to "oP", is changed (e.g. P2 = 5000 rpm e oP = 20% the fan speed is about 1000 rpm).



Manual backup

 and  simultaneously for >1 second (Escape) to start a manual backup process.
 Parameter **PrC** appears.
 Display: **PrC**
 >1 s

 or  for parameter **bAC**.
 Display: **bAC**

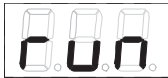
 1...3 s

 **Run** appears during download (backup process) of the program sequence.



 Alternately

Display shows alternately **End** and **bAC**.
 Display shows the end of data exchange.

Display appears for 2 minutes or can be finished by pressing 



When the backup process is completed, the display shows **OFF**.

  for >1 second to reset the unit.
 Display: **OFF**
 >1 s

Tab. P

If any parameters are changed, a backup must be made!

5.5 Burner shut down

Switch off power supply. If burner is switched off for extended periods, close manual gas cocks.



WARNING

Turning the "ON/OFF" switch to "OFF" position during the burner post-ventilation phase, the equipment shuts down after a few seconds (ERROR LOC:83).



WARNING

A vent shut off system shall be applied to a barometric damper installed in the venting system at the time of conversion of the appliance.

This will electrically disconnect the burner should there be a blockage in the vent (chimney).

The installer must identify the main electrical power switch and manual gas shut off valve, for emergency conditions. The burner cover must be in place and secured before the burner is placed in operation.

5.6 Gas valve adjustment

The adjustment of the output of gas is achieved by using the two screws V1 and V2 (Fig. 15, page 22).

To alter the maximum output of gas use screw V1:

- to increase the output: turn the screw towards the "+" sign;
- to reduce the output: turn the screw towards the "-" sign;

To alter the minimum output of gas act on the screw V2 on the gas valve.

Remove the protection screw and act on the intern screws with a hex key:

- to increase the output: turn the screw towards the "+" sign;
- to reduce the output: turn the screw towards the "-" sign;

5.7 Burner adjustment

The optimum adjustment of the burner requires an analysis of flue gases at the generator outlet. In conformity with the US and Canadian requirements, the burner application at the generator, the adjustment and the testing must be carried out in compliance with the instruction manual of the generator itself, including the control of the CO and CO₂ concentration in the flue gases and of their temperature (See Tab. G at page 10).

Check in sequence:

- max output
- min output
- ignition output

MAX output should match the value required by the boiler that is used. To raise or lower its value, adjust the parameter P2) using the operator panel of the control box (Fig. 24, page 29).

Measure the gas delivery on the meter to precisely establish the burnt output.

Using a combustion analyser, measure the value of the CO₂ or the O₂ in order to optimise the burner calibration. The correct values are: CO₂ 8.2 - 9%.

To correct these values act on the gas valve in the following way:

- to increase the gas delivery and the CO₂: turn the screw V1 towards the "+" sign;
- to reduce the gas delivery and the CO₂: turn the screw V1 towards the "-" sign.

MIN output should match the value required by the boiler that is used. To raise or lower its value, adjust the parameter P1) using the operator panel of the control box (Fig. 24, page 29).

Measure the gas delivery on the meter to precisely establish the burnt output.

Using a combustion analyser, measure the value of the CO₂ or the O₂ in order to optimise the burner calibration. The correct values are: CO₂ 7.8 - 8.5%.

To correct these values act on the gas valve in the following way:

- to increase the gas delivery and the CO₂: turn the screw V2 towards the "+" sign;
- to reduce the gas delivery and the CO₂: turn the screw V2 towards the "-" sign;

The **IGNITION output** can be found within area A highlighted in the firing rate (Fig. 4, page 10). To raise or lower its value, adjust the parameter P0) using the operator panel of the control box (Fig. 24, page 29).



WARNING

Do not change the valve adjustments.

5.7.1 Optimum calibration values

	MIN output		MAX output	
	CO ₂ (%)	O ₂ (%)	CO ₂ (%)	O ₂ (%)
Methane	8	6.6	8.5	5.7
LPG	9.5	6.4	10	5.6

Tab. Q

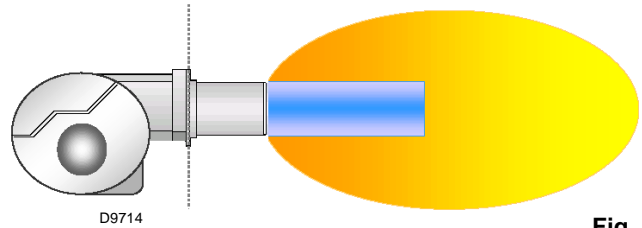

Fig. 27





5.8 Check of modulating operation





The burner leaves the factory set to 0-10 V signal for the modulating operation.





5.8.1 Display of preset output

Display is possible only when:

- in operating mode or standby,
- program sequence for modulating operation via analog preset output.



 Press  for display of the relative current position of the actuator.
 Signal lamp blinks green.
 Display shows **.0P**.



 Press  (1...3 seconds) for display of the relative current position.
 Signal lamp blinks green.
 The **relative** value **.57** of the current position is displayed.
 Example: value **.57**
PME7... with PWM fan:
 Current speed 0 rpm = 0% display
 Current speed corresponds to the rated load speed = 100% display



 When pressing  for >3 seconds, the point after the number begins to blink. When the button is released, the value is displayed for 2 minutes.
 Signal lamp blinks green.
 Then, the normal display appears.
 Display: value **57**, point **.** blinks

Tab. R

5.8.2 Load controller inputs

Selection source preset output analog/3-position step input (P654)

The following input signals can be selected and handled via parameter P654.

- 3-position step input (feedback potentiometer ASZxx.3x required/depending on the program sequence)
- 0...10 V
- 0...135 Ω
- 0...20 mA
- 4...20 mA with lockout at I < 4 mA (AZL2...: Loc: 60)
- 4...20 mA

6

Maintenance

6.1 Notes on safety for the maintenance

The periodic maintenance is essential for the good operation, safety, yield and duration of the burner.

It allows you to reduce consumption and polluting emissions and to keep the product in a reliable state over time.



DANGER

The maintenance interventions and the calibration of the burner must only be carried out by qualified, authorised personnel, in accordance with the contents of this manual and in compliance with the standards and regulations of current laws.

Before carrying out any maintenance, cleaning or checking operations:



DANGER

Disconnect the electrical supply from the burner by means of the main system switch.



DANGER

Close the fuel inlet connection.



Wait for the components in contact with heat sources to cool down completely.

6.2 Maintenance programme

6.2.1 Maintenance frequency



The gas combustion system should be checked at least once a year by a representative of the manufacturer or another specialised technician.

6.2.2 Checking and cleaning



The operator must use the required equipment during maintenance.

Combustion

The optimum calibration of the burner requires an analysis of the flue gases.

Significant differences with respect to the previous measurements indicate the points where most care should be exercised during maintenance.

Combustion head

Open the burner and make sure that all components of the combustion head are in good condition, not deformed by the high temperatures, free of impurities from the surroundings and correctly positioned.

Burner

Check that there are not excess wear or loosen screws.
Clean the outside of the burner.

Fan

Check to make sure that no dust has accumulated inside the fan or on its blades, as this condition will cause a reduction in the air flow rate and provoke polluting combustion.

Electrical Wiring

Check that the burner and gas train electrical connections are correct.

Boiler

Clean the boiler as indicated in its accompanying instructions in order to maintain all the original combustion characteristics intact, especially the flue gas temperature and combustion chamber pressure.

Gas leaks

Make sure that there are no gas leaks in the following areas:

- on the meter-burner pipework
- on the mixer/valve connection
- on the burner fastening flange where the seal is fitted.

Electrode unit

Make sure neither the electrodes nor probe feature marked warping or oxidation on surfaces. Make sure distances are still in line with those indicated in this manual, readjusting to the right values where necessary. Where necessary, remove oxide from the surface of the probe with abrasive paper.

Gas train

Check valve setting and proportionality of operation by analysing flue gases. Check the valve/manifold compensation pipe.

Gas filter

Change the gas filter when it is dirty.

Combustion

In case the combustion values found at the beginning of the intervention do not respect the standards in force or, in any case, do not correspond to a proper combustion, contact the Technical Assistant in order to carry out the necessary adjustments.

NOx expected emissions on natural gas (expressed in ppm@3% O₂)

Sub 30		Sub 20		Sub 9	
CO ₂ (%)	O ₂ (%)	CO ₂ (%)	O ₂ (%)	CO ₂ (%)	O ₂ (%)
8.5 ~ 8.75	5.8 ~ 5.4	8.0 ~ 8.5	6.7 ~ 5.8	7.25 ~ 7.75	8.0 ~ 7.1

Tab. S

6.2.3 Measuring circuit for detector current measurement



Simultaneous operation of QRA... and ionization probe is not permitted!
If not observed, there is a risk of impairment of safety functions.

The minimum current necessary for the control box operation is 1 µA. The burner normally supplies a higher current value, so that no check is needed.

Anyway, if you want to measure the ionisation current, you need to open the connector (CN1) fitted on the red wire and insert a microammeter.

Check of signal flame

Display value:

MIN 1 µA = 20%

MAX 40 µA = 100%



This display is only possible in operating mode or standby!

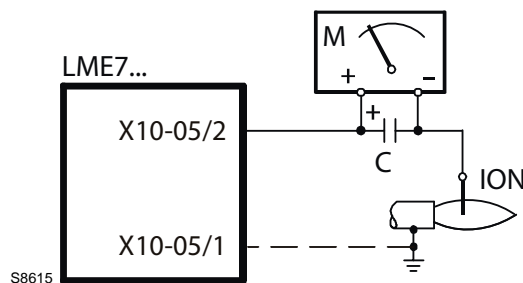

Fig. 28

Key (Fig. 28)

C Electrolytic condenser 100...470 µF; DC 10...25 V

ION Ionization probe

M Microammeter Ri max. 5,000 Ω

Display of flame current ION or QRA...



Press for display of the flame signal amplifier.
Signal lamp blinks green.
Display shows **FL.1**

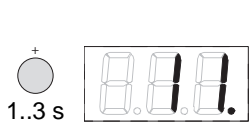

Press (1...3 seconds), the flame signal current is displayed.
Signal lamp blinks green.
Example: **11**

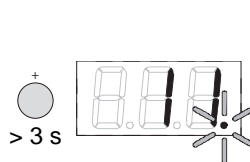

When pressing (>3 seconds), the point after the number begins to blink.
When the button is released, the value is displayed for 2 minutes.
Signal lamp blinks green.
Then, the normal display appears.
Display: Point . blinks,
value **11** does not.

Tab. T

6.3 Safety components

The safety components must be replaced according to the limit of the lifetime cycles indicated in the Tab. U.

The lifetime cycles specified, are not referred to the warranty time indicated in the delivery and payment conditions.

Safety component	Lifetime cycle
Control box	10 years or 250,000 operating cycles
Flame sensor	10 years or 250,000 operating cycles
Solenoid valves	10 years or 250,000 operating cycles
Pressure switches	10 years or 250,000 operating cycles
Gas pressure regulator	15 years
Servomotors (electronic cam)	10 years or 250,000 operating cycles
Solenoid oil valves	10 years or 250,000 operating cycles
Oil regulator	10 years or 250,000 operating cycles
Fuel pipes/ connectors (metallic)	10 years
Hoses	5 years or 30,000 pressure cycles
Fan wheel	10 years or 500,000 startings

Tab. U

6.4 Recommended preventive maintenance schedule

Operation and maintenance instructions are intended for general applications. For specific operating and maintenance instructions, consult the equipment manufacturer.

Test/Inspection	Frequency
Check gages, monitors, and indicators	DAILY
Check instrument and equipment settings	DAILY
Check burner flame	DAILY
Check igniter	WEEKLY
Check flame signal strength	WEEKLY
Check flame failure detection system	WEEKLY
Check firing rate control	WEEKLY
Make aural and visual check of pilot and main fuel valves	WEEKLY
Check flue, vent, stack, or outlet dampers	MONTHLY
Test low draft, fan air pressure, and damper position interlocks	MONTHLY
Check low-fire start interlock	MONTHLY
Test high and low gas pressure interlocks	MONTHLY
Recalibrate all indicating and recording gages	SEMI-ANNUALLY
Check flame failure detection system components	SEMI-ANNUALLY
Check firing rate control	SEMI-ANNUALLY
Check piping and wiring of all interlocks and shutoff valves	SEMI-ANNUALLY
Inspect burner components	SEMI-ANNUALLY
Flame failure detection system, test for hot refractory hold-in	ANNUALLY
Replace flame rod in accordance with manufacturer's instructions	ANNUALLY
Conduct a combustion test	ANNUALLY
Check all coils and diaphragms; test other operating parts of all safety shutoff and control valves	ANNUALLY
Test fuel valve interlock switch in accordance with manufacturer's instructions	ANNUALLY

Test/Inspection	Frequency
Perform leakage test on pilot and main gas valves	ANNUALLY
Test purge air switch in accordance with manufacturer's instructions	ANNUALLY
Test low-fire start interlock in accordance with manufacturer's instructions	ANNUALLY
For gas-fired burners, check sediment trap and gas strainers	AS REQUIRED
Flame failure detection system, test for hot refractory hold in	AS REQUIRED

Tab. V

6.5 Opening and closing the burner



DANGER

Disconnect the electrical supply from the burner by means of the main system switch;.



DANGER

Close the fuel inlet connection.



Wait for the components in contact with heat sources to cool down completely.



After carrying out maintenance, cleaning or checking operations, reassemble the cover and all the safety and protection devices of the burner.

7 Operation, indication, diagnostics

7.1 Control sequence in the event of fault

If lockout occurs, the outputs for the fuel valves, the burner motor and the ignition equipment are immediately deactivated (<1 second).

Cause	Response
Mains voltage failure	Restart
Voltage below undervoltage threshold	Safety shutdown
Voltage above undervoltage threshold	Restart
Extraneous light before safety time	Lockout
Extraneous light during waiting time	Start prevention, lockout after approx. 30 seconds at the latest
No flame at the end of safety time	Lockout end of safety time
Loss of flame during operation	Factory setting: lockout Can be parameterized: (depending on program module 1 x repetition)
Pressure switch-min: failure during operation	Shutdown and start prevention

Tab. W

In the event of lockout, the LME71... remains locked and the red fault signal lamp lights up. The burner control can immediately be reset. This state is also maintained in the event of mains failure.

7.2 Fault status messages, display of errors

7.2.1 Display of errors (faults) with lockout



Alternately

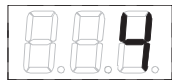

Display shows alternately **Loc** and **4**.

Unit is in the lockout position.

- The current error code is displayed and the signal lamp is blinking red.
Example: error code **4**

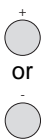

- Press or for display of the phase, where the fault appeared.
Signal lamp blinks red.
Example: phase **P02**

Only with modulation via analog signal



- Press for display of the output position/actuator position where the error occurred.
Signal lamp lights up red.
Example: output position/actuator position **49**.

Tab. X

7.3 Error code list with operation via internal LED

Error code	Clear text	Possible cause
bAC Er3	Fault of compatibility program module to basic unit during backup process	Program sequence of program module does not match the basic unit
Err PrC	Fault of program module	<ul style="list-style-type: none"> – Error in data content of program module – No program module fitted
Loc 2	No establishment of flame at the end of the safety time	<ul style="list-style-type: none"> – Faulty or soiled fuel valves – Faulty or soiled flame detector – Poor adjustment of burner, no fuel – Faulty ignition equipment
Loc 4	Extraneous light	– Extraneous light when burner startup
Loc 6	Fault of actuator	<ul style="list-style-type: none"> – Actuator faulty or blocked – Faulty connection – Wrong adjustment
Loc 7	Loss of flame Too many losses of flame during operation (limitation of repetitions)	<ul style="list-style-type: none"> – Faulty or soiled fuel valves – Faulty or soiled flame detector – Poor adjustment of burner
Loc 8	---	Free
Loc 9	---	Free
Loc 10	Error not relatable (application), internal error	Wiring error or internal error, output contacts, other faults
Loc 12	Valve proving	Fuel valve 1 leak
Loc 13	Valve proving	Fuel valve 2 leak
Loc 14	POC error	Error valve closure control POC
Loc 20	Gas pressure switch min open	Gas shortage
Loc 22	Safety loop open	<ul style="list-style-type: none"> – Gas pressure switch-max open – Safety limit thermostat cut out
Loc 60	Analog power source 4...20 mA, I < 4 mA	Wire breakage
Loc: 83	Faulty PWM fan	<ul style="list-style-type: none"> – PWM fan does not reach the target speed within the pre-set period of time, or – After reaching the target speed, the PWM fan leaves the tolerance band again (P650) for a time exceeding the tolerance time speed deviation (P660)
Loc 138	Restore process successful	Restore process successful
Loc 139	No program module detected	No program module identified
Loc 167	Manual locking	Manual locking
Loc: 206	AZL2... incompatible	Use the latest version
Loc: 225	Faulty PWM fan	<ul style="list-style-type: none"> – Fan speed dropped below the minimum prepurge PWM (P675.00) after reaching the prepurge speed, or – After reaching the ignition load speed, the maximum ignition load PWM (P675.01) was exceeded
Loc: 226	Faulty PWM fan	Parameterization error: <ul style="list-style-type: none"> – Speed low-fire > speed high-fire, or – Low-fire = 0 rpm, or – Maximum speed = 0 rpm
Loc: 227	Faulty PWM fan	One or several parameters violate the minimum/maximum limit
rSt Er1	Error in compatibility program module to basic unit during restore process	Program sequence of program module does not match the basic unit
rSt Er2	Error in compatibility program module to basic unit during restore process	Hardware of basic unit does not match the program module
rSt Er3	Error during the restore process	<ul style="list-style-type: none"> – Program module faulty – Program module removed during restore process

Tab. Y

7.4 Resetting the burner control

When lockout occurs, the burner control can immediately be reset.

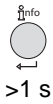

For reset the unit, press  for 1...3 seconds. When the button is released, **OFF** is displayed.

The basic unit is reset.

The LME71... can only be reset when all contacts in the line are closed and when there is no undervoltage.

Tab. Z

NOTE:

For meaning of the error and diagnostic codes, see chapter "Error code list with operation via internal LED" at page 40.

7.5 Operation



The lockout reset button (info button) is the key operating element for resetting the burner control and for activating/deactivating the diagnostics functions.

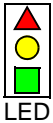

The multicolor signal lamp is the key indicating element for visual diagnostics.

Both lockout reset button and signal lamp are located in the control panel.

There are 2 diagnostics choices:

- 1 Visual diagnostics: Indication of operating state or diagnostics of cause of fault.
- 2 Diagnostics: via BCI to AZL2... display and operating unit.

Visual diagnostics:

In normal operation, the different operating states are indicated in the form of color codes according to the color code Tab. M, page 16.

7.5.1 Manual adjustment

Display is possible only when:

- in operating mode or standby,
- program sequence for modulating operation via analog preset output and with connected actuator with potentiometer for position feedback to the LME7...



Press  for the relative current position of the actuator or the relative current speed of the PWM fan. Signal lamp blinks green. Display shows **.oP**.



Press  (1...3 seconds) for display of the relative current position or the current speed. Signal lamp blinks green. The **relative** value **.57** of the current position is displayed.

Actual speed
0 rpm = 0% display
Current speed corresponds to the rated load speed = 100% display
Example: value **.57**



When pressing  for >3 seconds, the point after the number begins to blink. When the button is released, the value is displayed for 2 minutes.

Signal lamp blinks green. Then, the normal display appears. Display: value **57**, point . blinks





 > 3 s

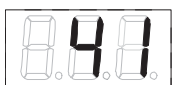

 Alternately







Press  for >3 seconds to display alternately LoA and 41.
 The **relative** value **41** of the current position or current speed is displayed.
 Current speed 0 rpm = 0% display
 Current speed corresponds to the rated load speed = 100% display.
 The actual value (example **41%**) is displayed and the signal lamp blinks green.
 Example:
 Position of actuator or the current speed **41%** (based on range between high-fire and 0° or 0 rpm).





 and

or





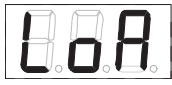

Press  simultaneously with  or  to adjust the fan speed between low-fire (x%) and high-fire (100%).
 Release the buttons when the required position or speed is reached. Signal lamp blinks s green.
 Example: value **43**



 Alternately







Display shows alternately **LoA** and **43**.
 Signal lamp blinks green.
 Example: Required position of actuator or current speed **43%**

and





Press  and  simultaneously (Escape) to return to normal operation.
 Display: **oP**
 When manual adjustment is completed, the actuator or the PWM fan returns to the analog preset output!

Tab. AA

NOTE:

- When the program phase (e.g. P10 - shut-down) changes during manual adjustment, the display blinks
- Manual adjustment mode remains active until Escape switches the basic unit back to normal operation or until the basic unit is reset via mains ON/OFF. This means that in the case of a new heat request and after start-up, the actuator or the PWM fan is driven to the position or speed of the manually pre-set value.

7.5.2 Diagnostics of cause of fault

After lockout, the red fault signal lamp remains steady on. In that condition, visual diagnostics of cause of fault according to the error code table can be activated by pressing the lockout reset button (info button) for more than 3 seconds.

Pressing the lockout reset button (info button) again for at least 3 seconds, interface diagnostics will be activated.

If, by accident, interface diagnostics has been activated, in which case the slightly red light of the signal lamp flickers, it can be deactivated by pressing again the lockout reset button (info button) for > 3 seconds.

The instant of switching over is indicated by a yellow light pulse.

Error code table

Red blink code of fault signal lamp	Possible cause
2 x blinks	No establishment of flame at the end of the safety time – Faulty or soiled fuel valves – Faulty or soiled flame detector – Poor adjustment of burner, no fuel – Faulty ignition equipment
4 x blinks	Extraneous light on burner startup
6 x blinks	Actuator position not reached – Actuator faulty – Actuator defective or blocked – False connection – Misadjustment
7 x blinks	Too many losses of flame during operation (limitation of repetitions) – Faulty or soiled fuel valves – Faulty or soiled flame detector – Poor adjustment of burner
8 x blinks	Free
9 x blinks	Free
10 x blinks	Wiring error or internal error, output contacts, other faults
12 x blinks	Valve proving – Fuel valve 1 leaking
13 x blinks	Valve proving – Fuel valve 2 leaking
14 x blinks	Error in connection with valve closure control POC
15 x blinks	Error code ≥ 15 (e.g. depending on type of program module) Error code 20: Failure of gas pressure switch-min Error code 22: Error of safety loop

Tab. AB

During the time the cause of fault is diagnosed, the control outputs are deactivated

- Burner remains shut down
- External fault indication (alarm) at terminal X2-03, pin 3 steady on

Diagnostics of cause of fault is quit and the burner switched on again by resetting the burner control.

Press the lockout reset button (info button) for about 1 second (< 3 seconds).

7.5.3 First startup with a new program module or in case of replacement of program module



Alternately



- Display shows alternately **rSt** and **PrC**.
- Display shows the replacement of the program module.
- Signal lamp blinks red once and yellow twice alternately.

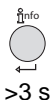

Press for >3 seconds to start data download from the program module. Signal lamp blinks yellow.

- The process of 3 seconds is supported by a short flash of the yellow signal lamp.

Note: If you press for <3 seconds, data download does not start. To start the restore process again, the LME7... must be reset by switching mains ON/OFF.



Display shows run during download (restore process) of the program sequence.



Alternately



- Display shows alternately **End** and **rSt**.
- Display shows the end of data exchange.

After 2 minutes, the unit changes to **Loc 138**



Alternately



- After the restore process, the unit is automatically in the lockout position (LOC 138) and must be reset for operation!

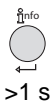

Press for >1 second to reset the unit.

Display: **OFF**



Tab. AC





WARNING

On first startup or after exchange of the program module, the sequence of functions and parameter settings must be checked upon completion of the restore process.

7.6 Manual restore

 and 
 > 1s





Press  and  simultaneously for >1 second (Escape) for starting the manual restore process. Parameter **PrC** appears.
 Display: **PrC**

 or 



Press  and  for parameter **rSt**.
 Display: **rSt**

 1...3s



run appears during download (restore process) of program sequence.



Alternately



After the restore process, the unit is automatically in the lockout position (LOC 138) and must be reset for operation!

After 2 minutes, the unit changes to **Loc 138**





Alternately



After the restore process, the unit is automatically in the lockout position (LOC 138) and must be reset for operation!

 > 1 s



Press  for >1 second to reset the unit.
 Display: **OFF**

Tab. AD

7.6.1 Errors during the restore process



Alternately with



or



or



Display shows alternately **rSt** and **Er1**, **Er2** or **Er3**.

For meaning of a possible cause, see chapter “**Error code list with operation via internal LED**” at page 40.

Tab. AE

NOTE:

During the restore process, all settings and parameters are written from the program module to the basic unit’s onboard memory. In the process, it is possible that previous program sequences, parameters and settings in the onboard memory will be overwritten!

7.6.2 Reset



When pressing  for 1...3 seconds, OFF is displayed.
When the button is released, the basic unit is reset.

Tab. AF

NOTE:

For meaning of the error and diagnostic codes, see chapter “**Error code list with operation via internal LED**” at page 40.

A

Appendix - Spare parts

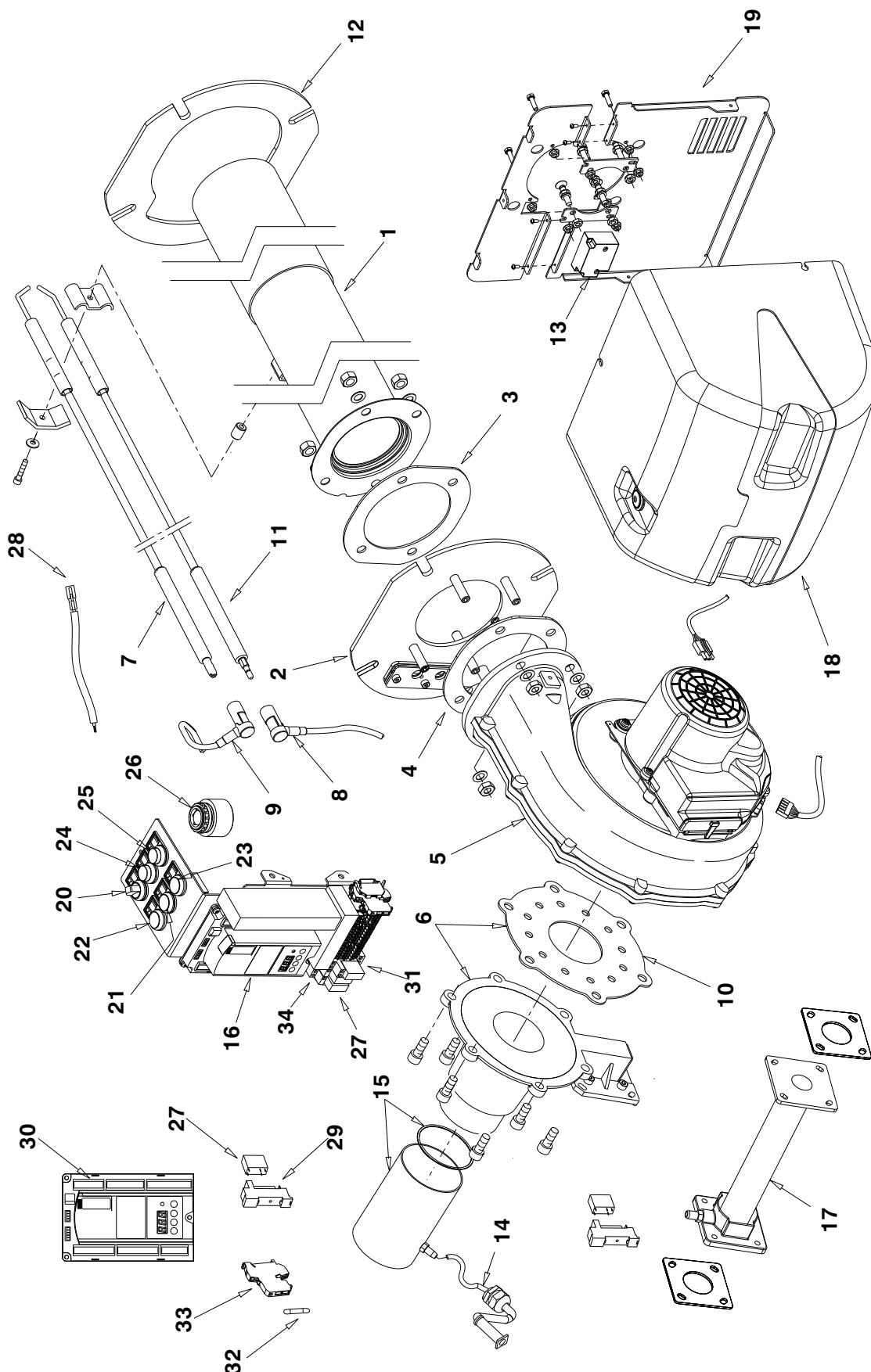

N.	CODE	20048844	20121231	DESCRIPTION	*
1	20061364	•		COMBUSTION HEAD	B
1	20138294		•	COMBUSTION HEAD	B
2	20061376	•	•	FLANGE	C
3	20061423	•	•	SEAL	C
4	20057928	•	•	SEAL	C
5	20057926	•	•	VENTILATION UNIT	C
6	3020431	•	•	VENTURI	C
7	20061431	•		ELECTRODE ASSEMBLY	A
7	20138296		•	ELECTRODE ASSEMBLY	A
8	20057929	•	•	PROBE CONNECTION	
9	3020478	•	•	HIGH VOLTAGE LEAD	
10	20057930	•	•	SEAL	C
11	20061430	•		PROBE	C
11	20138301		•	PROBE	C
12	20061436	•	•	GASKET	
13	20061505	•	•	TRASFORMER	B
14	20057933	•	•	TUBE	
15	20037534	•	•	COLLECTOR	
16	20052441	•	•	CONTROL BOX	B
17	20057934	•	•	GAS PIPE	A
18	20057935	•	•	COVER	B
19	20037547	•	•	FRONT PIECE ASSEMBLY	
20	20027021	•	•	SELECTOR SWITCH	
21	20036019	•	•	WHITE SIGNAL LIGHT	
22	20036017	•	•	GREEN SIGNAL LIGHT	
23	20027020	•	•	YELLOW SIGNAL LIGHT	
24	3013354	•	•	SIGNAL BUTTON	
25	20010962	•	•	BUTTON	
26	20031413	•	•	HORN	
27	3020068	•	•	RELAY	C
28	20122099	•	•	PROBE CONNECTION	A
29	3020071	•	•	BASE	
30	20123734	•	•	CONNECTORS ASSEMBLY	B
31	3020128	•	•	BASE + RELAY	C
32	20090369	•	•	FUSE	
33	20079389	•	•	FUSE HOLDER	A

*

ADVISED PARTS

A = Spare parts for minimum fittings

A+B = Spare parts for basic safety fittings

A+B+C = Spare parts for extended safety fittings

B**Appendix - Accessories****Interface kit****OCI410 interface for ACS410 software**

Interface between burner control and PC. Facilitates viewing, handling and recording setting parameters on site in connection with the ACS410 software.



The installer is responsible for the addition of any safety device not foreseen in this manual.

Burner	Code
RX 150 S/PV	20096826

Display kit

Burner	Code
RX 150 S/PV	20109292

C**Appendix - Burner start up report**

Model number:	Serial number:
Project name:	Start-up date:
Installing contractor:	Phone number:

Model number:	Serial number:
Project name:	Start-up date:
Installing contractor:	Phone number:

GAS OPERATION

Gas Supply Pressure:	CO ₂ : Low Fire	High Fire
Main Power Supply:	O ₂ : Low Fire	High Fire
Control Power Supply:	CO: Low Fire	High Fire
Burner Firing Rate:	NO _x : Low Fire	High Fire
Manifold Pressure:	Net Stack Temp - Low Fire:	High Fire
Pilot Flame Signal:	Comb. Efficiency - Low Fire:	High Fire
Low Fire Flame Signal:	Overfire Draft:	
High Fire Flame Signal:		

CONTROL SETTINGS

Operating Setpoint:	Low Oil Pressure:
High Limit Setpoint:	High Oil Pressure:
Low Gas Pressure:	Flame Safeguard Model Number:
High Gas Pressure:	Modulating Signal Type:

NOTES

RIELLO

RIELLO S.p.A.
I-37045 Legnago (VR)
Tel.: +39.0442.630111
[http:// www.riello.com](http://www.riello.com)

RIELLO

35 Pond Park Road
Hingham, Massachusetts,
U.S.A. 02043

RIELLO BURNERS NORTH AMERICA
<http://www.riello.ca>

1-800-4-RIELLO

2165 Meadowpine Blvd
Mississauga, Ontario
Canada L5N 6H6