

INSIEME EV0e 25 LN

EN USER MANUAL

RIELLO

Dear Customer,

Thank you for preferring a **RIELLO** heating unit, a modern, high-quality product that is able to guarantee your maximum well-being for a long period of time, with high levels of reliability and safety. In particular, if working together with a Technical Assistance Service **RIELLO** that is specifically prepared and trained to perform periodic maintenance, your unit will remain at maximum efficiency levels at minimum operating costs and if required, replacements with original spare parts can be made. This instruction manual contains important instructions and precautions that must be observed to ensure the trouble-free installation and efficient functioning of your **INSIEME EVOe 25 LN** boiler.

Please accept our renewed thanks for your purchase
Riello S.p.A.

CONFORMITY

INSIEME EVOe 25 LN boilers conform to the following directives:

- Directive 92/42/EEC on efficiency requirements
- Electromagnetic Compatibility Directive 2014/30/EU
- Low Voltage Directive 2014/35/EU
- Ecodesign Directive 2009/125/CE for energy-related products
- Regulation (EU) 2017/1369 Energy labelling
- Delegated Regulation (EU) N. 811/2013
- Delegated Regulation (EU) N. 813/2013
- Delegated Regulation (EU) N. 814/2013

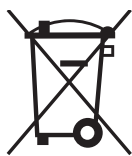

At the end of its life, the product should be not be disposed of as solid urban waste, but rather it should be handed over to a differentiated waste collection centre.

CONTENTS

1	GENERAL INFORMATION	4
1.1	General Safety Information	4
1.2	Precautions	4
1.3	Description of the appliance	5
1.4	Safety and control devices	5
1.5	System layout	6
1.6	Control panel	7
1.7	Menu navigation	9
1.8	Navigation scheme	11
1.9	List of user parameters	12
2	USE	14
2.1	Putting into service	14
2.1.1	Preliminary operations	14
2.1.2	Start-up	14
2.1.3	Adjustment of heating setpoint	15
2.1.4	Enable/disable the heating function	15
2.1.5	Enable/disable the domestic function	15
2.1.6	Adjustment of domestic setpoint	15
2.1.7	Special functions	16
2.1.8	Ignition failure	16
2.2	Temporary or short-term shut-down	17
2.3	Preparing for extended periods of disuse	17
2.4	Device cleaning and maintenance	17
2.5	External cleaning	17
2.6	Annual cleaning	17
2.7	Troubleshooting	18
3	RECYCLING AND DISPOSAL	18









The following symbols are used in this manual:

 **CAUTION!** = Identifies actions that require caution and adequate preparation.

 **STOP!** = Identifies actions that you **MUST NOT** do.











1 GENERAL INFORMATION

1.1 General Safety Information

-  This product must be installed by a legally qualified heating engineer. On completion of the installation, the installer must issue the owner with a declaration of conformity confirming that the installation has been completed to the highest standards in compliance with the instructions provided by **RIELLO** in this instruction manual, and that it conforms to all applicable laws and standards.
-  This product must only be used for the purpose for which it is designed and made, as specified by **RIELLO**. **RIELLO** declines all responsibility, contractual or other, for damage to property or injury to persons or animals caused by improper installation, adjustment, maintenance or use.
-  The room where the boiler is installed must be properly ventilated to ensure a sufficient supply of air for correct combustion.
-  If you notice any water leaks, disconnect the boiler from the mains electricity supply and shut off the water supply.
-  In case of water leaks disconnect the equipment from the power mains, close the water supply and promptly alert Technical Assistance Service **RIELLO** or professionally qualified personnel.
-  The boiler must be serviced at least once a year. The failure to perform annual maintenance work will void the warranty of the equipment.
-  Periodically check that pressure in the central heating circuit, when cold, is approximately 1.5 bar and below the maximum limit specified for the boiler. If this is not the case, contact the Technical Assistance Service **RIELLO** or professionally qualified personnel.
-  If the boiler is not going to be used for an extended period of time, perform the operations described later in this manual.
-  This manual is an integral part of the equipment and therefore must be stored carefully and must ALWAYS accompany the boiler even if it is sold to another Owner or User or transferred to another plant. If it is damaged or lost, request another copy from your local Technical Assistance Service **RIELLO**.

1.2 Precautions

The operation of any appliance that uses fuel, electrical power and water demands that a number of fundamental safety precautions be respected:

-  Do not allow children or infirm persons to operate the system unsupervised.
-  It is forbidden to use electrical devices or equipment, such as switches, appliances, etc. if there is a smell of gas or unburnt products. If so:
 - Ventilate the room, opening doors and windows
 - Close the fuel shut-off cock
 - Ask for the prompt intervention of the Technical Assistance Service
-  Do not touch the boiler while barefoot or wet.
-  Never pull, disconnect, or twist the electrical cables coming from the appliance even if it is disconnected from the mains electricity supply.
-  Do not obstruct or restrict the vents in the room where the boiler is installed. Adequate ventilation is essential for correct combustion.
-  Do not expose the boiler to the elements. It is not designed for use outdoors.
-  It is prohibited to leave inflammable substances and containers in the room where the boiler is installed.
-  Do not dispose of packaging material into the environment, or leave it within the reach of children, since it can become a potential hazard. Dispose of packaging material in compliance with applicable legislation.
-  It is forbidden to operate the boiler without water.
-  The equipment casing must not be removed by people without specific qualification and expertise.

1.3 Description of the appliance

The thermal unit **INSIEME EVOe 25 LN** is a hot water generator for the heating of environments. It can function at low temperature and is oil fuelled. The low NOx burner features a single-stage operation and a vertical steel combustion chamber. The boiler unit is effectively and accurately insulated with a high-density glass wool mat. The control panel includes a user interface with display and an electronic board for the thermal unit adjustment and control, which allows to manage the control and safety devices in compliance with the regulations in force.

1.4 Safety and control devices

The control panel, apart from managing the functions of the thermal unit **INSIEME EVOe 25 LN**, allows to highlight any anomaly which may affect its correct operation, ensuring the thermal unit safety by stopping it and automatically closing the burner light oil valve.

The burner control and adjustment board is also used to ensure the burner safety by managing its correct operation.

Any anomaly which may affect the generator operation forces it to stop (lock-out) and is promptly signalled with a numerical error code on the regulator display.

The following are installed on the water circuit:

- **Safety thermostat:** fitted on the generator body, it intervenes by stopping (permanent error) the thermal unit if the boiler temperature exceeds the limit threshold of 110°C;
- **Safety valve:** intervenes if the boiler pressure exceeds the limit threshold of 3 bar;
- **Pressure transducer:** sends a signal to the electronic regulator which views and continually checks the primary circuit pressure to switch on the generator or cause it to stop in case of low pressure;
- **Boiler temperature probes (delivery and return):** immersion probe on the delivery line of the generator is used by the regulator to view and check the delivery water temperature and check the correct switching on and off of the burner based on the programmed setpoint. The regulator uses the same probe to switch off the generator in case of overtemperature, before the triggering of the safety thermostat. The contact probe placed on the return line of the boiler is used by the regulator to view the return water temperature with which it calculates, together with the delivery temperature, the temperature difference between delivery and return (Δt), which allows regulating the modulation of the circulator in heating mode.

 The intervention of a safety device indicates a potentially dangerous malfunction in the system. Contact the manufacturer's Technical Assistance Service immediately.

 Safety devices must only be replaced by the manufacturer's Technical Assistance Service using original spare parts. Refer to the spare parts catalogue supplied with the boiler. After making the repair, check that the appliance is working properly.

 The appliance must not be put in service, even temporarily, when tampered safety devices are not in operation or have been tampered with.

1.5 System layout

INSIEME EVOe 25 LN

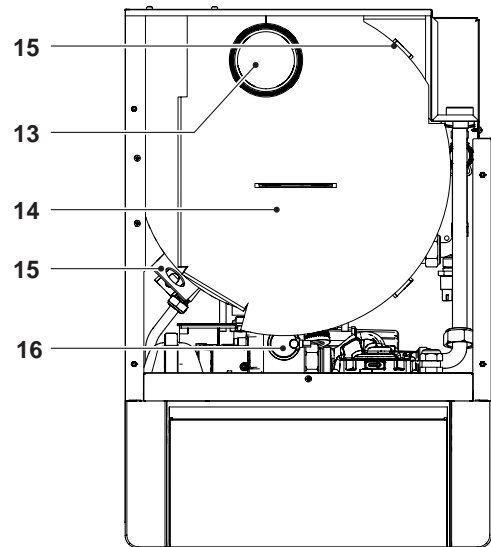
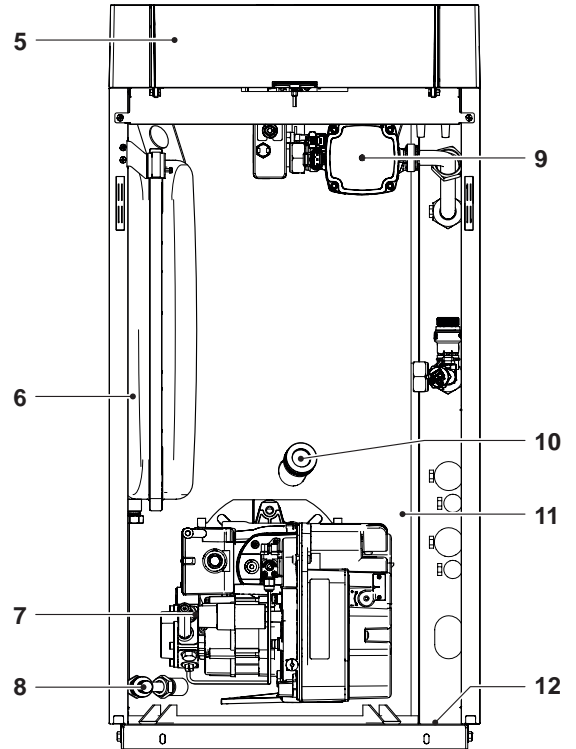
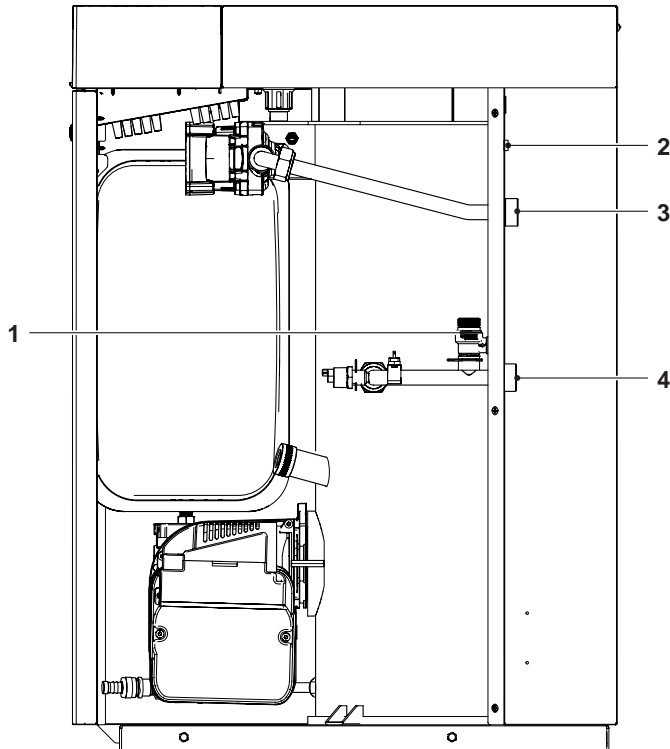

- 1 Safety valve
- 2 Main switch
- 3 Central heating flow
- 4 Central heating return
- 5 Control panel
- 6 Heating expansion reservoir
- 7 Burner
- 8 Drain cock
- 9 Pump
- 10 Flame inspection window
- 11 Boiler body
- 12 Serial number plate
- 13 Exhaust flue duct
- 14 Flue gas box cover
- 15 Lifting bracket
- 16 Automatic vent valve

1.6 Control panel

Controls interface

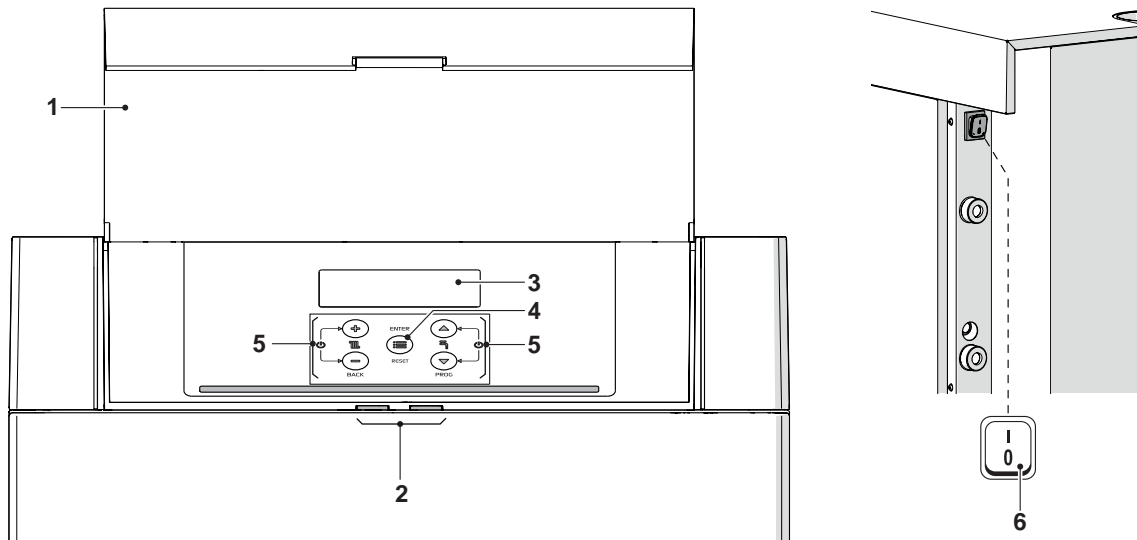

- 1 Door
- 2 Light guide
- 3 Rear light display
- 4 ENTER/RESET key: it allows accessing the main menu and restoring the operation after a stop due to an anomaly
- 5 Navigation keys
- 6 Main switch (located on the equipment rear wall)

Light Guide displaying

STATUS	DESCRIPTION
Green blinking	Thermal unit drain cycle and initialization in progress after the power supply reset.
Steady green	Thermal unit on
Steady red	Thermal unit in alarm mode
Red blinking	Thermal unit in lock-out mode

Display visualisation

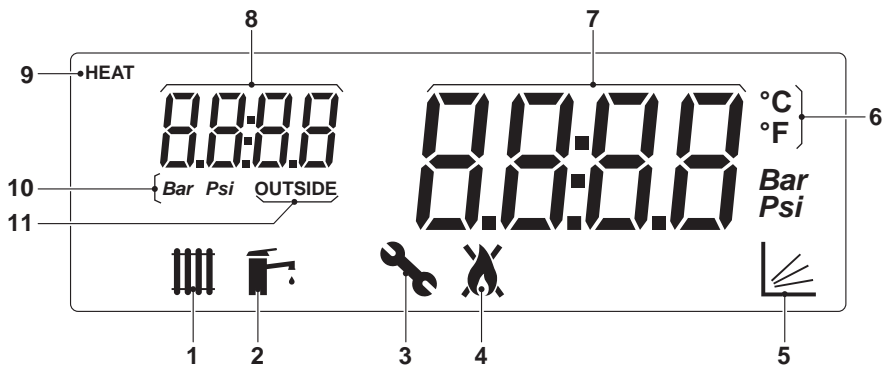

- 1 Icon displayed when heating mode is enabled. Blinking when there is a heat demand
- 2 Icon displayed when DHW mode is enabled. Blinking when there is an DHW Demand
- 3 Icon displayed when entering the "Installer" menu
- 4 Icon displayed when the burner of the equipment is on. The icon will be marked with a cross in case of Permanent or Temporary error.
- 5 Icon displayed when the climatic mode operation is active (Par. 2001= 1 or 2)
- 6 Celsius/Fahrenheit temperature
- 7 Displays current value
- 8 Displaying of system pressure or parameter number or external temperature
- 9 Icon displayed when the circulator is operating
- 10 Pressure in Bar/Psi
- 11 Icon displayed when the outdoor probe is connected

1.7 Menu navigation

At start-up or when no key is pressed for more than 4 minutes, the display is in "basic display" mode and provides general information on the equipment operation.

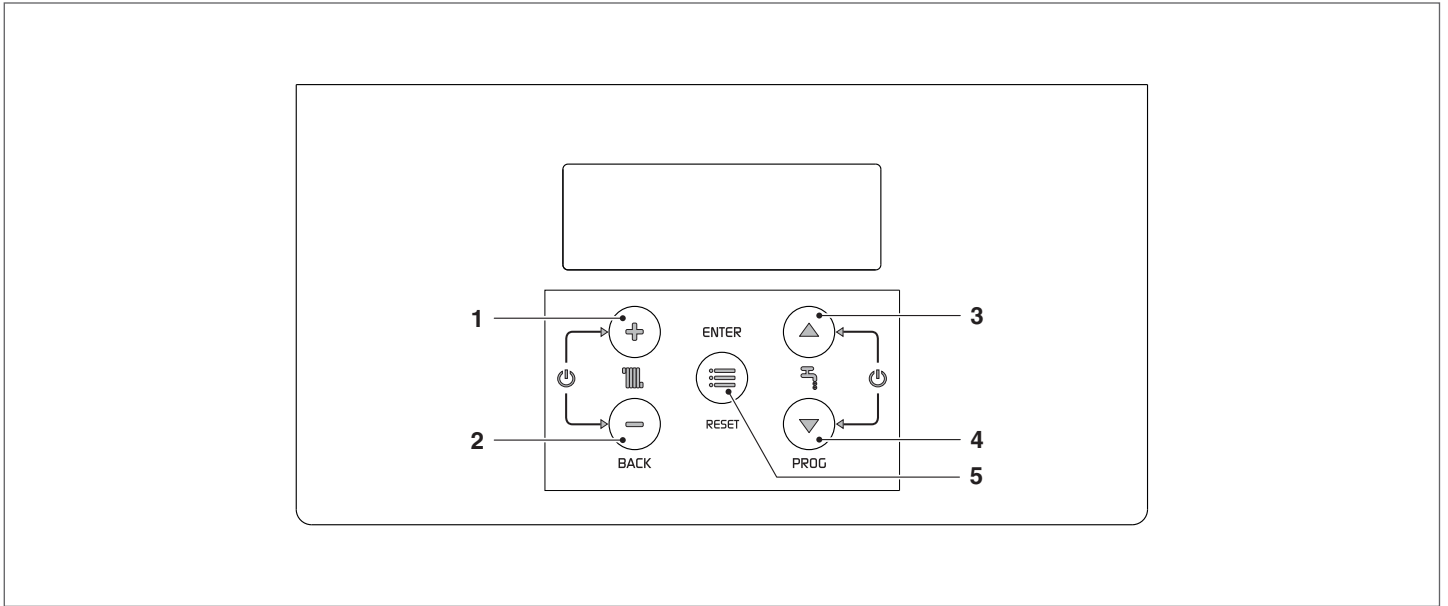

In this mode, keys have the following functions:

Nr.	Button	Function
1	"+"	It increases the heating setpoint (when active/available)
2	"-"	It decreases the heating setpoint (when active/available)
3	"▲"	Raise the DHW set point (when available)
4	"▼"	Decrease the DHW set point (when available)
5	"ENTER/RESET"	Enters into "MENU" mode If pressed for more than 5 seconds, it resets a permanent error (Loc)

Additional functions:

Button	Function
"+" with "-"	It accesses enable/disable heating function mode
"▲" + "▼"	It accesses enable/disable DHW production function mode

For more information, see paragraph "Enable/disable the heating function" on page 15.

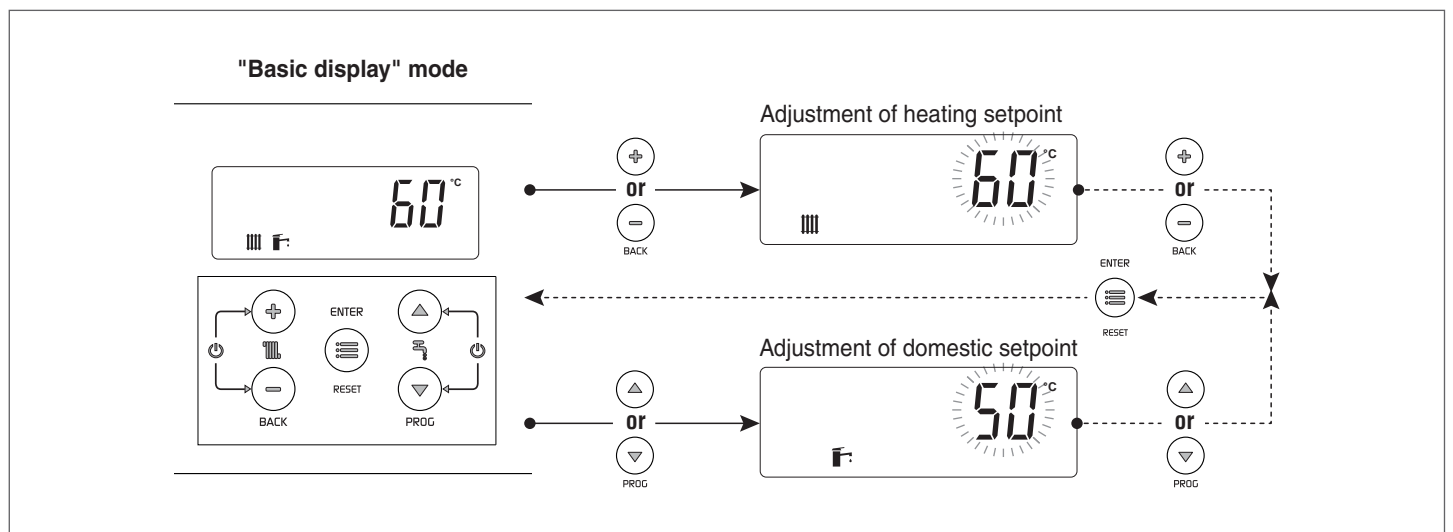

MENU selection

Enters into "MENU" mode when "MENU/RESET" key is pushed. The figures of the small display indicate "0000" which is the first accessible menu.

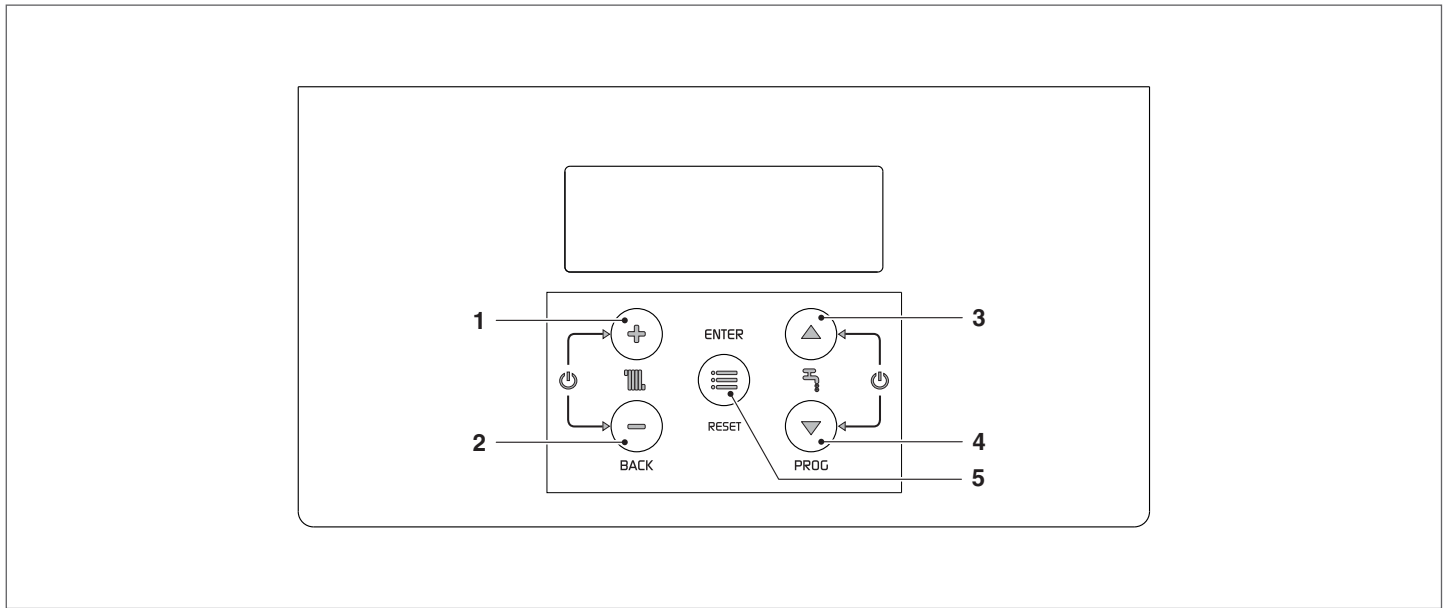

In this mode, keys have the following functions:

Nr.	Button	Function
1	"+"	Exits from the menu and cancels a parameter change
2	"-"	Exits from the menu and cancels a parameter change
3	"▲"	Selects the following menu or increases a certain parameter value
4	"▼"	Selects the previous menu or decreases a certain parameter value
5	"ENTER/RESET"	Enters into the selected menu/parameter or confirms the parameter change

1.8 Navigation scheme

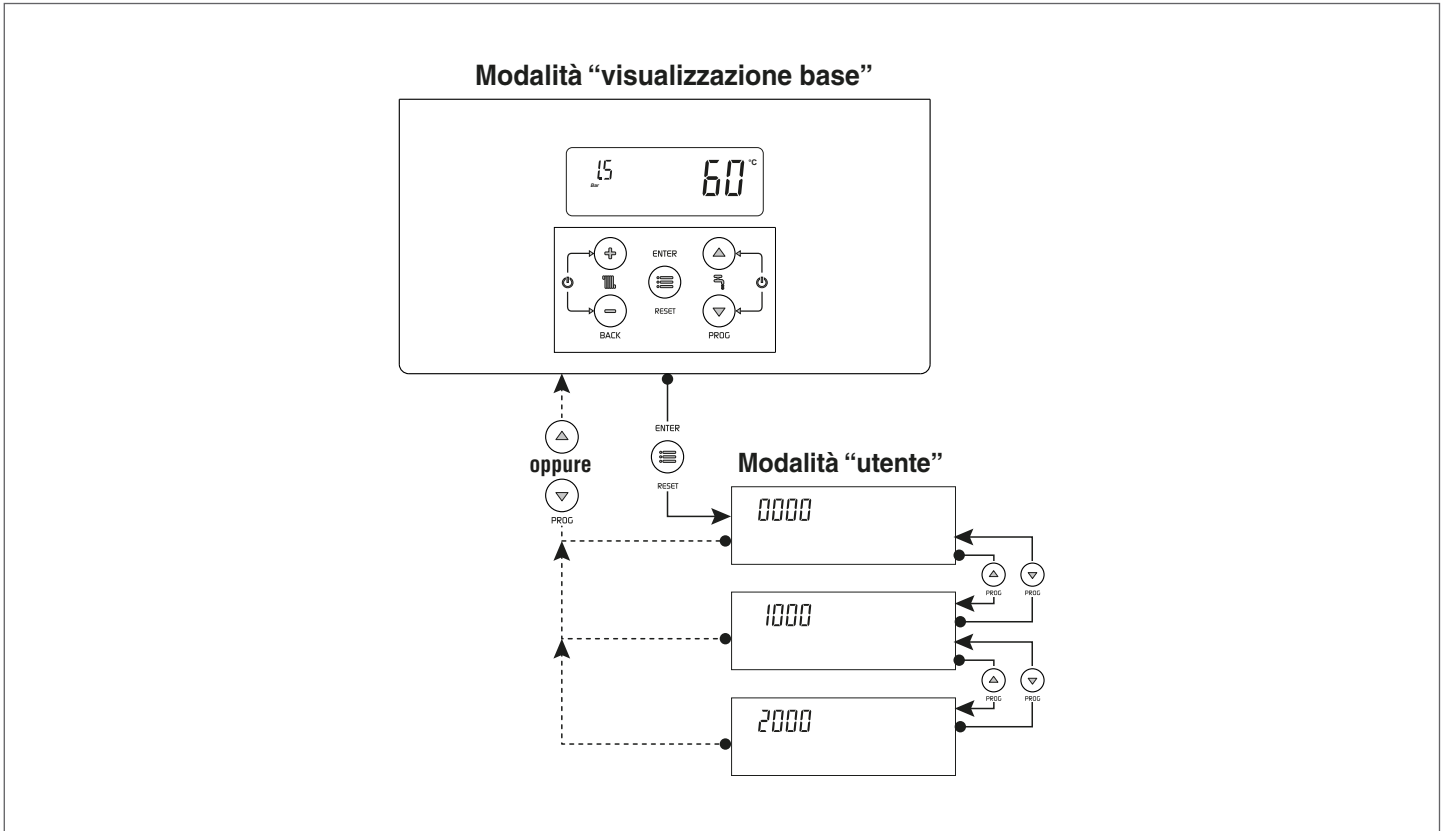

Example of parameter setting

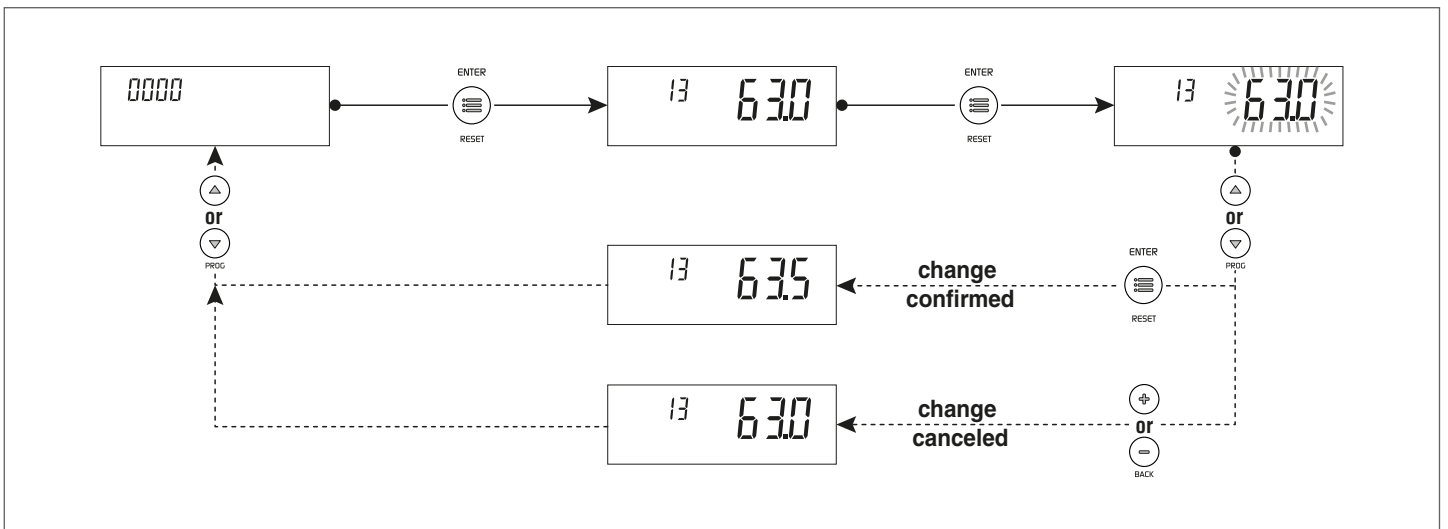

1.9 List of user parameters

Menu	Par. No.	Description	Range	Default setting	UM
Main menu					
0000	013	Quick adjustment of direct Zone/Zone 1 heating setpoint in 0 and 3 heating modes. By connecting the zone control accessory, this parameter can be used to quickly change direct Zone/Zone 1 setpoint. This parameter simultaneously modifies the value of Par. 2103.	See Par. 2103	See Par. 2103	°C
0000	023	Quick adjustment of Zone 2 heating setpoint in 0 and 3 heating modes. By connecting the zone control accessory, this parameter can be used to quickly change Zone 2 setpoint. This parameter simultaneously modifies the value of Par. 2203.	See Par. 2203	See Par. 2203	°C
0000	033	Quick adjustment of Zone 3 heating setpoint in 0 and 3 heating modes. By connecting the zone control accessory, this parameter can be used to quickly change Zone 3 setpoint. This parameter simultaneously modifies the value of Par. 2303.	See Par. 2303	See Par. 2303	°C
0000	047	Quick adjustment of DHW setpoint with heater This parameter is only visible with Par. 2035 = 1	See Par. 2047		°C
0000	048	Quick adjustment of DHW setpoint with instant production This parameter is only visible with Par. 2035 = 10	See Par. 2048		°C
0000	201	Stops the venting function 0 = No action 1 = Stop venting Visible only when de-aeration is in operation	0...1	0	
Info menu					
1000	1001	CH flow temperature			°C
1000	1002	Domestic hot water temperature			°C
1000	1003	Domestic cold water temperature This parameter is only visible with Par. 2035 = 10			°C
1000	1004	Outdoor temperature			°C
1000	1007	Return temperature			°C
1000	1033	System pressure			bar
1000	1056	Total hours of operation in heating mode			h x 10
1000	1057	Total hours of operation in domestic mode			h x 10
1000	1058	Total hours of operation			h x 10
1000	1062	Function not implemented			
1000	1063	Input signal 0-10V			V
1000	1090	Counts down the days to the next service (if it's past, a negative value is shown) If the value is < 15 the service icon flashes			Days
1000	1101	Direct Zone/Zone 1 delivery temperature			°C
1000	1102	Direct Zone/Zone 1 ambient temperature			°C
1000	1112	Zone 1 heating setpoint			°C
1000	1201	Zone 2 delivery temperature			°C
1000	1202	Zone 2 ambient temperature			°C
1000	1212	Zone 2 heating setpoint			°C
1000	1301	Zone 3 delivery temperature			°C
1000	1302	Zone 3 ambient temperature			°C
1000	1312	Zone 3 heating setpoint			°C

Menu	Par. No.	Description	Range	Default setting	UM
Heating general settings					
2000	2021	Number of days to next service		365	Days
2000	2022	Service reminder This function reminds the user of the need to carry out a programmed service on the boiler, after the number of days set in Par. 2021 0 = Deactivates the function 1 = Activates the function 2 = Resets the countdown of days to next service to zero	0...2	0	
2000	2078	Set service hours countdown 0= Burner's hours of operation 1 = Boiler's hours of operation	0...1	0	
Direct Zone / Zone 1 Heating Settings					
2000	2103	Direct Zone/Zone 1 setpoint in heating mode Par. 2001= 0 and 3 The thermal unit adjustment determines the boiler setpoint in heating mode, using the highest value among the requests of all the active zones (Par. 1101, 1201, 1301) If Zone 1 is configured as mixed, the value set in parameter 1112 will be used as setpoint	If Zone 1 is not enabled: (Par. 2121, Par. 2024) If Zone 1 is enabled: BT: (Par. 2121, 45) AT: (Par. 2121, Par. 2024)	70 (AT) 45 (BT)	°C
2000	2130	Parallel shift of direct Zone/Zone 1 climatic curve	-10...10	0	°C
Zone 2 Heating Settings					
2000	2203	Zone 2 heating setpoint in 0 and 3 heating modes The thermal unit adjustment determines the boiler setpoint in heating mode, using the highest value among the requests of all the active zones (Par. 1101, 1201, 1301) If Zone 2 is set as mixed, the value set in parameter 1212 will be used as the setpoint.	BT: (Par. 2221, 45) AT: (Par. 2221, Par. 2024)	70 (AT) 45 (BT)	°C
2000	2230	Parallel shift of direct Zone/Zone 1 climatic curve	-10...10	0	°C
Zone 3 Heating Settings					
2000	2303	Zone 3 heating setpoint in 0 and 3 heating modes The thermal unit adjustment determines the boiler setpoint in heating mode, using the highest value among the requests of all the active zones (Par. 1101, 1201, 1301) If Zone 3 is set as mixed, the value set in parameter 1312 will be used as the setpoint.	BT: (Par. 2321, 45) AT: (Par. 2321, Par. 2024)	70 (AT) 45 (BT)	°C
2000	2330	Parallel shift of direct Zone/Zone 1 climatic curve	-10...10	0	°C
DHW settings and system configuration					
2000	2047	DHW setpoint with heater This parameter is only visible with Par. 2035 = 1	40...65	57	°C
2000	2048	DHW setpoint with instant production This parameter is only visible with Par. 2035 = 10	40...70	45	°C
Error log					
9000	9001	Error log - 1	0...9999		
9000	9002	Error log - 2	0...9999		
9000	9003	Error log - 3	0...9999		
9000	9004	Error log - 4	0...9999		
9000	9005	Error log - 5	0...9999		
9000	9006	Error log - 6	0...9999		
9000	9007	Error log - 7	0...9999		
9000	9008	Error log - 8	0...9999		
9000	9009	Error log - 9	0...9999		
9000	9010	Error log - 10	0...9999		

2 USE

2.1 Putting into service

Have the **RIEHO** Technical Assistance Service start up your **INSIEME EVOe 25 LN** boiler for the first time. Once this has been done, the boiler can be left to function automatically. Under certain circumstances, such as after long periods of disuse, the user may need to re-start it without involving the Technical Assistance Service.

2.1.1 Preliminary operations

Perform the following checks before starting up the boiler:

- Check that the fuel shut-off cock and heating system shut-off cock are open

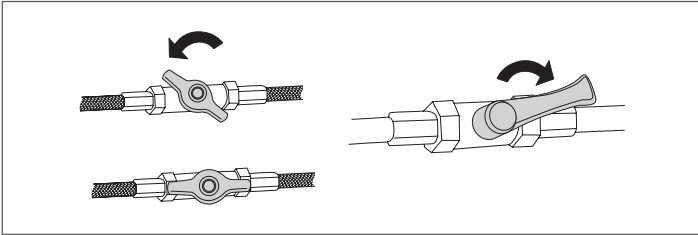

- the pressure of the hydraulic circuit, with cold water, is **1.5 bar** (value indicated on the first screen of the control panel display) and the circuit is not vented
- The thermal unit **INSIEME EVOe 25 LN** is equipped with a system load valve located inside the thermal unit

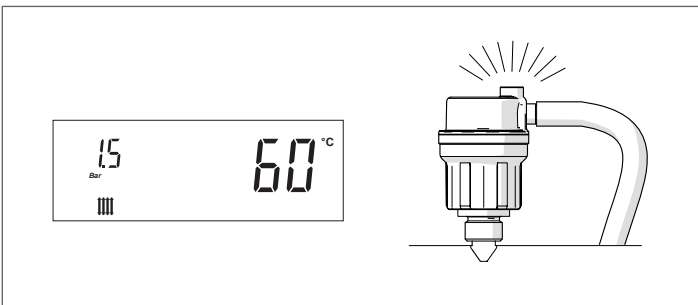

- close the system load valve.

2.1.2 Start-up

Once you have completed all the checks listed above, proceed as follows to start up the boiler for the first time:

- set the main switch of the system to ON and the main switch of the equipment to (I).

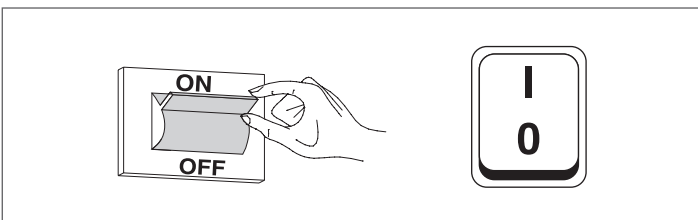

Upon switching on, the display of the control interface of the device shows the following pages in sequence.

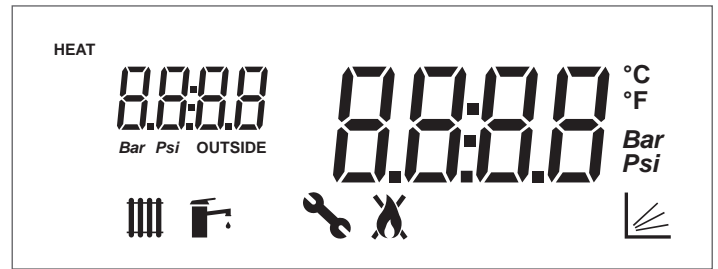

Firmware version of the thermal unit interface.

In the example the message indicates a firmware version = 0.

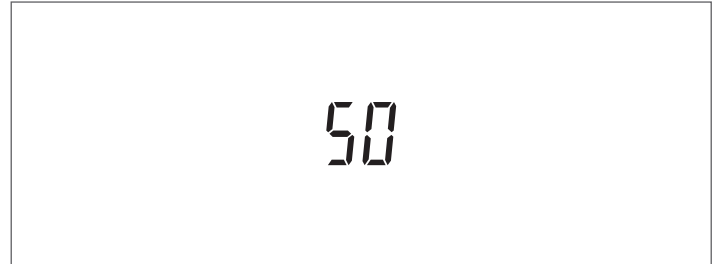

Communication test between interface and regulator.

The message "init" will appear briefly to indicate the beginning of the communication between the interface and regulator inside the thermal unit (*)

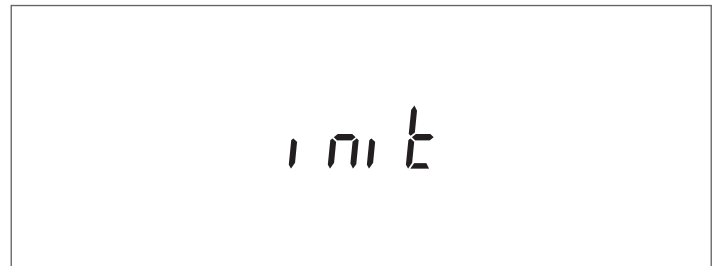

Firmware version of the thermal unit regulator.

In the example the message indicates a firmware version = 1.



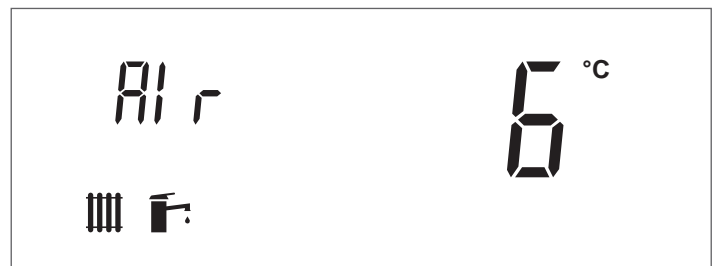

At first start-up and at every restoration of the power supply the venting function signalled by the message "Air" activates. The vent cycle lasts 14 minutes.



- (*) If the communication test fails the message "no COMM" will appear



Once the initialization phase is complete, the display switches to "basic display" mode.

In this mode, the main information on the equipment operation is displayed. The meaning of the different icons displayed is explained in paragraph "Control panel". The icon  and the heating delivery temperature are displayed, either if the boiler is in stand-by mode or if a temperature request is active (icon  blinking).

To switch off the equipment, set the main switch to "0".

-  Never power off the appliance before switching the master switch to the "0" position.

-  Never switch off the appliance with the master switch if a request is active. Always make sure that the appliance is in stand-by before switching the main switch.

Example of generator stand-by display in heating only mode (external probe not connected)

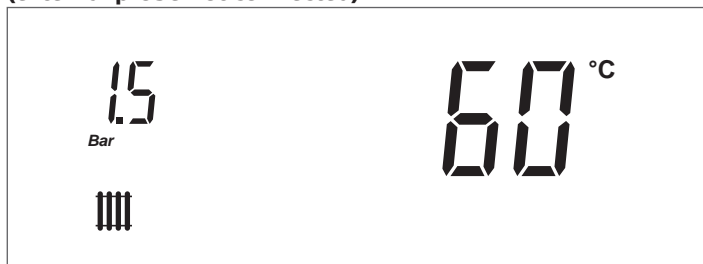

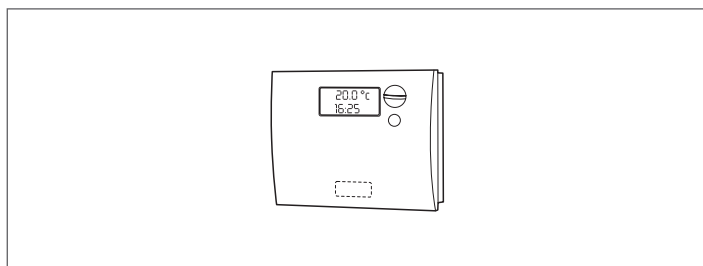

- Set the room thermostat to the required temperature (~20°C) or, if the system has a timer or timer-thermostat, make sure that this is switched "ON" and adjusted to the required temperature (~20°C);



2.1.3 Adjustment of heating setpoint

- Press the key "+" or "-" to display the current value of the heating temperature setpoint.



- Increase or decrease the setpoint according to the type of system by using the key "+" of "-".
- To save the modification made and go back to the initial screen, wait for 3 seconds or press the key "ENTER/RESET".
- Check that the thermal unit starts the ignition phase and that the display shows the icon  blinking (ambient heating request) and the icon .
- The boiler now starts up and the burner remains lit until the temperature setpoint is reached.

2.1.4 Enable/disable the heating function

- Press the keys "+" and "-" simultaneously for a few seconds;
- The icon  and the current heating mode (ON or OFF) will blink on the display;

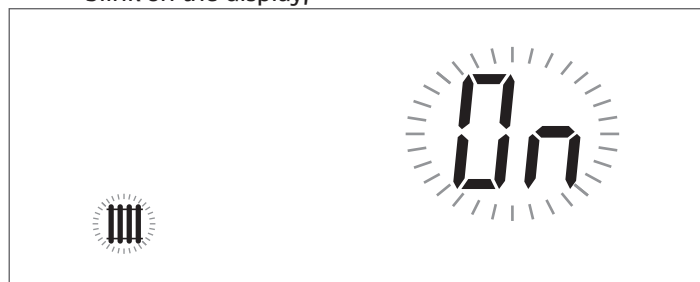

- Press the keys "+" and "-" to select the required mode;
- Press the key "ENTER/RESET" or wait for 3 seconds to save the modification made and go back to the initial screen.

2.1.5 Enable/disable the domestic function

- Press the keys "▲" and "▼" simultaneously for a few seconds;
- The icon  and the current domestic mode (ON or OFF) will blink on the display;



- Press the keys "▲" and "▼" to select the required mode;
- To save the modification made and go back to the initial screen, press the key "ENTER/RESET".

2.1.6 Adjustment of domestic setpoint

- Press the key "▲" or "▼" to display the current value of domestic setpoint.



- Increase or decrease the setpoint by using the key "▲" or "▼".
- To save the modification made and go back to the initial screen, press the key "ENTER/RESET".

2.1.7 Special functions

When a special function is active, a specific message is shown on the display of the device control interface.

Pump activation protection during a Domestic Water request

If during a domestic water request the delivery temperature of the burner is lower than that of the heater the pump will not be activated.

Frost protection

The anti-freeze protection function protects the system against freezing.

When the anti-freeze function is active, the message "AFro" is displayed.

The intervention modes are the following:

- **Burner anti-freeze protection:** If the temperature of the delivery probe of the device drops below 5°C the burner turns on and stays on until the delivery temperature exceeds 10°C (with the external probe connected the protection activates only with external temperature values < 10°C).
- **Heating circuit anti-freeze protection:** If the burner stays off for 6 consecutive hours the circulator of the device will activate for 5 minutes. If the temperature of the delivery probe of the device drops below 5°C the burner turns on and stays on until the delivery temperature exceeds 10°C (with the external probe connected the protection activates only with external temperature values < 10°C).
- **Domestic circuit heater anti-freeze protection:** If the temperature of the heater probe drops below 5°C the burner turns on and the circulator and 3-way diverting valve will activate. The burner stays on until the temperature of the storage tank sensor exceeds 10°C and the pump continues to operate for the post-circulation time. With the external sensor connected, protection is activated only when the external temperature is < 10°C.

Venting

The function is automatically enabled at the first start-up and at each reset of the power supply.

When the function is active, the message "Air" is displayed.

During the venting, the circulator is enabled, so that the air which may be present inside the system circuit can exit through the automatic drain valve of the device.

The status of the light guide changes to flashing green.

Circulator and 3-way valve activation every 24 hours

Every 24 hours the circulator and 3-way diverting valve are activated for 30 seconds (only in heating mode 0,1,4).

This function prevents the circulator and valve from getting stuck in a determined position.

Anti-legionella function - With Heater Probe only

The function is automatically enabled when the heater sensor is connected, at each reset of the power supply or daily, if necessary.

When the function is on, the message "ALE9" is shown next to the storage tank temperature.

The function increases the water temperature inside the heater up to 60°C and keeps it for 30 minutes.

Once this time has elapsed, the control box normal operation is restored.

2.1.8 Ignition failure

If an ignition or operating anomaly occurs, the thermal unit display will show a text message (small digit) and a number (large digit), which vary according to the anomaly detected.

There are 3 error levels:

- Permanent (Loc)
- Temporary (Err)
- Alerts (AttE)

Permanent Error

The text "Loc" is displayed together with the permanent error number. The icon  indicates that the burner is disabled. The equipment must be manually reset by keeping the key "ENETER/RESET" pressed.



Temporary Error

The text "Err" is displayed together with the temporary error number.

The icon  indicates that the burner is disabled.

The lock-out error must be solved.

Contact your local Technical Assistance Service

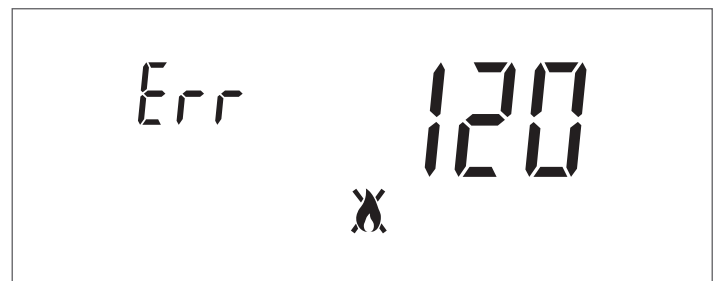

Warnings

The text "AttE" is displayed together with the alert number.
The equipment is not locked out, but its functions may be limited (according to the alert).

Contact your local Technical Assistance Service



2.2 Temporary or short-term shut-down

In the event of temporary or short-term shut-down (e.g. due to holidays), proceed as follows:

- Remove the power supply by setting the main switch of the equipment and the main switch of the system to "OFF".
- If there is a danger of frost, keep the system on. To reduce fuel consumption, set the heating set point to the minimum allowed value.

2.3 Preparing for extended periods of disuse

If the appliance is not going to be used for a long period of time, the following operations should be carried out: set the main switch of the system to OFF and the main switch of the equipment to (0);

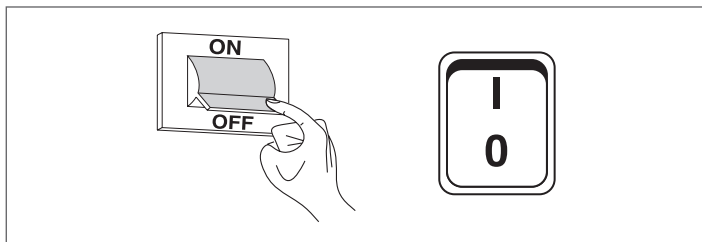

- close the fuel cock and heating circuit water cock.

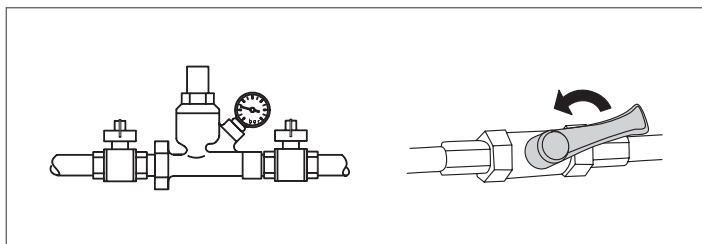

⚠ Drain the central heating circuit if there is any risk of freezing.

2.4 Device cleaning and maintenance

Please remember that THE PERSON RESPONSIBLE FOR SYSTEM MANAGEMENT MUST ENSURE THAT PROFESSIONALLY QUALIFIED HEATING ENGINEERS UNDERTAKE PERIODIC MAINTENANCE AND COMBUSTION EFFICIENCY MEASUREMENTS.

RIELLO's Technical Assistance Service is qualified to satisfy these legal requirements and can also provide useful information on MAINTENANCE PROGRAMMES designed to guarantee:

- Greater safety
- Compliance with applicable legislation
- Freedom from the risk of fines in the event of spot checks.

Regular maintenance is essential for the safety, efficiency and durability of the boiler.

Servicing is a legal requirement and must be performed at least once a year by a professionally qualified heating engineer.

2.5 External cleaning

Clean the boiler's casing panels and control panel with a soft cloth damped in soapy water.

To remove marks from the boiler casing, use a cloth damped in a 50% mix of water and denatured alcohol or a suitable cleaning product.

Wipe the boiler dry after cleaning it.

⊘ Do not use abrasive products, petrol or triethylene.

2.6 Annual cleaning

At least once a year, the user must have the boiler served by **RIELLO's** Technical Assistance Service or by a qualified heating engineer.

2.7 Troubleshooting

FAULT	CAUSE	SOLUTION
There is a smell of fumes	Fumes escaping into the air	- Contact your local Technical Assistance Service
The generator is at temperature but the heating system is cold	Air in the circuit	- Contact your local Technical Assistance Service
	Pump malfunctioning	- Contact your local Technical Assistance Service
The boiler does not reach its temperature setpoint	Boiler temperature setpoint	- Check the temperature setting - Contact your local Technical Assistance Service
The generator triggers a thermal safety block	Safety thermostat / delivery overtemperature	- Contact your local Technical Assistance Service
	No water	- Contact your local Technical Assistance Service
The safety valve keeps opening	Incorrect central heating circuit pressure	- Contact your local Technical Assistance Service
	CH expansion vessel	- Contact your local Technical Assistance Service
The circulator does not work	Pump seized Electrical connections	- Contact your local Technical Assistance Service
	The request from the ambient thermostat is missing	- Check the temperature set on the ambient thermostat - Contact your local Technical Assistance Service

3 RECYCLING AND DISPOSAL

The device is primarily composed of:

Material	Component
Metal materials	Pipes, circulator, boiler body
ABS (acrylonitrile-butadiene-styrene)	Control panel enclosure
Glass wool felt	Boiler body insulation
Electrical and electronic components	Cables and wirings, regulator, circulator

At the end of the life cycle, safely remove the components and dispose of them in a responsible manner, in compliance with the installation country's applicable environmental legislation.

 Adequate sorted waste collection, processing and environmentally-friendly disposal contribute to preventing possible negative impacts on the environment and health and promote the reuse and/or recycling of the materials of which the appliance consists.

 Illegal disposal of the product by the owner shall be subject to administrative fines provided for by applicable laws.



A series of horizontal dashed lines spanning the width of the page, intended for writing or drawing.

RIELLO

RIELLO S.p.A.
Via Ing. Pilade Riello, 7
37045 - Legnago (VR)
www.riello.com

The manufacturer strives to continuously improve all products. Appearance, dimensions, technical specifications, standard equipment and accessories are therefore liable to modification without notice.