

**GB** Premix gas burners

Modulating operation with pilot flame ignition



CODE	MODEL	
20148874	RX 700 S/PV	854T4
20148875	RX 850 S/PV	926T4
20148877	RX 1000 S/PV	891T4




**Translation of the original instructions**

<b>1</b>	<b>Declarations</b>	<b>3</b>
<b>2</b>	<b>Information and general warnings</b>	<b>5</b>
2.1	Information about the instruction manual	5
2.1.1	Introduction	5
2.1.2	General dangers	5
2.1.3	Other symbols	5
2.1.4	Delivery of the system and the instruction manual	6
2.2	Guarantee and responsibility	6
<b>3</b>	<b>Safety and prevention</b>	<b>7</b>
3.1	Introduction	7
3.2	Personnel training	7
<b>4</b>	<b>Technical description of the burner</b>	<b>8</b>
4.1	Models available	8
4.2	Burner categories - Countries of destination	8
4.3	Technical data	8
4.4	Electrical data	9
4.5	Maximum dimensions	9
4.6	Burner equipment	9
4.7	Burner description	10
4.8	Firing rates	11
4.9	Test boiler	12
4.10	Output supplied	13
4.11	Adjustment pilot	14
4.12	Burner controls (LME71... with PME71.901...)	18
4.12.1	Indication of the diagnostic mode	23
<b>5</b>	<b>Installation</b>	<b>24</b>
5.1	Notes on safety for the installation	24
5.2	Handling	24
5.3	Preliminary checks	24
5.4	Operating position	25
5.5	Preparing the boiler	25
5.5.1	Boring the boiler plate	25
5.5.2	Head length	25
5.6	Securing the burner to the boiler	26
5.6.1	Standard head version	26
5.7	Fuel supply	27
5.7.1	Gas train	28
5.8	Electrical wiring	29
5.8.1	Supply cables and external connections passage	30
5.8.2	Opening sequence of the fuse-holder	31
<b>6</b>	<b>Calibration and operation</b>	<b>32</b>
6.1	Operator panel with LCD AZL 21... display for control box LME 71... with PME 71.901...	32
6.2	Operator panel with LCD display	33
6.3	Visualisation and programming modes	34
6.3.1	Operation	34
6.3.2	Displaying the operating position	35
6.3.3	Fault messages, display errors and information	35
6.4	Info level	36
6.4.1	Displaying the Info level	36
6.5	Displaying the Info values	37
6.5.1	Identification date	37
6.5.2	Identification number	37
6.5.3	Burner identification	38

6.5.4	Number of resettable start-ups .....	38
6.5.5	Total number of start-ups .....	39
6.5.6	End of the Info level.....	39
6.6	Service level .....	40
6.6.1	Displaying the Service values .....	41
6.7	Parameters level .....	42
6.7.1	Entering the password.....	43
6.7.2	Backup .....	44
6.7.3	Restore.....	45
6.8	Parameter modes of operation .....	47
6.8.1	Parameters without index, with direct display .....	47
6.8.2	Parameters without index, without direct display .....	48
6.8.3	Parameters with index, with or without direct display .....	50
<b>7</b>	<b>Start-up, calibration and operation of the burner .....</b>	<b>52</b>
7.1	Notes on safety for the first start-up .....	52
7.2	Adjustments prior to ignition .....	52
7.3	Fan adjustment.....	52
7.4	Pre-setting of the points P0 (ignition), P1 (minimum) and P2 (maximum).....	53
7.5	Burner start-up .....	54
7.5.1	First burner start-up (manual operation).....	54
7.5.2	Checking the modulating operation (automatic operation).....	55
7.6	Combustion head .....	56
7.7	Burner adjustment .....	57
7.7.1	Indicative calibration values .....	57
7.8	Switching off the burner.....	57
7.9	Load controller inputs .....	57
7.10	Final checks (with burner operating) .....	58
<b>8</b>	<b>Maintenance .....</b>	<b>59</b>
8.1	Notes on safety for the maintenance.....	59
8.2	Maintenance programme .....	59
8.2.1	Maintenance frequency .....	59
8.2.2	Safety test - with gas ball valve closed.....	59
8.2.3	Checking and cleaning .....	59
8.2.4	Safety components.....	60
8.3	Opening and closing the burner .....	60
8.4	Recommended preventive maintenance programme .....	61
<b>9</b>	<b>Operation, indications, diagnostic .....</b>	<b>62</b>
9.1	Control sequence in the event of a fault.....	62
9.2	List of error codes with operation using AZL21... Display .....	63
9.3	Resetting of burner control .....	64
9.3.1	Diagnostics of the cause of the fault .....	64
9.3.2	Before starting with a new program module or when the program module is replaced.....	65
9.4	Manual reset.....	66
9.4.1	Error during the reset process .....	67
9.4.2	Reset .....	67
<b>10</b>	<b>List of parameters PME71.901... .....</b>	<b>68</b>
<b>A</b>	<b>Appendix - Accessories .....</b>	<b>71</b>
<b>B</b>	<b>Appendix - Electrical panel layout.....</b>	<b>72</b>

**1 Declarations**

**Declaration of Conformity in accordance with ISO / IEC 17050-1**

Manufacturer:	RIELLO S.p.A.		
Address:	Via Pilade Riello, 7 37045 Legnago (VR)		
Product:	Pre-mixed gas burner		
Model and type:	RX 700 S/PV	854T4	
	RX 850 S/PV	926T4	
	RX 1000 S/PV	891T4	
These products are in compliance with the following Technical Standards:			
EN 676			
EN 12100			
and according to the European Directives:			
GAR	2016/426/EU		Gas Appliances Regulation
MD	2006/42/EC		Machine Directive
LVD	2014/35/EU		Low Voltage Directive
EMC	2014/30/EU		Electromagnetic Compatibility
The products are marked as follows:			
 <b>CE-0123CT1618</b>			

The quality is guaranteed by a quality and management system certified in accordance with ISO 9001:2015.

Legnago, 03.05.2021

Research & Development Director  
RIELLO S.p.A. - Burner Department

Mr. F. Maltempì



**Manufacturer's Declaration**

**RIELLO S.p.A.** declares that the following products comply with the NOx emission limits specified by German standard "1. BIm-SchV revision 26.01.2010".

Product	Type	Model	Output
Pre-mixed gas burner	854T4	RX 700 S/PV	140 - 700 kW
	926T4	RX 850 S/PV	170 - 880 kW
	891T4	RX 1000 S/PV	180 - 1080 kW

### Declaration of Conformity A.R. 8/1/2004 & 17/7/2009 – Belgium

Manufacturer: RIELLO S.p.A.  
37045 Legnago (VR) Italy  
Tel. ++39.0442630111  
www.riello.com

Distributed by: RIELLO NV  
VAN MARCKE HQ  
LAR Blok Z 5,  
B-8511 Kortrijk (Aalbeke) BE  
Tel. +32 56 23 7511  
e-mail: riello@vanmarcke.be  
URL. www.vanmarcke.com

This document certifies that the series of devices specified below is in compliance with the model described in the EC Declaration of Conformity and has been manufactured and distributed in compliance with the requirements defined in the Legislative Decree of January 8th 2004 and July 17th 2009.

Type of product: Pre-mixed gas burner

Model: RX 700 S/PV  
RX 850 S/PV  
RX 1000 S/PV

Regulation applied: EN 676 and A.R. of January 8th 2004 - July 17th 2009

Controlling organisation: TÜV Industrie Service GmbH  
TÜV SÜD Gruppe  
Ridlerstrasse, 65  
80339 München DEUTSCHLAND

Values measured:	RX 700 S/PV	CO max: 17 mg/kWh	NOx max: 61 mg/kWh
	RX 850 S/PV	CO max: 2 mg/kWh	NOx max: 67 mg/kWh
	RX 1000 S/PV	CO max: 13 mg/kWh	NOx max: 66 mg/kWh

**2 Information and general warnings**

**2.1 Information about the instruction manual**

**2.1.1 Introduction**

The instruction manual supplied with the burner:

- is an integral and essential part of the product and must not be separated from it; it must therefore be kept carefully for any necessary consultation and must accompany the burner even if it is transferred to another owner or user, or to another system. If the manual is lost or damaged, another copy must be requested from the Technical Assistance Service of the area;
- is designed for use by qualified personnel;
- offers important indications and instructions relating to the installation safety, start-up, use and maintenance of the burner.

**Symbols used in the manual**

In some parts of the manual you will see triangular DANGER signs. Pay great attention to these, as they indicate a situation of potential danger.

**2.1.2 General dangers**

The **dangers** can be of **3 levels**, as indicated below.



Maximum danger level!  
This symbol indicates operations which, if not carried out correctly, cause serious injury, death or long-term health risks.



This symbol indicates operations which, if not carried out correctly, may cause serious injury, death or long-term health risks.



This symbol indicates operations which, if not carried out correctly, may cause damage to the machine and/or injury to people.

**2.1.3 Other symbols**



**DANGER: LIVE COMPONENTS**  
This symbol indicates operations which, if not carried out correctly, lead to electric shocks with lethal consequences.



**DANGER: FLAMMABLE MATERIAL**  
This symbol indicates the presence of flammable materials.



**DANGER: BURNING**  
This symbol indicates the risks of burns due to high temperatures.



**DANGER: CRUSHING OF LIMBS**  
This symbol indicates the presence of moving parts: danger of crushing of limbs.



**WARNING: MOVING PARTS**

This symbol indicates that you must keep limbs away from moving mechanical parts; danger of crushing.



**DANGER: EXPLOSION**

This symbol signals places where an explosive atmosphere may be present. An explosive atmosphere is defined as a mixture - under atmospheric conditions - of air and flammable substances in the form of gases, vapours, mist or dust in which, after ignition has occurred, combustion spreads to the entire unburned mixture.



**PERSONAL PROTECTION EQUIPMENT**

These symbols indicate the equipment that must be worn and kept by the operator for protection against threats against safety and/or health while at work.



**OBLIGATION TO ASSEMBLE THE COVER AND ALL THE SAFETY AND PROTECTION DEVICES**

This symbol signals the obligation to reassemble the cover and all the safety and protection devices of the burner after any maintenance, cleaning or checking operations.



**ENVIRONMENTAL PROTECTION**

This symbol gives indications for the use of the machine with respect for the environment.



**IMPORTANT INFORMATION**

This symbol indicates important information that you must bear in mind.

- This symbol indicates a list.

**Abbreviations used**

Ch.	Chapter
Fig.	Figure
Page	Page
Sec.	Section
Tab.	Table

**2.1.4 Delivery of the system and the instruction manual**

When the system is delivered, it is important that:

- The instruction manual is delivered to the user by the system manufacturer, with the recommendation to keep it in the room where the heat generator is to be installed.
- The instruction manual shows:
  - the serial number of the burner;

.....

- the address and telephone number of the nearest Assistance Centre;

.....

.....

.....

- The system supplier must carefully inform the user about:
  - the use of the system;
  - any further tests that may be required before activating the system;
  - maintenance, and the need to have the system checked at least once a year by a representative of the manufacturer or another specialised technician.
 To ensure a periodic check, the manufacturer recommends the drawing up of a Maintenance Contract.

**2.2 Guarantee and responsibility**

The Manufacturer guarantees its new products from the date of installation, in accordance with the regulations in force and/or the sales contract. At the moment of the first start-up, check that the burner is integral and complete.

**WARNING**

Failure to observe the information given in this manual, operating negligence, incorrect installation and carrying out of non authorised modifications will result in the annulment by the manufacturer of the guarantee that it supplies with the burner.

In particular, the rights to the guarantee and the responsibility will no longer be valid, in the event of damage to things or injury to people, if such damage/injury was due to any of the following causes:

- incorrect installation, start-up, use and maintenance of the burner;
- improper, incorrect or unreasonable use of the burner;
- intervention of unqualified personnel;
- carrying out of unauthorised modifications on the equipment;
- use of the burner with safety devices that are faulty, incorrectly applied and/or not working;
- installation of untested supplementary components on the burner;
- powering of the burner with unsuitable fuels;
- faults in the fuel supply system;
- continuation of use of the burner when a fault has occurred;
- repairs and/or overhauls incorrectly carried out;
- modification of the combustion chamber with inserts that prevent the regular development of the structurally established flame;
- insufficient and inappropriate surveillance and care of those burner components most likely to be subject to wear and tear;
- use of non-original components, including spare parts, kits, accessories and optional;
- force majeure.

**The manufacturer furthermore declines any and every responsibility for the failure to observe the contents of this manual.**



**3 Safety and prevention**

**3.1 Introduction**

The burners have been designed and built in compliance with current regulations and directives, applying the known technical rules of safety and envisaging all the potential danger situations.

It is necessary, however, to bear in mind that the imprudent and clumsy use of the equipment may lead to situations of death risk for the user or third parties, as well as the damaging of the burner or other items. Inattention, thoughtlessness and excessive confidence often cause accidents; the same applies to tiredness and sleepiness.

It is a good idea to remember the following:

- The burner must only be used as expressly described. Any other use should be considered improper and therefore dangerous.

In particular:

it can be applied to boilers operating with water, steam, diathermic oil, and to other uses expressly foreseen by the manufacturer;

the type and pressure of the fuel, the voltage and frequency of the electrical power supply, the minimum and maximum deliveries for which the burner has been regulated, the pressurisation of the combustion chamber, the dimensions of the combustion chamber and the room temperature must all be within the values indicated in the instruction manual.

- Modification of the burner to alter its performance and destinations is not allowed.
- The burner must be used in exemplary technical safety conditions. Any disturbances that could compromise safety must be quickly eliminated.
- Opening or tampering with the burner components is not allowed, apart from the parts requiring maintenance.
- Only those parts envisaged by the manufacturer can be replaced.



The manufacturer guarantees safety and proper functioning only if all burner components are intact and positioned correctly.

**3.2 Personnel training**

The user is the person, body or company that has acquired the machine and intends to use it for the specific purpose. He is responsible for the machine and for the training of the people working around it.

The user:

- undertakes to entrust the machine exclusively to suitably trained and qualified personnel;
- undertakes to inform his personnel in a suitable way about the application and observance of the safety instructions. With that aim, the user undertakes to ensure that everyone knows the use and safety instructions for his own duties.
- Personnel must follow all the danger and caution indications shown on the machine.
- Personnel must not carry out, on their own initiative, operations or interventions that are not within their province.
- Personnel are obliged to inform their superiors of every problem or dangerous situation that may arise.
- The assembly of parts of other makes, or any modifications, can alter the characteristics of the machine and hence compromise operating safety. The manufacturing company therefore accepts no responsibility whatsoever for any which may result from the use of non-original parts.

In addition:



- must take all the measures necessary to prevent unauthorised people gaining access to the machine;
- the user must inform the manufacturer if faults or malfunctioning of the accident prevention systems are noticed, along with any presumed danger situation;
- personnel must always use the personal protective equipment envisaged by legislation and follow the indications given in this manual.

### 4 Technical description of the burner

#### 4.1 Models available

Designation	Voltage	Code
RX 700 S/PV	1N/230/50-60	20148874
RX 850 S/PV	1N/230/50-60	20148875
RX 1000 S/PV	3/400/50-60	20148877

Tab. A

#### 4.2 Burner categories - Countries of destination

Country of destination	Gas category
AT - CH - CZ - ES - FR - GB - GR - HR - IE - IS - IT - LT - PT - RO - SI - SK	I12H3P
DE - PL	I2E, I3P
NL	I12EK3P
HU	I2H, I3P
BE	I2E(R), I3P
LU	I2E
BG - DK - EE - FI - LV - NO - SE	I2H
CY - MT	I3P

Tab. B

#### 4.3 Technical data

Model	RX 700 S/PV			RX 850 S/PV			RX 1000 S/PV					
Type	854T4			926T4			891T4					
Power <sup>(1)</sup>	min - max	kW		140 - 700			170 - 880			180 - 1080		
Delivery <sup>(1)</sup>	min - max	Mcal/h		120 - 602			147 - 757			155 - 929		
Fuels	Natural gas: G20-G25 (methane) - LPG: (G31)											
Supply pressure <sup>(2)</sup> -	mbar		17 - 65 (G20-G31)			25 - 65 (G25)						
Gas valve input diameter	1 1/2"											
Operation	<ul style="list-style-type: none"> <li>- Intermittent (min. 1 stop in 24 hours)</li> <li>- Modulating</li> </ul>											
Standard applications	Boilers: water, steam, diathermic oil											
Ambient temperature	°C		0 - 50									
Combustion air temperature	°C max		60									
Burner weight (without packaging)	kg		48			48			58			
Noise level <sup>(3)</sup>	dB(A)		Min.	Average	Max.	Min.	Average	Max.	Min.	Average	Max.	
Sound pressure			50.8	62.0	70.3	50.5	59.9	68.5	50.7	65.8	74.9	
Sound power			63.6	74.8	83.0	63.3	72.7	81.2	63.4	78.6	87.7	

Tab. C

- (1) Reference conditions: Ambient temperature 20°C - Gas temperature 15°C - Barometric pressure 1013 mbar - Altitude 0 m a.s.l.  
 (2) Input gas pressure 8)(Fig. 2) with zero pressure in combustion chamber and at maximum burner output.  
 (3) Sound pressure measured in manufacturer's combustion lab, with burner operating on test boiler, at maximum, average and minimum modulation output. The sound power is measured with the "Free Field" method, as per EN 15036, and according to an accurate "Accuracy: Category 3" measurement, as described in EN ISO 3746.

**4.4 Electrical data**

Model		RX 700 S/PV	RX 850 S/PV	RX 1000 S/PV
Auxiliary circuit electrical supply		-	-	1N ~ 230V +/-10% 50/60Hz
Electrical supply		1N ~ 230V +/-10% 50/60Hz		3 ~ 400V +/-10% 50/60Hz
Fan motor	rpm	4500		6100
	V	230		400
	kW	0.86		2.4
	A	4.8		4
Ignition transformer	V1 - V2 I1 - I2	230 V - 2 x 10 kV 0,3 A - 50/60 Hz 0,4 A		
Absorbed electrical power	kW max	1.2	1.2	2.8
Protection level		IP 2XD		

Tab. D

**4.5 Maximum dimensions**

The maximum dimensions of the burner are given in Fig. 1.

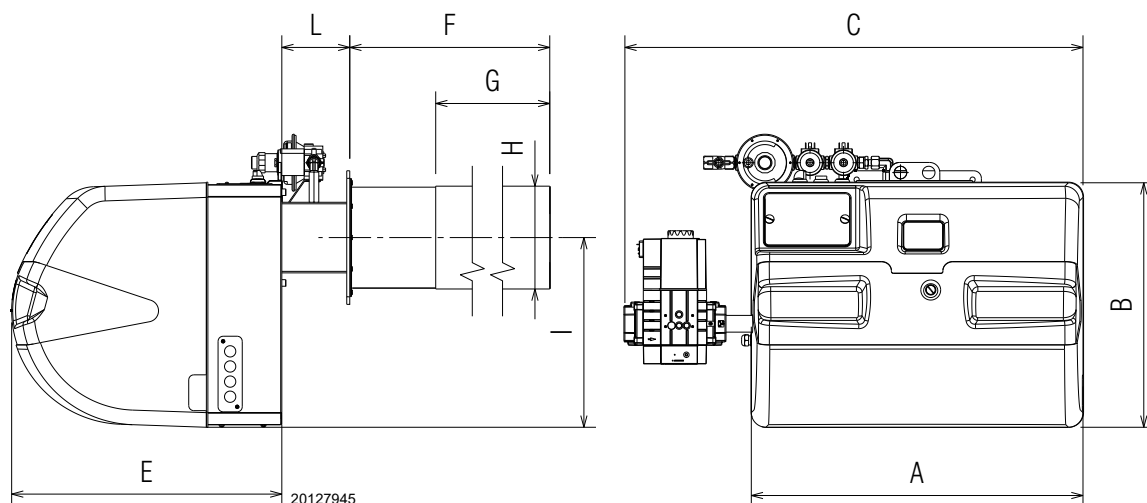


Fig. 1

mm	A	B	C	E	F	G	H	I	L
RX 700 S/PV P	660	490	910	535	540	367	204	375	135
RX 850 S/PV P	660	490	910	535	660	490	204	375	135
RX 1000 S/PV P	660	490	910	535	660	490	204	375	135

Tab. E

**4.6 Burner equipment**

Pilot gas train . . . . .	No. 1	<b>Hardware for burner assembly:</b>	
Flange for gas train . . . . .	No. 1	M10 x 50 Stainless steel nuts (with or without tip) . . . . .	No. 4
Screws to fix the flange . . . . .	No. 4	Zinc plated washers M10 x 16 . . . . .	No. 4
Insulating gasket . . . . .	No. 1	Toothed washers M10 . . . . .	No. 4
Gas valve with flange and gas pipe . . . . .	No. 1	M10 Zinc-plated nuts . . . . .	No. 4
Instructions . . . . .	No. 1	Compensation pipe . . . . .	No. 1
Spare parts list . . . . .	No. 1		

### 4.7 Burner description

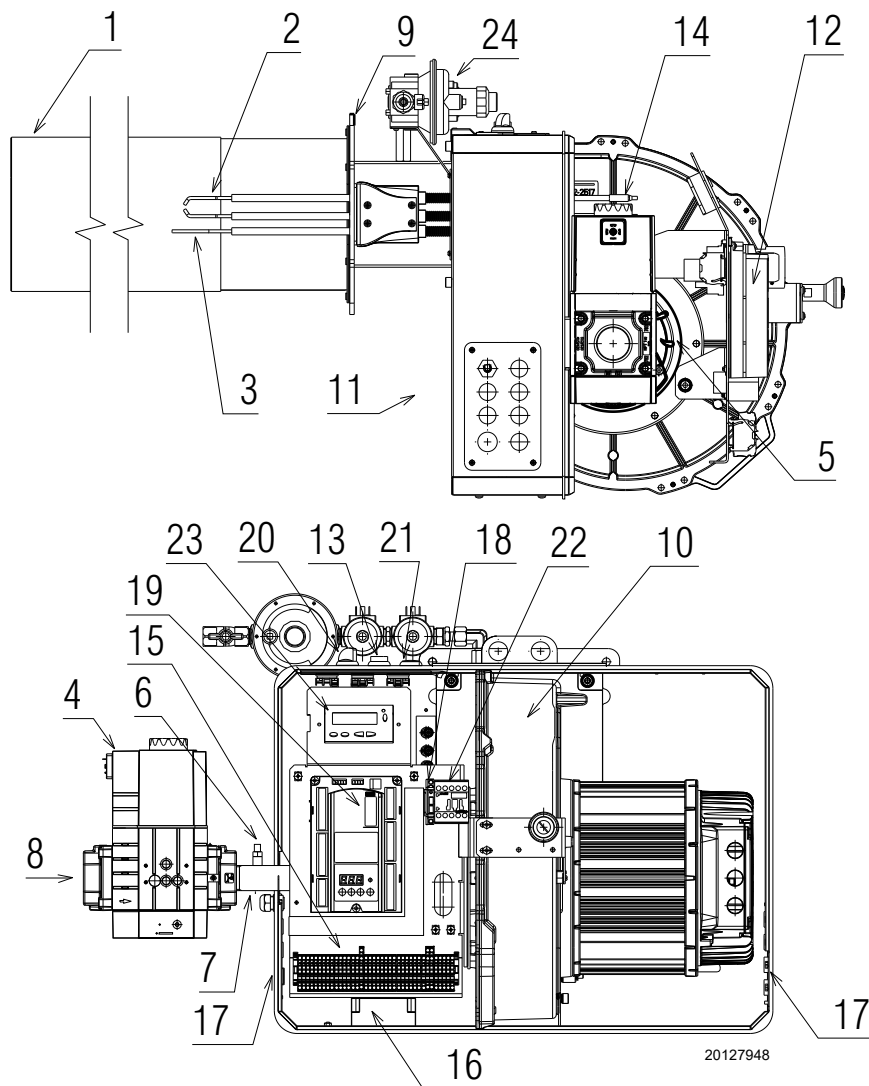


Fig. 2

- 1 Combustion head
- 2 Ignition electrode
- 3 Flame sensor probe
- 4 Gas valve
- 5 Air/gas mixer in the suction line circuit
- 6 Gas pressure test point
- 7 Gas valve pipe
- 8 Gas input
- 9 Boiler fixing flange
- 10 Fan
- 11 Air passage in fan
- 12 Electrical control box
- 13 Luminous push-button for reset
- 14 Plug-socket on ionisation probe cable
- 15 Terminal board for electrical wiring
- 16 Transformer
- 17 Plate with 4 holes, useful for passing electric cables
- 18 Fuses
- 19 Programming card
- 20 ON/OFF selector
- 21 Light signalling of mains live state
- 22 Three-phase contactor fan/output relay
- 23 Display
- 24 Pilot gas train



Burner lockout may occur.

**CONTROL BOX LOCKOUT:**

if the button 13 lights up (Fig. 2) it signals that the burner is in lockout.

Press the push button to reset.

**4.8 Firing rates**

The **maximum output** must not be greater than the maximum limit of the diagram (Fig. 3).

- RX 700 S/PV = 700 kW
- RX 850 S/PV = 880 kW
- RX 1000 S/PV = 1080 kW

The **minimum output** should not be lower than the minimum limit of the diagram (Fig. 3).

- RX 700 S/PV = 140 kW
- RX 850 S/PV = 170 kW
- RX 1000 S/PV = 180 kW

**Ignition** is achieved by means of pilot light. The **ignition output**, is chosen from within the **A** area (Fig. 3). Pilot system operates correctly with specific pressure, see Tab. F.

**Fuel Operating pressure of pilot**

Fuel	Operating pressure of pilot
G20	5 - 20
G25	5 - 26
GPL	5 - 10

**Tab. F**

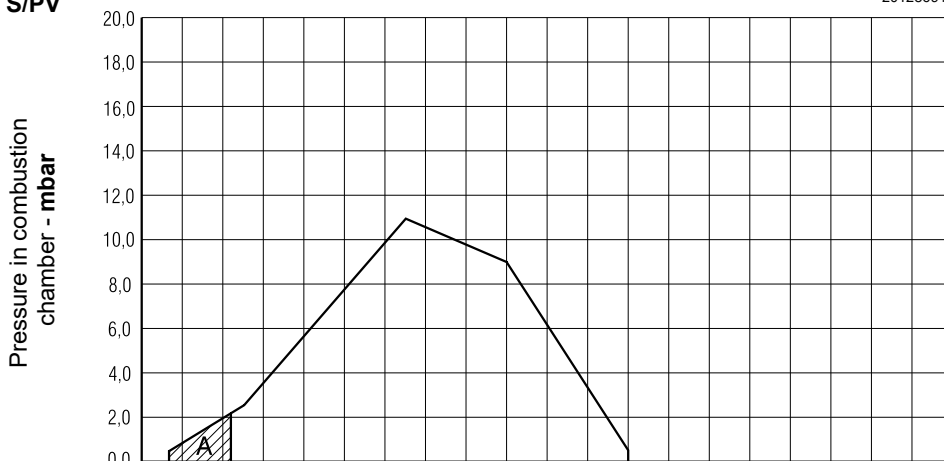
Such value can be varied by means of pressure regulator 3)(Fig. 166 on page 52).



The firing rate (Fig. 3) has been obtained at an ambient temperature of 20°C, at a barometric pressure of 1013 mbar (about 0 m a.s.l.).

**RX 700 S/PV**

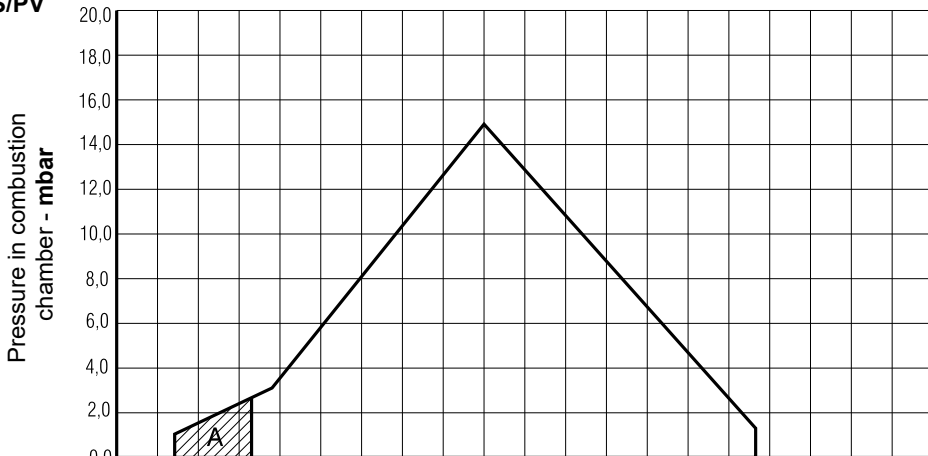
20128691



Thermal power - kW

**RX 850 S/PV**

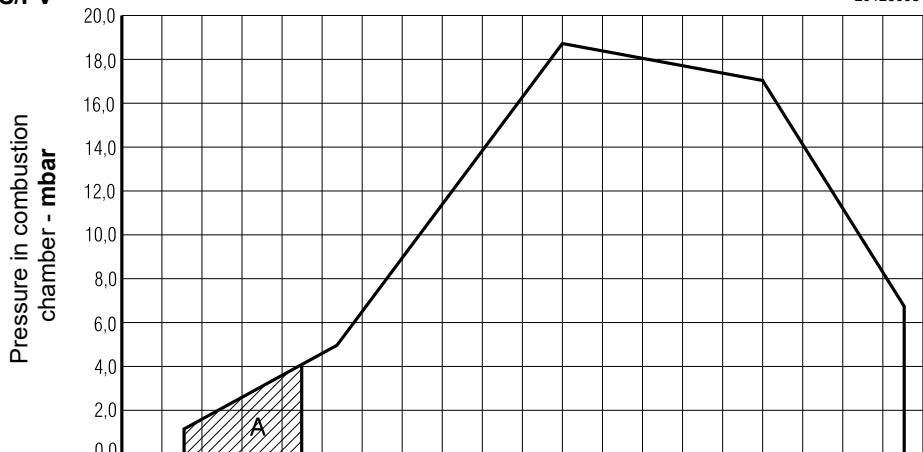
20128696



Thermal power - kW

**RX 1000 S/PV**

20128698



Thermal power - kW

**Fig. 3**

**4.9 Test boiler**

---

The firing rates were set in relation to special test boilers, according to EN 676 regulations.

The burner-boiler combination does not pose any problems if the boiler is EC type-approved.

If, however, the burner is to be used with a commercial boiler that has not been EC approved and/or its combustion chamber dimensions are distinctly smaller, consult the manufacturer.

You are advised to use this burner for boilers with a frontal circulation of the flue gases.

**4.10 Output supplied**

The diagrams allow you to set the power output either using the number of fan revs or using the pressure downstream of the gas valve (Fig. 25 on page 27).

**Example RX 700 S/PV:**

- natural gas G20 PCI 9.45 kWh/Sm<sup>3</sup>
- pressure on point 1 = - 12 mbar (2nd chart)
- burnt output corresponds to 600 kW

Going vertically up the 1st diagram, to intersect the dotted line, you can estimate the value of the number of revs on the left hand y-axis: in this case 3800 rpm.

For an exact reading of the number of revs there is a kit for interfacing with the control box.

**NOTE:**

the burner can operate with LPG without any additional kit, however a different regulation of the gas valve is required.

For the G25 the supplied mixer ring for the G25 needs to be applied as shown in Fig. 12 on page 17.

\* For the **RX 850 S/PV** version, add the mixer ring to the one already installed on the burner as standard.

Model	Ring (mm)
RX 700 S/PV	5
RX 850 S/PV	7 *
RX 1000 S/PV	17

Tab. G

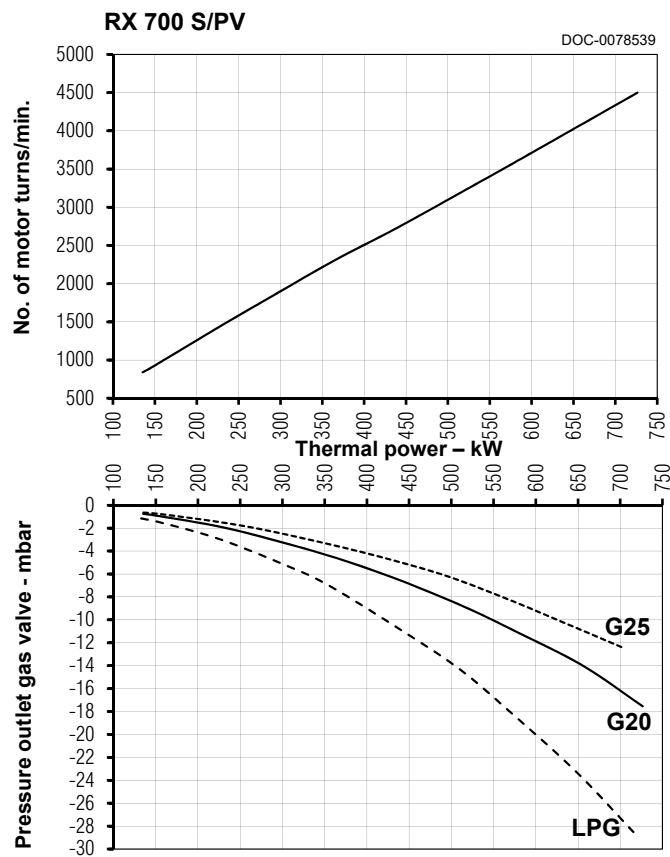


Fig. 4

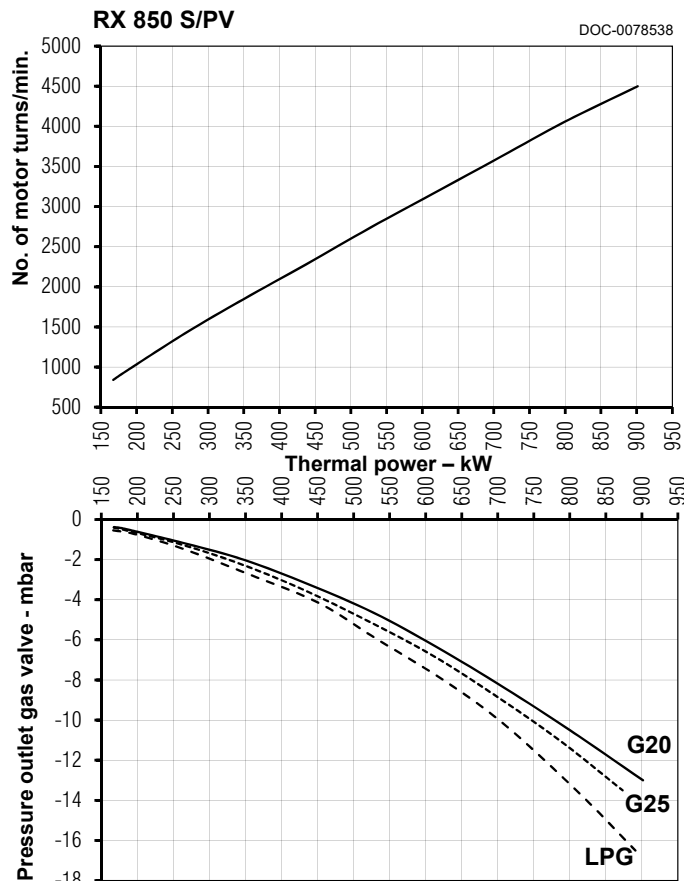


Fig. 5

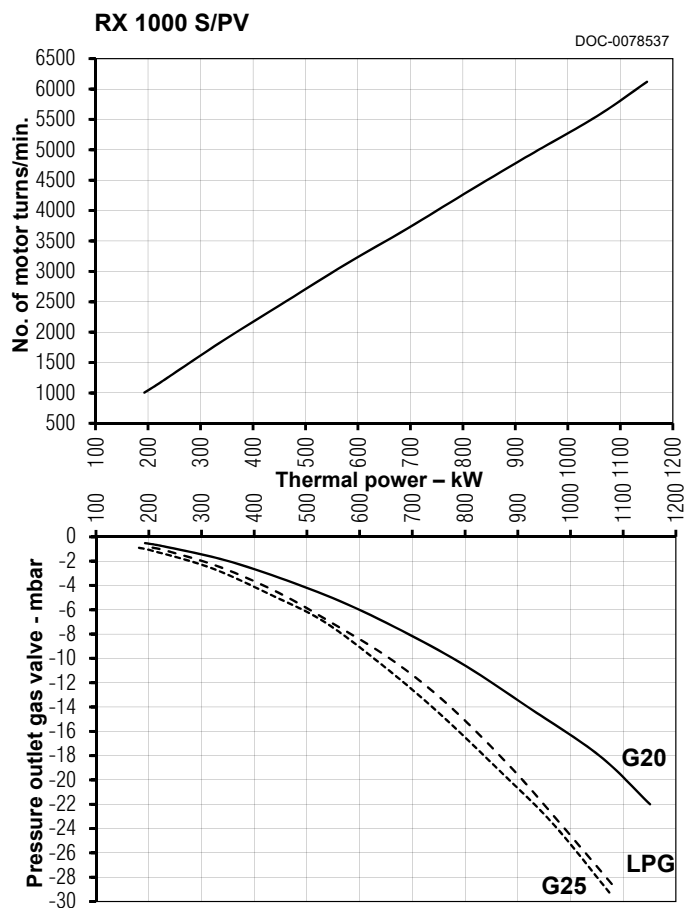
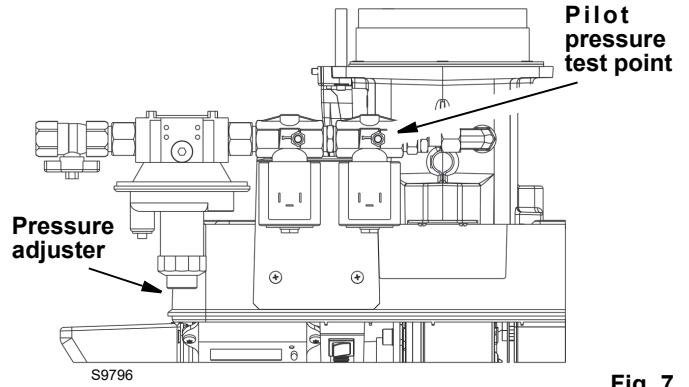


Fig. 6

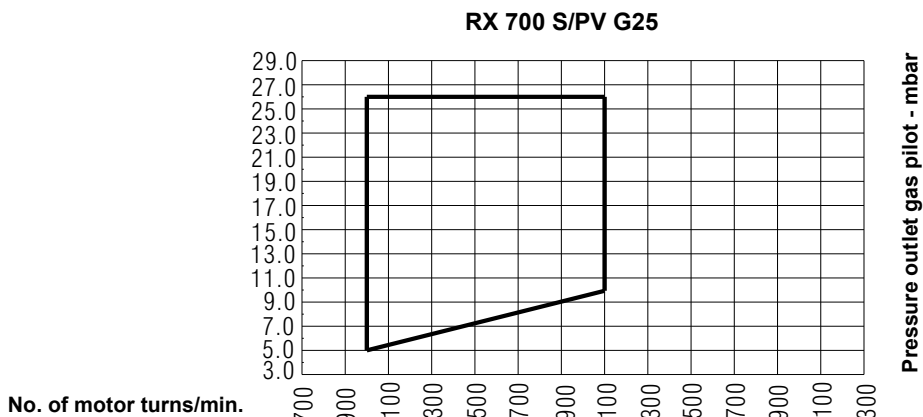
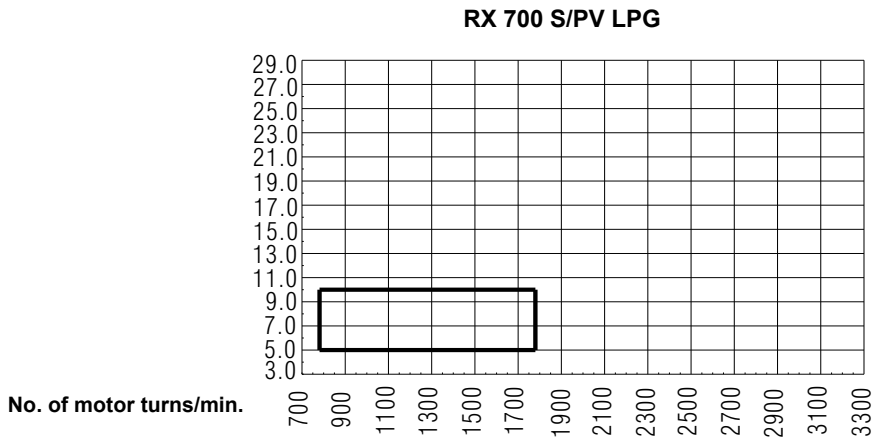
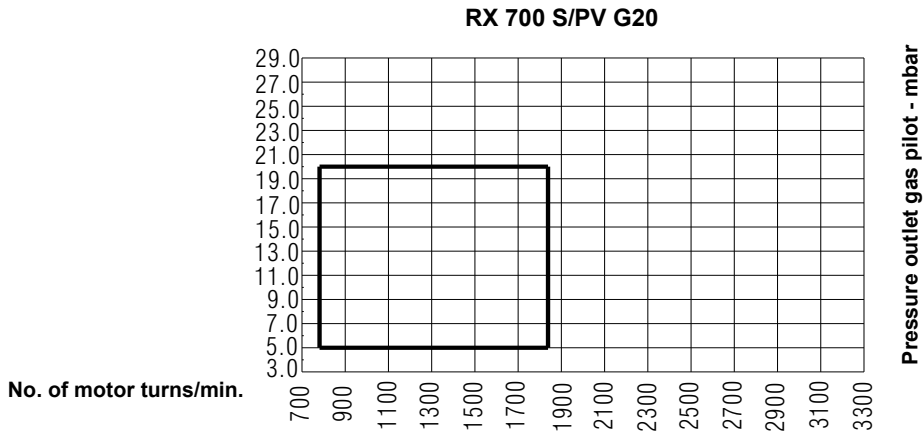
**4.11 Adjustment pilot**

The diagrams allow to choose the optimal gas pressure at the pilot according to the revolutions at the ignition (PO) and the CO<sub>2</sub> to which you want to calibrate it.

The pressure test point to be used is shown in Fig. 7.



**Fig. 7**

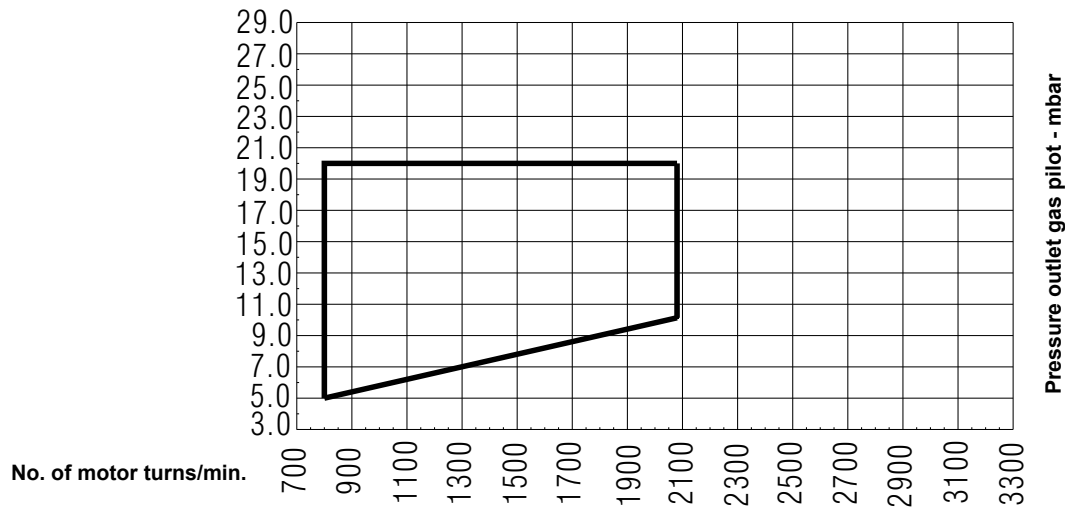


20177452

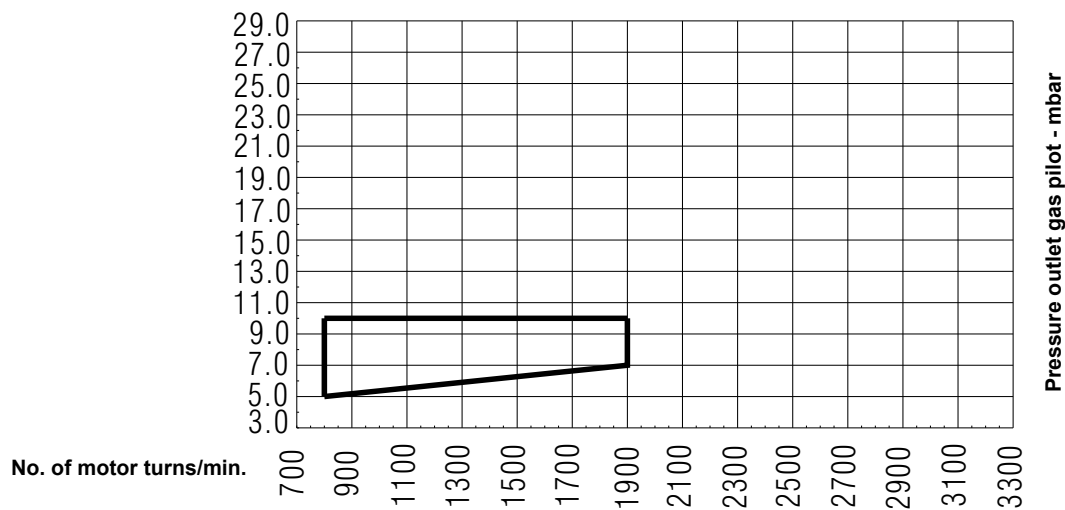
**Fig. 8**



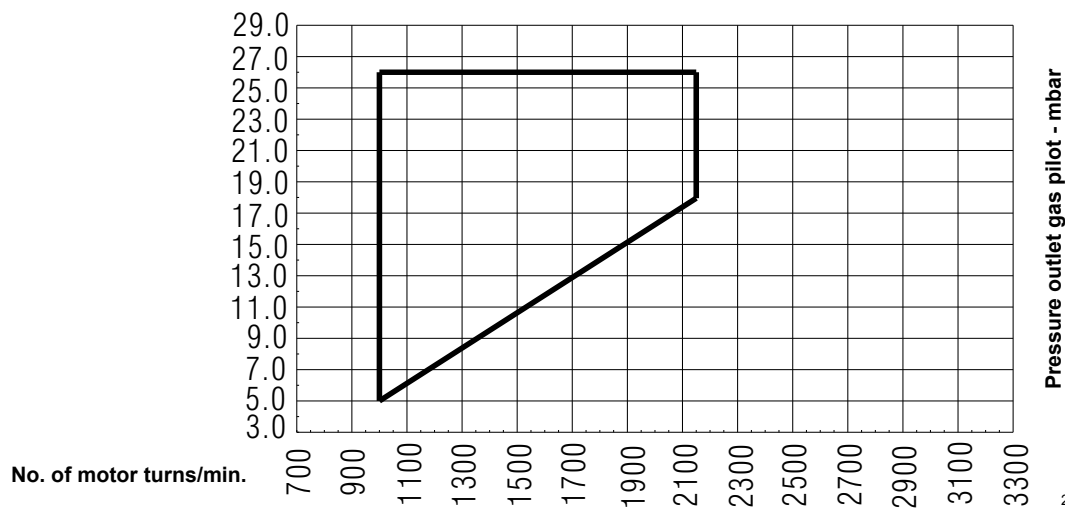
**RX 850 S/PV G20**



**RX 850 S/PV GPL**



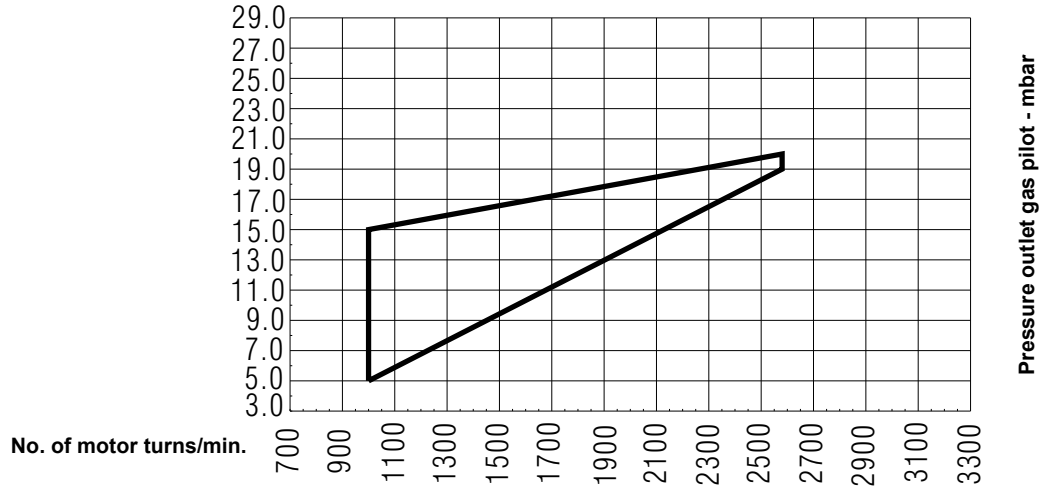
**RX 850 S/PV G25**



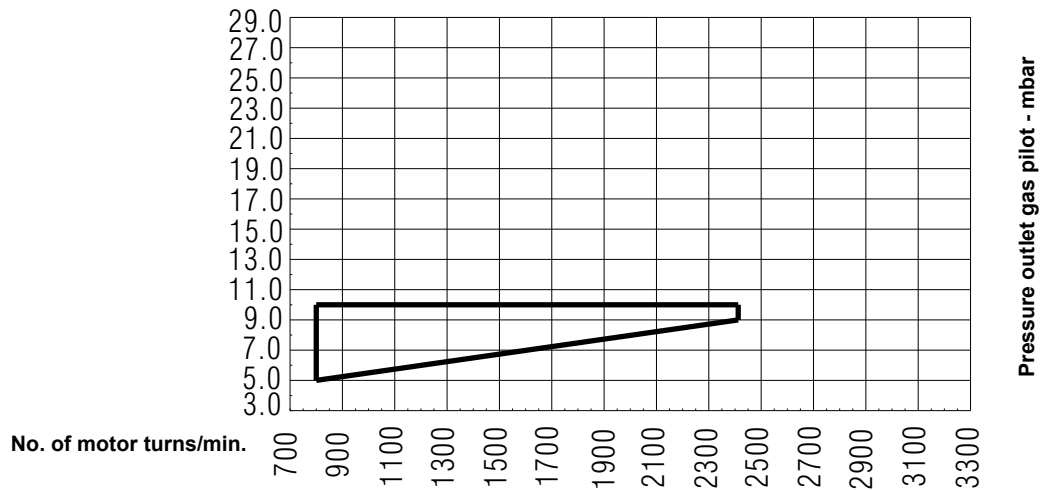
20177456

**Fig. 9**

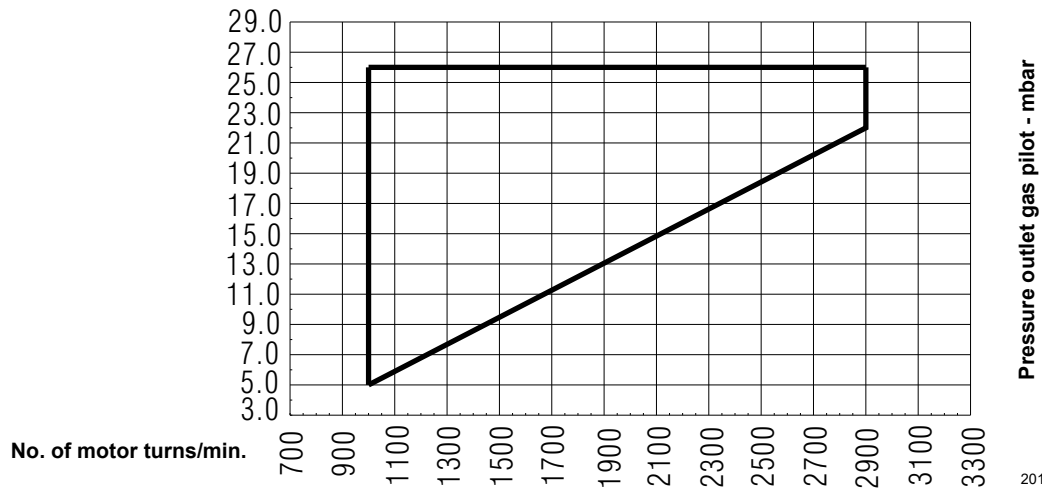
**RX 1000 S/PV G20**



**RX 1000 S/PV GPL**



**RX 1000 S/PV G25**



Pressure outlet gas pilot - mbar

Pressure outlet gas pilot - mbar

Pressure outlet gas pilot - mbar

20177461

**Fig. 10**

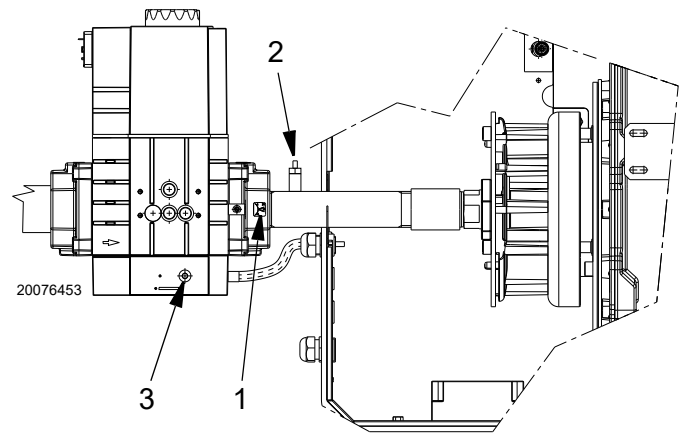
**Valve pre-calibration**

Model	Fuel	V1 - gas max*	V2 - gas min
RX 700	G20	5.5 revs	Middle position
	G25	8.5 revs **	
	G31	2.75 revs	
RX 850	G20	8.5 revs	Middle position
	G25	13.5 revs **	
	G31	5.5 revs	
RX 1000	G20	9 revs	Middle position
	G25	8 revs **	
	G31	4.5 revs	

**Tab. H**

\* Tighten screw 1)(Fig. 11) fully home towards “-” mark, then open it towards “+” mark, following the indications provided in Tab. H.

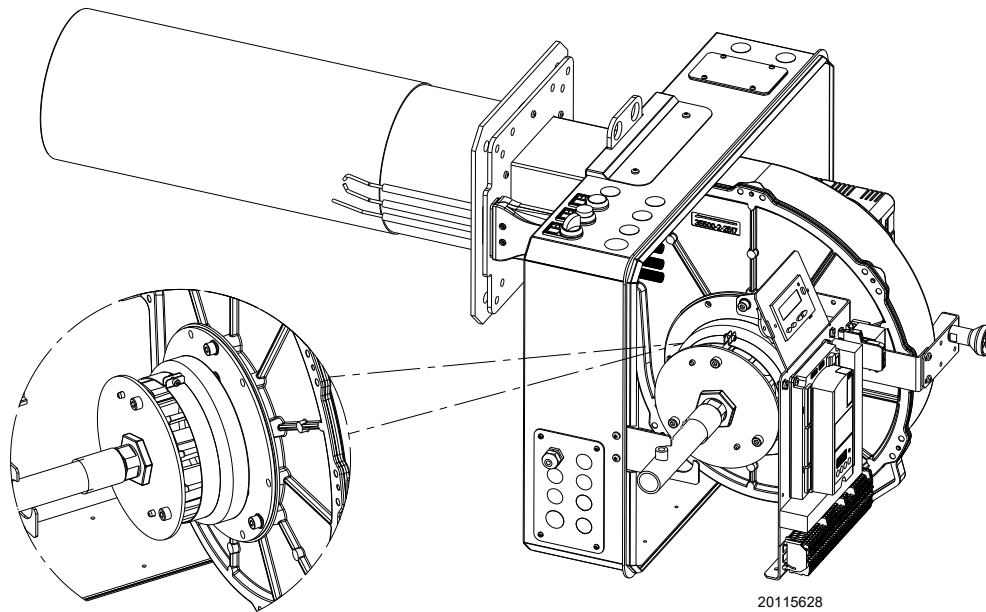
\*\* Install mixer ring for G25 fuel.



**Fig. 11**

Key (Fig. 11)

- 1 Maximum gas flow adjustment (V1)
- 2 Pressure point downstream
- 3 Minimum gas flow adjustment (V2)



**Fig. 12**

**4.12 Burner controls (LME71... with PME71.901...)**

**Warnings**



To avoid accidents, material or environmental damage, observe the following instructions!

The LME71... are safety devices! Avoid opening or modifying it, or forcing its operation.

Riello S.p.A. cannot assume any responsibility for damage resulting from unauthorised interventions! Also the safety notes contained in other chapters of this document must be respected!



The installation and operation of the machine should be carried out only by qualified personnel.

For the purposes of the safety notes in this document, by qualified personnel is meant people authorised to commission, ground and identify electric devices, systems circuits conforming to safety practices and norms.

- All the operations (assembly, installation, maintenance, etc.) should be carried out by qualified personnel.
- Before modifying the wiring in the connection area, fully disconnect the system from the power supply (omnipolar separation). Check the system is not powered and cannot be inadvertently restarted. Failure to do this will lead to the risk of electrocution.
- Ensure protection against the risks of electrocution by providing adequate protection at the terminal connection of the burner (for example, using blind terminals for the inputs and the unused outputs). Failure to do this will lead to the risk of electrocution.
- The space where the program module is placed (Fig. 14) is defined as a connection area and is therefore protected against accidental contact when the module is not present.
- If the housing or the area next to the operator panel is damaged, the unit should be immediately switched off. Failure to do this will lead to the risk of electrocution.
- Press the operator panel buttons only with your hands, without using any equipment or pointed objects. Damage to the operator panel fill leads to the risk of electrocution.

To ensure the safety and reliability of the LME71... system, the following instructions must also be followed:

- Avoid conditions which may promote condensation and humidity.  
Otherwise, before switching on again, make sure that the entire control box is perfectly dry! Failure to do this will lead to the risk of electrocution.
- Static charges must be avoided since they can damage the control box's electronic components when touched.



The formation of condensation, ice and the infiltration of water must absolutely be avoided!

Otherwise, the safety functions could be compromise leading to a risk of electrocution.



S8593

**Fig. 13**

**Program module**



S8673

**Fig. 14**

**Assembly notes**

- Make sure that the relevant national safety standards are respected
- The standard LME7 unit should be fixed with M4 (UNC32) or M5 (UNC24) fixing screws, respecting a maximum tightening torque of 1.8 Nm and using all 3 fixing points.  
The additional assembly surfaces of the housing have the purpose of improving the mechanical stability.  
The should rest on the assembly surface to which the unit is fixed.  
The planarity of the assembly surface should be within a tolerance range of 0.3 mm.

## Installation notes

- Arrange the high voltage ignition cables separately, as far as possible from the control box and the other cables.
- Do not confuse the powered conductors with the neutral ones.
- Install the switches, fuses and grounding in compliance with local regulations.
- The connection diagrams show the burner controls with grounded neutral conductor.
- Make sure that the maximum admissible current of the terminal connections is not exceeded.
- Make sure the cable grommets of the connected cables comply with the relevant standards.
- Do not supply mains voltage to the control box outputs. During the testing of the devices controlled from the burner control (fuel valve, etc), the LME71... should not be connected to the units.
- The mechanical connection between the actuators and the fuel and air control elements, or any other type, should be rigid.
- Make sure there are no short-circuits on the air pressure switch connection lines.

## Electrical wiring to the flame detectors

It is important for signal transmission to be practically free of any disturbances or loss:

- Always separate the detector cables from the other cables:
  - the capacitive reactance of the line reduces the magnitude of the flame signal;
  - use a separate cable.
- Respect the permitted lengths for the cables of the detectors (see Technical Data).
- The ionisation probe powered from the mains is not protected from the risk of electric shocks.
- Position the ignition electrode and the ionisation probe so that the ignition spark cannot form an arc on the probe (risk of electric overload) and that it cannot negatively effect the supervision of the ionisation.

## Description of displays and buttons

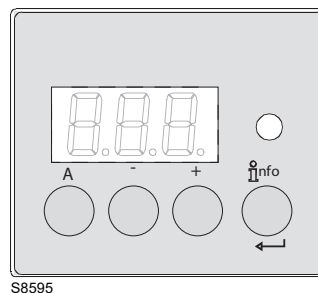


Fig. 15

Button	Function
	<b>Button A</b> <ul style="list-style-type: none"> <li>– Displaying default output</li> <li>– In lockout position: output value at the time of the fault</li> </ul>
	<b>Enter and Info button</b> The reset button (info button) is the key element for resetting the burner control and activating/deactivating the diagnostic functions.
	<b>Button -</b> <ul style="list-style-type: none"> <li>– Displaying flame 2 signal current or displaying phases</li> <li>– In lockout position: MMI phase at the time of the fault</li> </ul>
	<b>Button +</b> <ul style="list-style-type: none"> <li>– Displaying flame 1 signal current or displaying phases</li> <li>– In lockout position: MMI phase at the time of the fault</li> </ul>
	<b>Warning light with 3 colours</b> The warning light with three colours (red - yellow - green) is the key indicator of the visual diagnostics.
	<b>Button + and -: escape function</b> Press the + and - buttons at the same time! <ul style="list-style-type: none"> <li>– No adoption of value</li> <li>– Access to a higher menu level</li> <li>– Keep pressed for &gt;1 second for the backup/reset function</li> </ul>

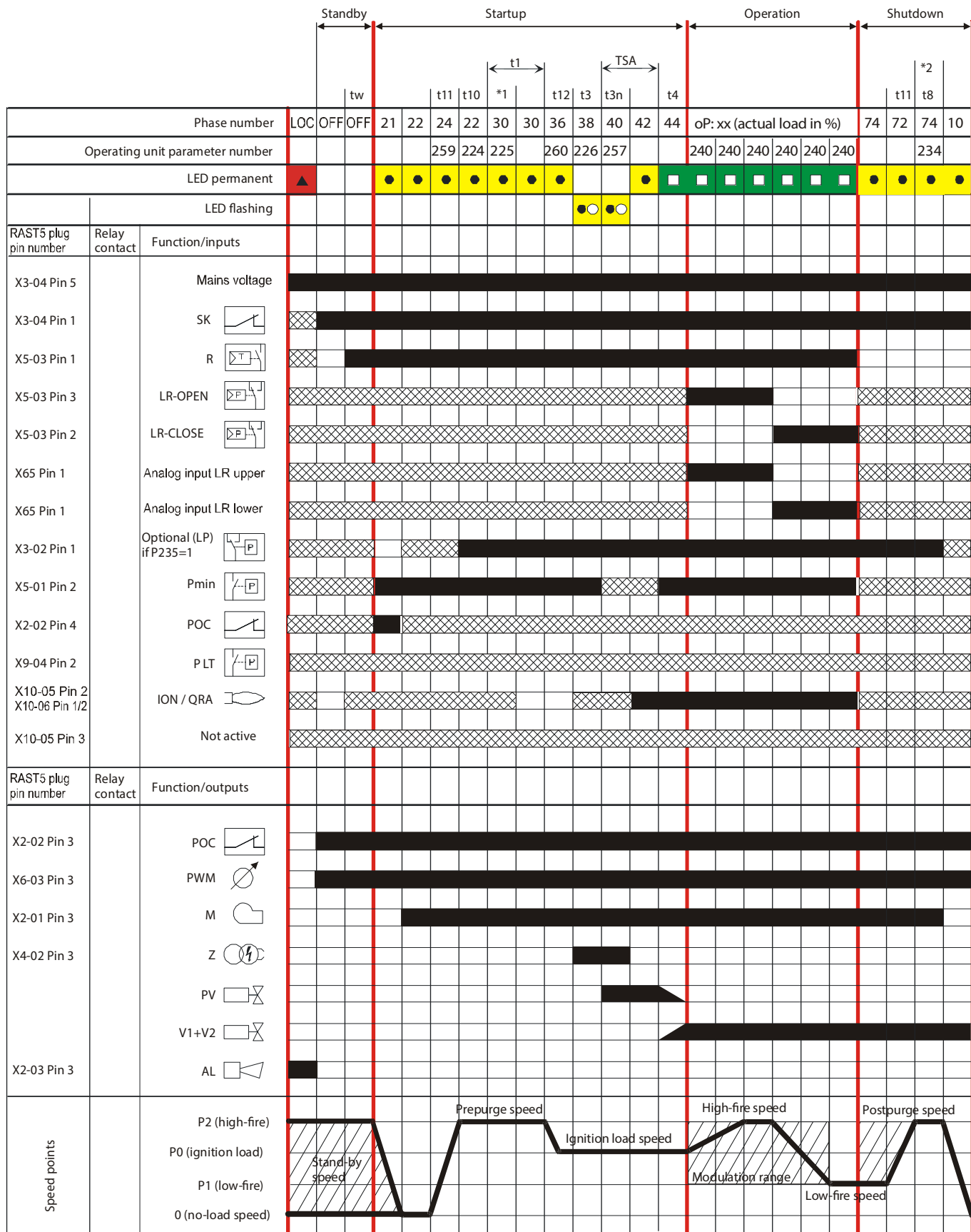
Tab. I

### Technical data

Burner controls LME71...	Mains voltage	AC 230 V
	Mains frequency	50 / 60 Hz +/- 6%
	Power absorption	<10 W, normally
	Primary external fuse	Max. 6.3 A (slow)
	Safety class	I, with components in compliance with II and III, according to DIN EN 60730-1
"Input" terminals values	Voltage	UMains 230 V
	• If the mains voltage drops, there is a safety shut-down from the operating position	< AC 165 V
	• Restarting occurs when the mains voltage exceeds	> AC 195 V
	Input currents and voltages	
	– UeMax	UN +10%
	– UeMin	UN -15%
– IeMax	peak 1 mA (peak value)	
– IeMin	peak 0.5 mA (peak value)	
Voltage detection	– ON	> AC 120 V
	– OFF	< AC 80 V
"Output" terminals Values	<b>Total load on the contacts:</b>	
	Nominal voltage	AC 230 V - 50/60 Hz
	Input current X3-04 unit (safety loop) from:	Max. 5 A
	– fan motor contact maker	
	– ignition transformer	
	– fuel valves	
	<b>Individual contact rating:</b>	
	Fan motor contact maker X2-01 foot 3	
	– Nominal voltage	AC 230 V 50/60 Hz
	– Nominal current	2 A (15A max. 0.5 s)
	– Power factor	Cosφ ≥ 0.4
	Alarm output X2-03/3	
	– Nominal voltage	AC 230 V 50/60 Hz
	– Nominal current	1A
	– Power factor	Cosφ > 0.6
	Ignition transformer X4-02 foot 3	
	– Nominal voltage	AC 230 V 50/60 Hz
	– Nominal current	2A
	– Power factor	Cosφ > 0.4
	Auxiliary output	
	– Nominal voltage	AC 230 V 50/60 Hz
	– Nominal current	1A
	– Power factor	Cosφ > 0.6
	Output relay contact 2 foot 2 X2-09 foot 7	
	– Nominal voltage	AC 230 V 50/60 Hz
	– Nominal current	1A
	– Power factor	Cosφ > 0.4
Fuel valve/pilot valve X7-01 foot 3		
– Nominal voltage	AC 230 V 50/60 Hz	
– Nominal current	1A	
– Power factor	Cosφ > 0.4	
Safety valve X6-03 foot 3		
– Nominal voltage	AC 230 V 50/60 Hz	
– Nominal current	1.5 A	
– Power factor	Cosφ > 0.6	
Cable length	Power supply line from the mains	Max. 100 m (100 pF / m)
Sections	The sections of the mains power supply lines (L, N, and PE) and, if necessary, the safety loop (safety limit thermostat, lack of water, etc.) should be sized for the nominal currents according to the external primary fuse selected. The sections of the other cables should be sized based on the fuse of the internal unit (max. 6.3 AT).	
Environmental conditions	Operation	DIN EN 60721-3-3
	Climatic conditions	Class 3K3
	Mechanical conditions	Class 3M2
	Temperature range	-40...+60°C
	Humidity	< 95% RH

Tab. J





Program sequence



S9220

Fig. 16

Key Fig. 16

AL	Alarm device
AUX	Auxiliary output
Dbr	Lead connection
 (EK1)	Reset button (info button)
EK2	Remote reset button
FSV	Flame signal amplifier
ION	Ionisation probe
K...	Relay contact
LED	Warning lamp with 3 colours
LP	Air pressure switch
LR	Load controller
LR-OPEN	Load controller OPEN
LR-CLOSE	Load controller CLOSED
M	Fan motor
NT	Power supply unit
P LT	Pressure switch valve test
Pmax	Max. pressure switch
Pmin	Min. pressure switch
POC	Closure test
PV	Pilot valve
QRA...	UV flame detector
R	Control thermostat or pressure switch
SA	Actuator
SA-KL	Low flame actuator
SA-NL	High flame actuator
SA-R	Feedback actuator
SA-Z	Actuator CLOSED
SA-ZL	Ignition load actuator
SL	Safety loop
STB	Safety limit thermostat
SV	Safety valve
V1	Fuel valve
V2	Fuel valve
V2a	Fuel valve
W	Limit pressure switch or thermostat
Z	Ignition transformer
µC	µC controller
	Input/output 1 signal (ON)
	Input/output 2 signal (ON)
	Input 1 permitted signal (ON) or 0 (OFF)

Tab. K

Times

TSA	Safety time
tw	Waiting time
t1	Pre-purge time
t3	Pre-ignition time
t3n	Post-ignition time (P257 +0.3 seconds)
Ignition time	6s pilot valve ON - fuel valve OFF 6±12s pilot valve ON - fuel valve ON >12s pilot valve OFF - fuel valve ON
t4	Interval: end of safety time load controller release
t8	Post-purge time
t10	Specified time air pressure switch state message (time out)
t11	Opening time of actuator (time out)
t12	Closing time of actuator (time out)

Tab. L



Phases key (Fig. 16 on page 21):

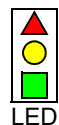
Phase number	Function
LOC	Switching off phase lockout
OFF	Standby, awaiting heat request
oP	Part 1: Load controller request OPEN
	Part 2: fan motor modulation speed towards high flame
	Part 3: high flame reached
	Part 4: load controller request CLOSED
	Part 5: fan motor modulation speed towards low flame
	Part 6: low flame reached
10	Settling time, fan motor standby speed
21	Safety valve ON, air pressure switch in load absence position
	Check that the POC is closed and that the fan motor speed has been reduced to 0
22	Part 1: fan motor ON
	Part 2: specified time air pressure switch Message (timeout), air pressure switch stabilisation
24	Settling time, fan motor pre-purging speed
30	Part 1: pre-purging time without flame simulation test
	Part 2: pre-purging time with flame simulation test (2.1 seconds)
36	Stabilisation time at ignition speed
38	Spark pre-ignition time
40	Post-ignition time, parameter 257 + 0.3 seconds
42	Flame detection
44	Interval: end of time for safety ignition and load controller reset (modulation start)
72	Settling time speed, fan motor pre-purging speed
74	Part 1: the operation is finished, check that the post-purging has been programmed
	Part 2: post-purging time
90	Min pressure switch open--> switching off safely
*1	Test valve, if P241 = 1 after each ON, lockout or P234 (post-purging time) = 0 seconds
*2	Test valve, if P241 = 1 and P234 (post-purging time) >0 seconds

Tab. M

## 4.12.1 Indication of the diagnostic mode



The reset button (info button) is the key element for resetting the burner control and activating/deactivating the diagnostic functions.



The multi-colour indicator lamp is the key indicator of the visual diagnostics.

Both the reset button and the indicator lamp are on the control panel.

There are 2 diagnostic options:

- 1 Visual diagnostics: Indication of the operating status or diagnostics of the cause of the fault
- 2 Diagnostics: From BCI to AZL2... operating and display unit

Visual diagnostics:

During normal operation, the various operating conditions are shown in the form of colour codes based on the table shown below (Tab. N).

### Indication of the operating status

During start-up, the status indication is based on Tab. N:

Table of colour codes for multi-colour indicator lamp

Status	Colour code	Colour
Standby time, other waiting modes	○.....	OFF
Ignition phase, controlled ignition	●○●○●○●○	blink yellow
Operation, flame o.k.	■.....	Green
Operation, flame not o.k.	■○■○■○■○	Green blink
Burner start-up extraneous light	■▲■▲■▲■▲	Green-Red
Undervoltage	●▲●▲●▲●▲	Yellow - Red
Fault, alarm	▲.....	Red
Output error code (see error code Tab. Y on page 64)	▲○▲○▲○▲○	Red blinking
Diagnostics interface	▲▲▲▲▲▲▲▲	Red blinking light
Heat request	●.....	Yellow
New program board	●●▲●●▲●●	Yellow - Red

Tab. N

Key (Tab. N)

- ..... Always on
- OFF
- ▲ Red
- Yellow
- Green

**5 Installation**

**5.1 Notes on safety for the installation**

After carefully cleaning all around the area where the burner will be installed, and arranging the correct lighting of the environment, proceed with the installation operations.



All the installation, maintenance and disassembly operations must be carried out with the electricity supply disconnected.



The installation of the burner must be carried out by qualified personnel, as indicated in this manual and in compliance with the standards and regulations of the laws in force.



Combustion air inside the boiler must be free from hazardous mixes (e.g.: chloride, fluoride, halogen); if present, it is highly recommended to carry out cleaning and maintenance more frequently.

**5.2 Handling**

The burner packaging includes a wooden platform, it is therefore possible to move the burner (still packaged) with a transpallet truck or fork lift truck.



The handling operations for the burner can be highly dangerous if not carried out with the greatest attention: keep any unauthorised people at a distance; check the integrity and suitability of the available means of handling. Check also that the area in which you are working is empty and that there is an adequate escape area (i.e. a free, safe area to which you can quickly move if the burner should fall). When handling, keep the load at not more than 20-25 cm from the ground.



After positioning the burner near the installation point, correctly dispose of all residual packaging, separating the various types of material.



Before proceeding with the installation operations, carefully clean all around the area where the burner will be installed.

**5.3 Preliminary checks**

**Checking the consignment**



After removing all the packaging, check the integrity of the contents. In the event of doubt, do not use the burner; contact the supplier.



The packaging elements (wooden cage or cardboard box, nails, clips, plastic bags, etc.) must not be abandoned as they are potential sources of danger and pollution; they should be collected and disposed of in the appropriate places.

R.B.L.	A		B	C
D	E			F
GAS-KAASU	<input checked="" type="checkbox"/>	G	H	J
GAZ-AEPIO		G	H	K
I				
RIELLO S.p.A. I-37045 Legnago (VR)				L CE

20116021

**Fig. 17**

**Checking the characteristics of the burner**

Check the identification label of the burner (Fig. 17), showing:

- A the burner model;
- B the burner type;
- C the cryptographic year of manufacture;
- D the serial number;
- E the data for electrical supply and the protection level;
- F maximum electrical power consumption;
- G the types of gas used and the relative supply pressures;
- H the data of the burner's minimum and maximum output possibilities (see Firing rate).

**Warning.** The burner output must be within the boiler's firing rate;

- I the category of the appliance/countries of destination;
- J Maximum current drawn;
- K Burner weight;
- L CE number.



A burner label, or any other component, that has been tampered with, removed or is missing, prevents the definite identification of the burner and makes any installation or maintenance work difficult

**5.4 Operating position**



- The burner is designed to operate only in positions **1, 2, 4** and **5** (Fig. 18).
- Installation **1** is preferable, as it is the only one that allows the maintenance operations as described in this manual.
- Installations **2, 4** and **5** allow operations to be performed, but make maintenance and inspection of the combustion head more difficult.
- All the positions require the installation of the gas valve with coils facing upwards or horizontally (Fig. 18).



- Any other position could compromise the correct operation of the appliance.
- Installation **3** is prohibited for safety reasons.
- Installation with the coils pointing downwards is absolutely forbidden.

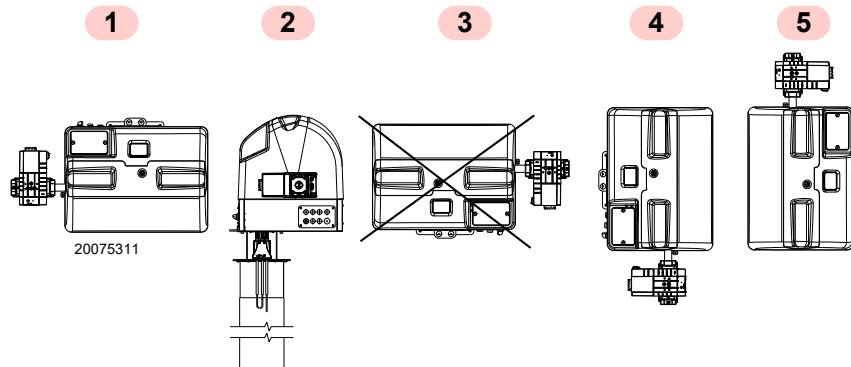


Fig. 18

**5.5 Preparing the boiler**

**5.5.1 Boring the boiler plate**

Pierce the closing plate of the combustion chamber, as in Fig. 19. The position of the threaded holes can be marked using the thermal insulation screen supplied with the burner.

mm	A	B	C	D	E
RX 700 S/PV	240	325 ÷ 275	M10	135	75
RX 850 S/PV	240	325 ÷ 275	M10	135	75
RX 1000 S/PV	240	325 ÷ 275	M10	135	75

Tab. O

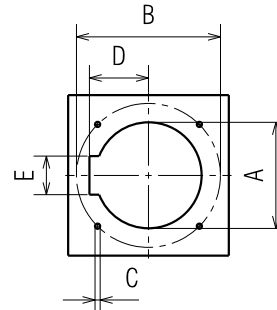


Fig. 19

**5.5.2 Head length**

The length of the head must be selected according to the indications provided by the manufacturer of the boiler, and in any case the combustion area must be greater than the thickness of the boiler door complete with refractory.



The burners cannot be used on flame inversion boilers.

It is possible to insert a protective device made of refractory material between the combustion head and the boiler refractory. This protective device must allow the blast tube to be taken out (Fig. 20).



Do not insert the protection in line with the electrode unit, as this would compromise its good operation.

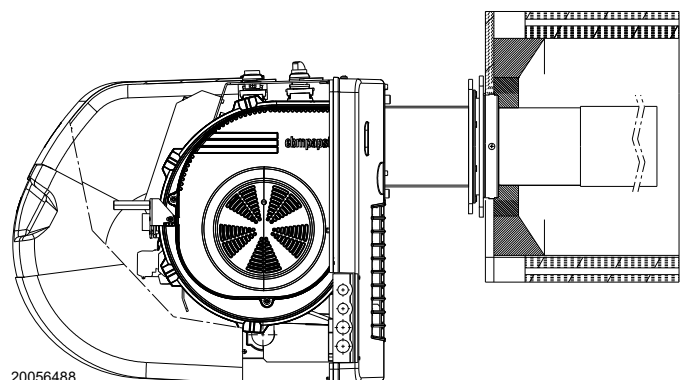


Fig. 20

mm	Non-combustion area
RX 700-850-1000 S/PV	180

Tab. P

### 5.6 Securing the burner to the boiler

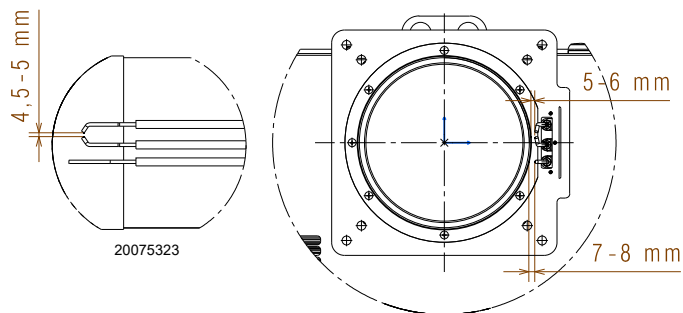


Provide an adequate lifting system.



**WARNING**

The seal between burner and boiler must be air-tight.



**Fig. 21**

#### 5.6.1 Standard head version

The burners are supplied with the combustion head and electrodes unit ready assembled.



**WARNING**

Before installing the burner on the boiler, make sure the probe and electrodes are positioned correctly as in Fig. 21.

- Fasten main train unit 20)(Fig. 22) to mixer 18)(Fig. 22) by means of supplied tube 26)(Fig. 22).
- Insert the pilot train 27)(Fig. 23) on connector 28)(Fig. 23) and tighten the nut fully home.
- Check that the sealing ogive is inside the connector.
- Fasten pilot train 27)(Fig. 23) with screws 29)(Fig. 23).



**WARNING**

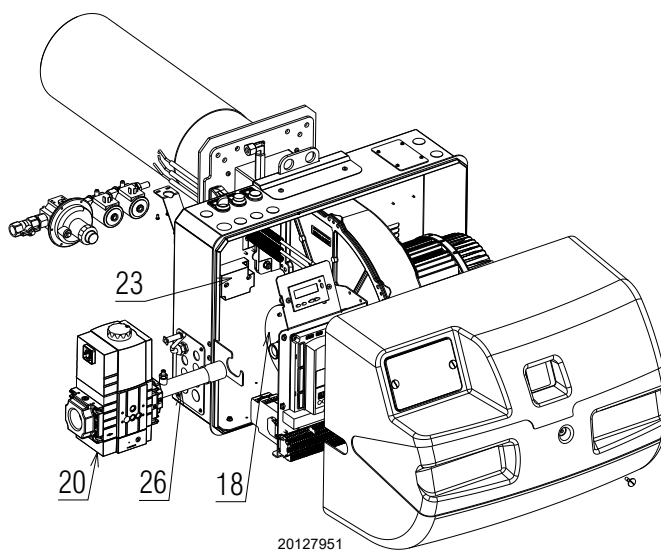
Use a suitable sealant and check the general gas seal during operation, in particular with respect to tube 26)(Fig. 22) and connector 28)(Fig. 23).

- Tighten the studs 2)(Fig. 24) to the plate 1)(Fig. 24).
  - Position the refractory gasket 3)(Fig. 24).
  - Fix the flange 5)(Fig. 24) to the boiler plate and tighten the nuts 4)(Fig. 24).
- During this operation, take care not to touch the electrode unit.

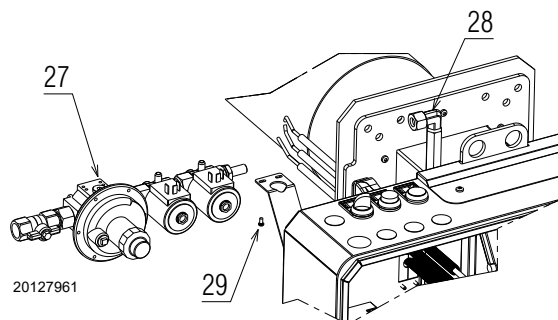


**WARNING**

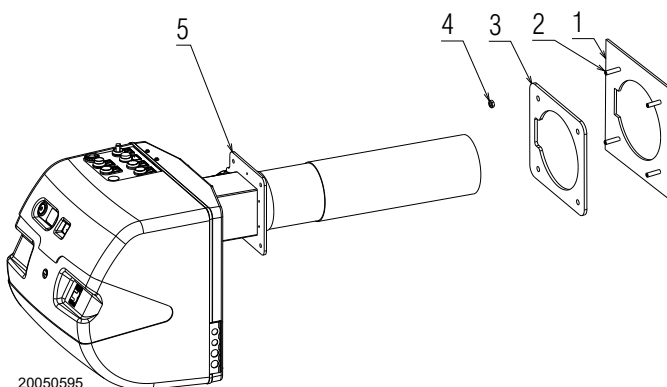
The seal of the burner-boiler and electrode unit must be hermetic.



**Fig. 22**



**Fig. 23**



**Fig. 24**

**5.7 Fuel supply**



Explosion danger due to fuel leaks in the presence of a flammable source.

Precautions: avoid knocking, attrition, sparks and heat.

Make sure the fuel interception tap is closed before performing any operation on the burner.



**WARNING**

The fuel supply line must be installed by qualified personnel, in compliance with current standards and laws.

The burners are teamed with one-piece pneumatic proportioning gas valves, via which the amount of gas delivered, and hence the output produced, can be modulated.

A signal reporting pressure detected in the air circuit is carried to the pneumatic gas valve, which delivers an amount of gas in proportion to the airflow produced by the fan.

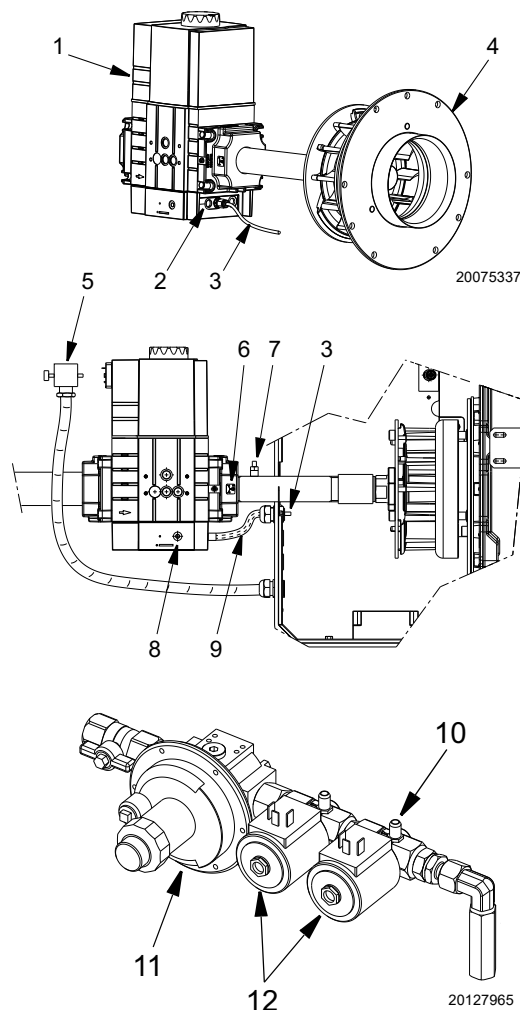
**Air/gas mixer**

Gas and combusive air are mixed inside the purging circuit (mixer), starting from the intake inlet.

Through the gas train, fuel is introduced into the intake air current and optimal mixing commences with the aid of a mixer.

**NOTE:**

The compensation pipe 3)(Fig. 25) allows compensation to occur for accidental blockage of the suction line due to a reduction in the gas delivered.



**Fig. 25**

**Key (Fig. 25)**

- 1 Gas valve
- 2 Quick coupling
- 3 Compensation pipe (T)
- 4 Air/gas mixer in the circuit of the suction line
- 5 Electronic valve connection (XV1)
- 6 Maximum gas flow adjustment (V1)
- 7 Downstream pressure test point
- 8 Minimum gas flow adjustment (V2)
- 9 Metallic protective device
- 10 Pilot supply pressure
- 11 Pressure adjuster
- 12 Safety valves

### 5.7.1 Gas train

This has been type-approved together with the burner, in accordance with regulation EN 676, and is supplied as standard (Fig. 26).



Make sure that the gas train is properly installed by checking for any fuel leaks.

#### Gas train installation



Disconnect the electrical power using the main system switch.



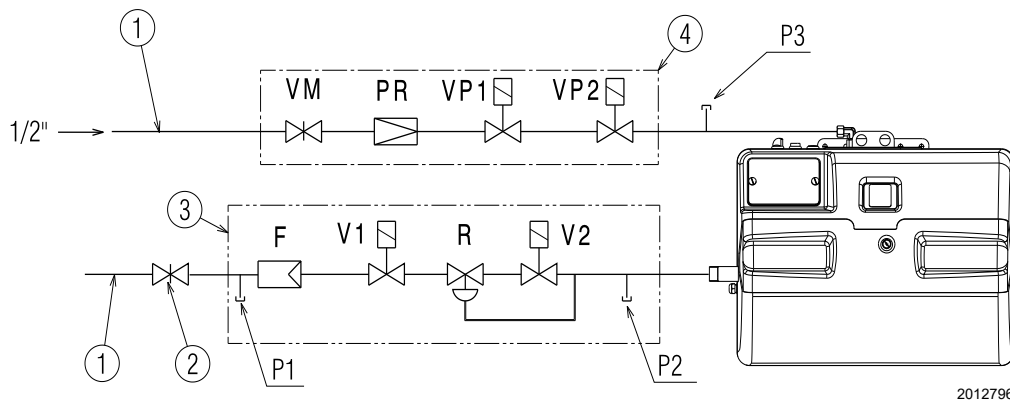
Check that there are no gas leaks.



Beware of train movements: danger of crushing of limbs.



The operator must use appropriate tools for installation.



20127964

Fig. 26

#### Key (Fig. 26)

- 1 Gas input pipe
- 2 Manual valve
- 3 Valve including:
  - filter (replaceable) (F)
  - working valves (V1 - V2)
  - pressure adjuster (R)
- 4 Pilot valve including:
  - manual valve (VM)
  - pressure adjuster (PR)
  - safety valves (VP1 - VP2)
- P1 Pressure upline of the filter
- P2 Downstream pressure of valve
- P3 Downstream pressure of pilot

## 5.8 Electrical wiring

## Notes on safety for the electrical wiring



DANGER

- The electrical wiring must be carried out with the electrical supply disconnected.
- Electrical wiring must be made in accordance with the regulations currently in force in the country of destination and by qualified personnel. Refer to the wiring diagrams.
- The manufacturer declines all responsibility for modifications or connections different from those shown in the wiring diagrams.
- Check that the electrical supply of the burner corresponds to that shown on the identification label and in this manual.
- The burner has been type-approved for intermittent use. This means they should compulsorily be stopped at least once every 24 hours to enable the control box to perform checks of its own start-up efficiency. Normally, burner stopping is guaranteed by the boiler's thermostat/pressure switch.
- If this is not the case, a time switch should be fitted in series to TL to stop the burner at least once every 24 hours. Refer to the wiring diagrams.
- The electrical safety of the device is obtained only when it is correctly connected to an efficient earthing system, made according to current standards. It is necessary to check this fundamental safety requirement. In the event of doubt, have the electrical system checked by qualified personnel. Do not use the gas tubes as an earthing system for electrical devices.
- The electrical system must be suitable for the maximum power absorption of the device, as indicated on the label and in the manual, checking in particular that the section of the cables is suitable for that level of power absorption.
- For the main power supply of the device from the electricity mains:
  - do not use adapters, multiple sockets or extensions;
  - make provisions for an omnipolar switch with a gap between the contacts of at least 3 mm (over-voltage category III), as required by current safety regulations.
- Do not touch the device with wet or damp body parts and/or in bare feet.
- Do not pull the electric cables.

Before carrying out any maintenance, cleaning or checking operations:

Before carrying out any maintenance, cleaning operations or controls, always find and disconnect the burner's electrical supply and find and close the manual shutoff valve on the burner's gas feeding.



DANGER

Turn off the burner's power supply using the main system switch.



DANGER

Turn off the fuel interception tap.



DANGER

Avoid condensate, ice and water leaks from forming.

If the cover is still present, remove it and proceed with the electrical wiring according to the wiring diagrams.

Use flexible cables in compliance with the EN 60 335-1 standard.



After carrying out maintenance, cleaning or checking operations, reassemble the cover and all the safety and protection devices of the burner.

**NOTE:**

Only for models RX 700-850 S/PV.

To meet the regulatory limits set by the EN 55014-1 Directive regarding electromagnetic compatibility we recommend using a shielded multi-core cable for command/control signals (like thermostats, signalling and remote reset).

The cable's shielding should be grounded on both sides.

**NOTE:**

It is not necessary to use a shielded cable for the burner's power supply.

### 5.8.1 Supply cables and external connections passage

All the cables to be connected to the burner must be threaded through cable grommets. The cable grommets can be used in various ways, the following is one example.

Fix the cables to the support bracket using clips.

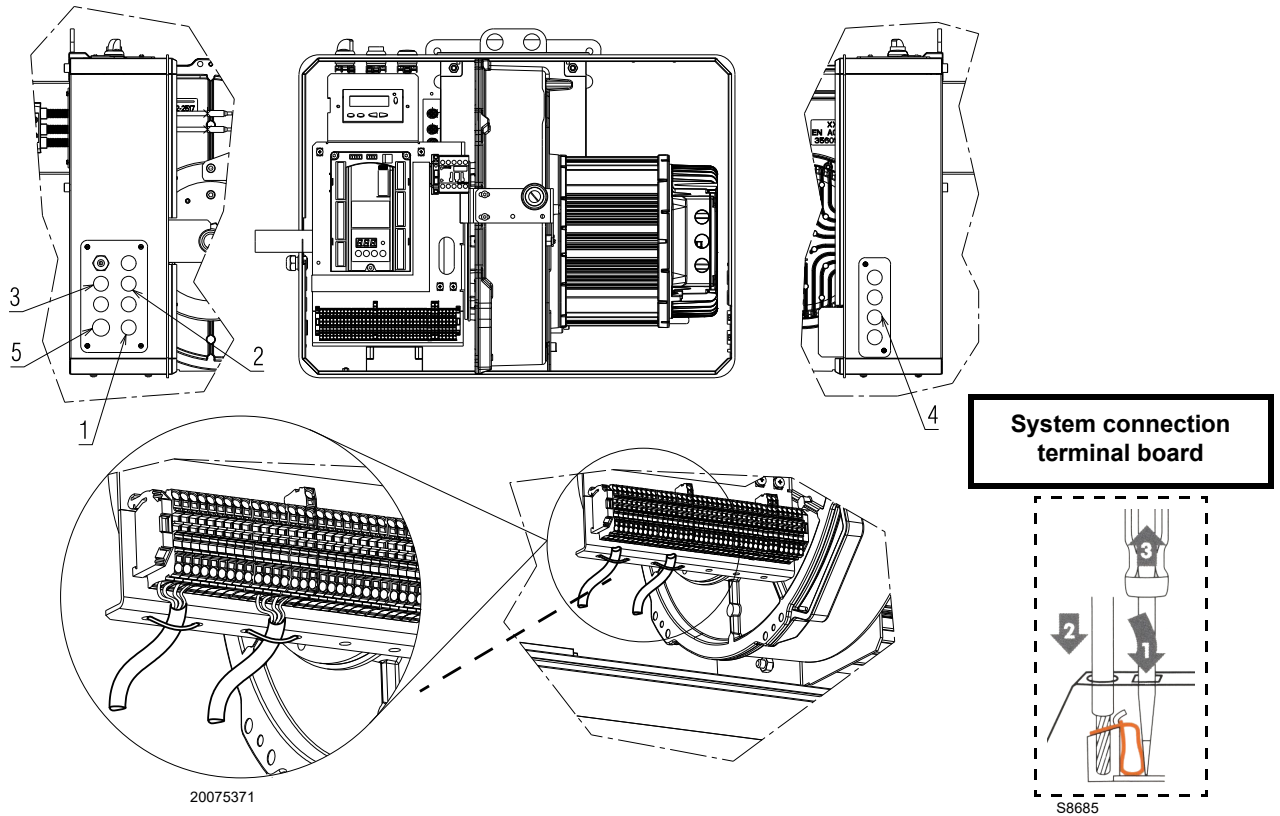


Fig. 27

Key (Fig. 27)

- 1 Single-phase power supply, thermostat/pressure switch TL
- 2 Thermostat/pressure switch
- 3 Consent/safety
- 4 Available
- 5 Three-phase power supply

#### Cable length

Power supply line from the mains	Max. 100 m (100 pF/m)
Load controller X5-03	Max. 30 m (100 pF/m)
Safety loop	Max. 30 m (100 pF/m)
Remote reset (lay separated cable)	Max. 30 m (100 pF/m)
Other lines	Max. 30 m (100 pF/m)

Tab. Q



**5.8.2 Opening sequence of the fuse-holder**

In the event of a fault or control of the fuse-holder, proceed as follows to remove or change the fuse:



**DANGER**

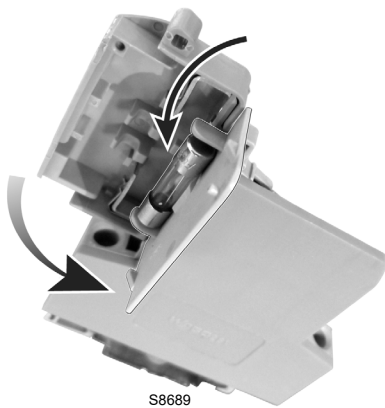
Turn off the burner's power supply using the main system switch.

Release as in Fig. 28.



**Fig. 28**

Open the component side (control or replacement) as indicated in Fig. 29.



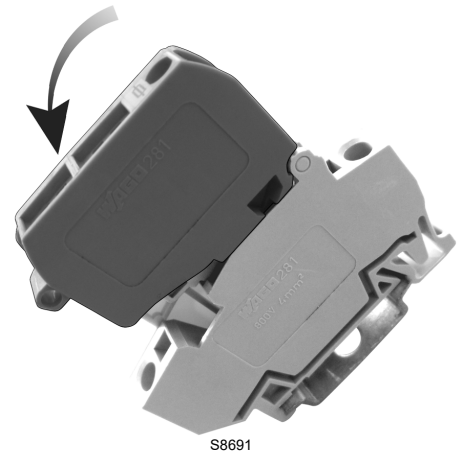
**Fig. 29**

Close the component side (Fig. 30).



**Fig. 30**

Hook the component side (Fig. 31).



**Fig. 31**



**WARNING**

After installing, check all the safety conditions: line leaks, tightening, adequateness and stability of the main flame in all the permitted firing rates and with sudden change of the firing rate, performances and gas sealing of all the safety shutoff valves.

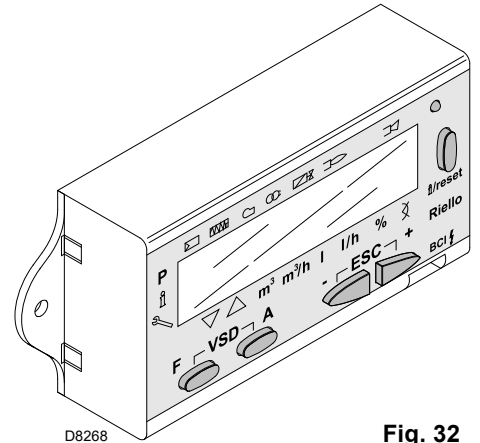
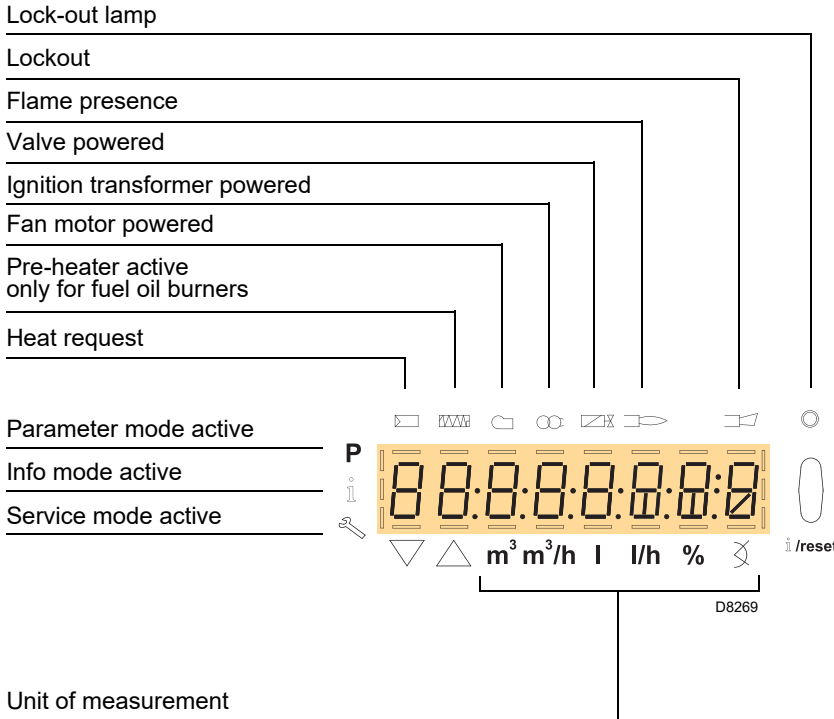


Sheets of the cover, cases and protections should always be in their place except during maintenance and repair work.

**6 Calibration and operation**

**6.1 Operator panel with LCD AZL 21... display for control box LME 71... with PME 71.901...**

**Description of the symbols**



**Fig. 32**

**Key to units of measurement**

- m<sup>3</sup> cubic metre
- m<sup>3</sup>/h cubic metre/hour
- l litre
- l/h litre/hour
- % size as percentage

The unit of measurement of the size visualised is identified by the presence of a dash in the corresponding unit of measurement.

**Description of the keys**

Key	Function
	- Access to Parameters Mode <b>P</b> (press, at the same time, <b>F</b> and <b>A</b> plus <b>-</b> or <b>+</b> )
	- <b>Enter</b> in Parameters Mode - <b>Reset</b> in the event of a lockout - Access to a lower level of the menu - In Service mode and Info mode, allows: * the selection of the parameter (flashing symbol) (press the key for <1s) * access to a lower level of the menu (press the key for 1 - 3 s) * access to a higher level of the menu (press the key for 3 - 8 s) * access to another mode (press the key for > 8 s)
	- Reduction of value - Access to a lower point of the modulation curve - Scrolling of the parameter list
	- Increase of value - Access to a higher point of the modulation curve - Scrolling of the parameter list
	<b>Exit function (ESC)</b> (press <b>-</b> and <b>+</b> simultaneously) - Non confirmation of the value - Access to a higher level of the menu

Technical data

Operation and display unit		
Unit general information	Operating voltage	DC 5V
	Power absorption	<50 mW (normally)
	Protection level	
	- AZL21...	IP40 according to IEC529
	Safety class	II according to DIN EN 60730-1
	Housing	
- Material	PC and PC / ABS	
- Colour	RAL 7035 (light grey)	
Fire protection class		
- Transparent parts of the housing	According to UL94 V2 (PC)	
- Coloured parts of the housing	According to UL94 V0 (PC / ABS)	
Inputs/outlets	BCI interface with female RJ11	For Siemens burner commands
Ambient conditions	Operation	DIN EN 60721-3-3
	Climatic conditions	Class 3K3
	Mechanical conditions	Class 3M3
	Temperature range	-20...+60°C
	Humidity	< 95 % RH

**The formation of condensation, ice and the infiltration of water must absolutely be avoided!**

6.2 Operator panel with LCD display

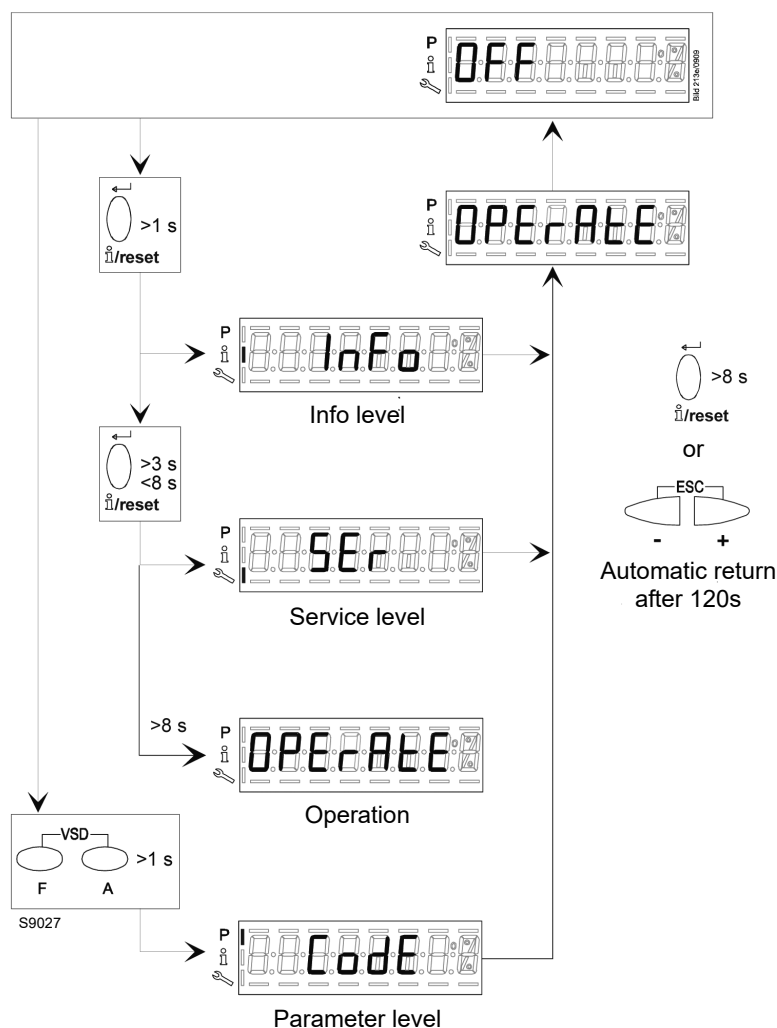


Fig. 33

**6.3 Visualisation and programming modes**

The operator panel, and especially the display visualisation, has 4 working modes:

- Normal Mode
- Info Mode (**InFo**)
- Service Mode (**Ser**)
- Parameter Mode (**PARa**)

The information for accessing and operating at the various levels is given below.

**Normal Mode**

Visualises the operation conditions and allows you to modify the operation point of the burner manually.

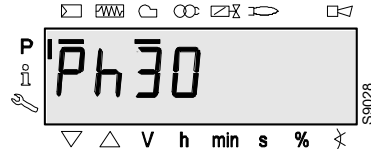
It does not require any use of the keys of the operator panel.

It allows access to the other visualisation and programming modes.

Some examples in the standard conditions are given below.

**Display during starting/stopping.**

Displaying the program phases.



**Fig. 35**

The unit is in phase 30. The regulator requires heat.

The bar is displayed under the symbols and .

The individual phases of the program and the components controlled are displayed according to the sequence of the program.

**6.3.1 Operation**



**WARNING**

Eventual modifications to the parameters and the settings should be set and saved only in the unit's internal memory.

To save the modified settings in the PME7... program module, the backup should be activated manually. Otherwise there is the risk of losing the safety functions.



**WARNING**

At the first start-up or after replacing the program module, the sequence of the functions and the parameter settings should be checked when the restore process has finished. Otherwise there is the risk of losing the safety functions.



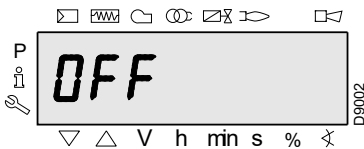
**WARNING**

If the parameters need to be changed, a backup copy must be made! Otherwise there is the risk of losing the safety functions.

**Normal display**

Normal display is the standard display during normal operation, which is the higher menu level. From normal display it is possible to pass to the Info, Service or Parameters level.

Display in standby mode.



**Fig. 34**

The unit is in standby mode.

**Note:**

**OFF flashes when the manual switching off function or the manual control are active, and when the regulator is off.**

### 6.3.2 Displaying the operating position

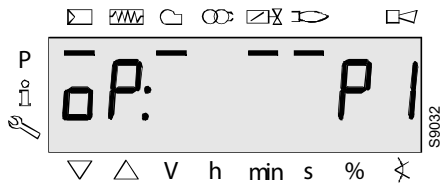


Fig. 36

Displaying **oP: P1** means the 1st stage.  
The display after **oP** is specific to the unit.

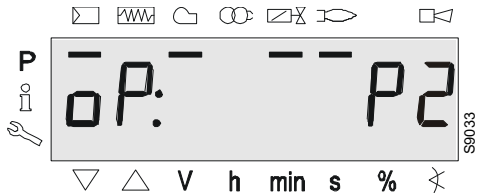


Fig. 37

Displaying **oP: P2** means the 2nd stage.  
The display after **oP** is specific to the unit.

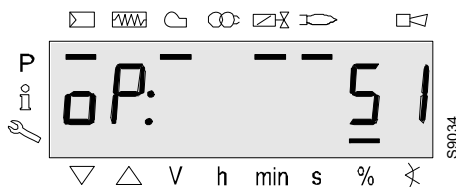


Fig. 38

Displaying **oP**: means modulating operation.  
The display after **oP**: is specific to the unit.  
The value shown on the display corresponds to the percentage of the speed.  
0 RPM = displaying 0%  
RPM MAX = displaying 100%

### 6.3.3 Fault messages, display errors and information

#### Displaying errors (faults) with lockout



Fig. 39

The display shows **Loc**. The bar under the fault status  
The message is displayed.

The unit is in a lockout position. The corresponding error code is displayed (see chapter Table of blink codes).

Example: Error code 7.

#### Reset

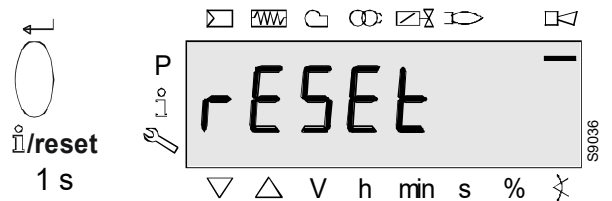


Fig. 40

Pressing "i/reset" for 1 second displays **rESEt** on the display. When the button is released, the base unit is reset.

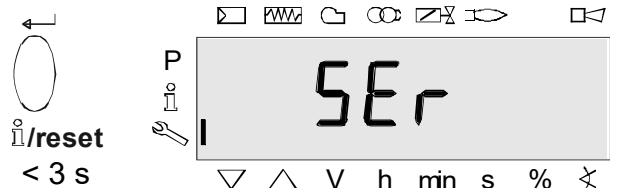
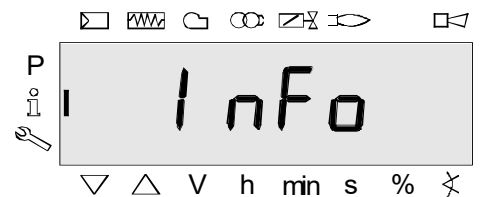


Fig. 41

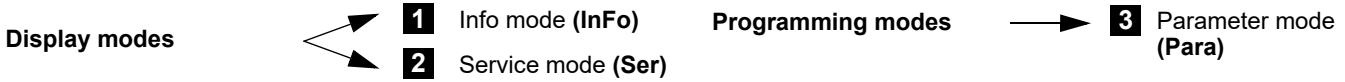
Pressing "i/reset" for > 3 seconds, displays **InFo**, **SEr** and then **OPERAtE**.

When the button is released, the base unit is reset.

#### Note:

for the meaning of the error and the diagnostic codes, see "List of error codes with operation using AZL21... Display" on page 63. When an error has been acknowledged, it can still read in the chronology of errors.

From Normal mode, using the keys of the Operator Panel, it is possible to activate one of the three visualisation/programming modes:



### Info mode

Visualises the general system information.

The list of the parameters that can be visualised is given in the table below.

To access this level, press the key “i/reset” for 1 - 3 s. Release the key immediately when the display shows “Info”.

List of the parameters that can be visualised (in the sequence in which they are visualised)

Parameter number	Parameter
102	Identification date
103	Identification number
113	Burner identification
164	Number of resettable start-ups
166	Total number of start-ups
170.00	Switching cycles relay contact K12
170.01	Switching cycles relay contact K11
170.02	Switching cycles relay contact K2
170.03	Switching cycles relay contact K1
171	Max. relay commutation cycles
End	

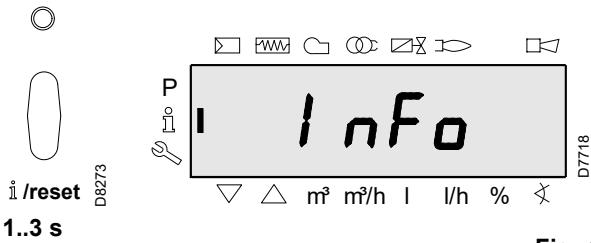


Fig. 42

## 6.4 Info level

The Info level displays information regarding the unit and general operations.

**Note:**

From the Info level, it is possible to press or to display the preceding or subsequent parameter.

Instead of the key it is also possible to press “i/reset” for <1 second.

**Note:**

It is possible to press or “i/reset” for > 8 seconds to return to normal display.

### 6.4.1 Displaying the Info level

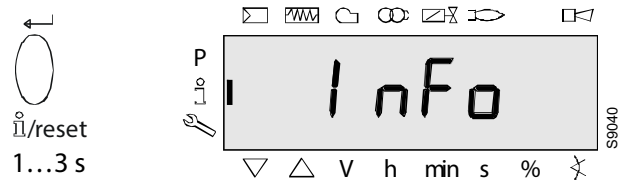


Fig. 44

Press “i/reset” until InFo is displayed.

Releasing “i/reset” takes you to the Info level.

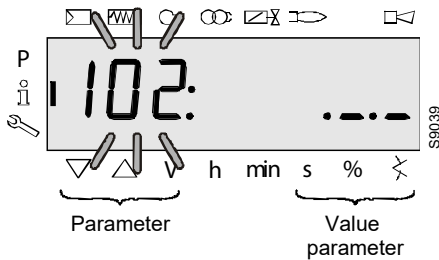


Fig. 43

**Note:**

No change to the Info level value.

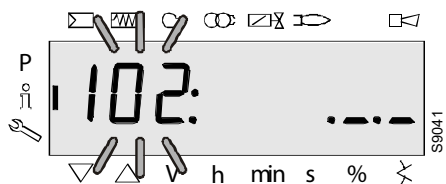
If the display shows. \_\_ together with the parameter, the value can be composed of more than 5 figures.

When pressing “i/reset” for > 1 second and < 3 seconds, the value will be displayed.

By pressing “i/reset” for > 3 seconds or , you go back to the selection of the parameter no. (the number of the parameter blinks).

**6.5 Displaying the Info values**

**6.5.1 Identification date**

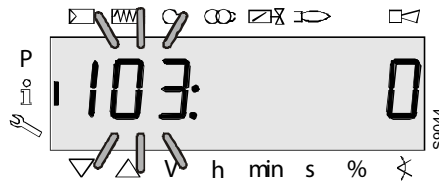


**Fig. 45**

On the left, the parameter **102** is displayed: blinking.  
On the right, **..\_** is displayed.

Example: **102: ..\_**

**6.5.2 Identification number**




**Fig. 49**

On the left, the parameter **103** is displayed: blinking.  
On the right, the identification number **0** is displayed.

Example: **103: 0**

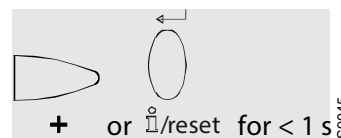


**Fig. 46**

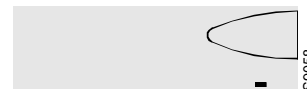
Press  "i/reset" for 1-3 seconds to display the date identification **DD.MM.YY**.

Example: Identification date **03.11.05**

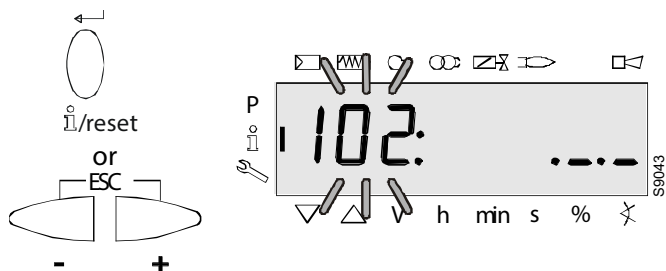
On to next parameter





Goes back to the previous parameter



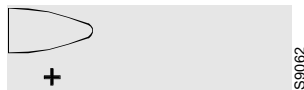
**Fig. 50**



**Fig. 47**

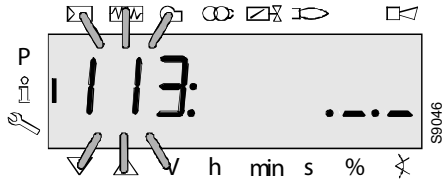
Press  "i/reset" or  to return to the display of the parameters.

On to next parameter



**Fig. 48**

**6.5.3 Burner identification**



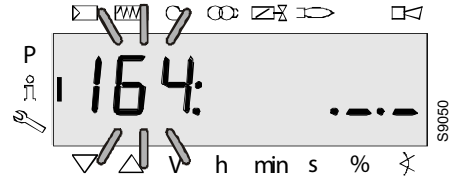
**Fig. 51**

On the left, the parameter **113** is displayed: blinking.  
 On the right, **..\_** is displayed  
 Example: **113**: **..\_**

**6.5.4 Number of resettable start-ups**

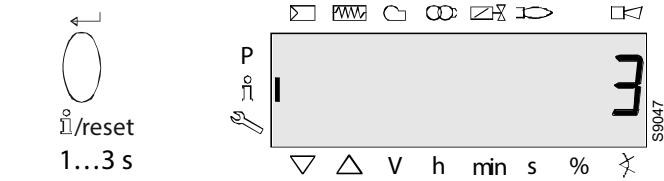
**Note:**

They can be cancelled for assistance (see Parameter list page)!



**Fig. 56**

On the left, the parameter **164** is displayed: blinking.  
 On the right, the characters **..\_** are displayed  
 Example: Parameter **164**: **..\_**

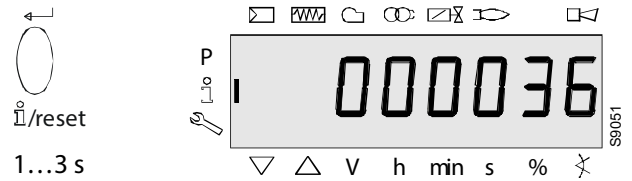


**Fig. 52**

Press "i/reset" for 1-3 seconds to display the burner identification.

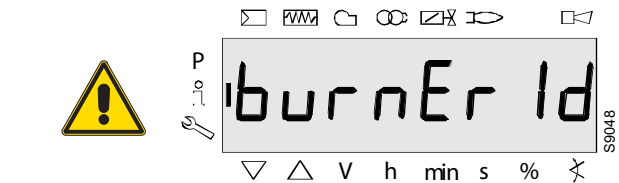
Factory Setting: -----

Example: **3**



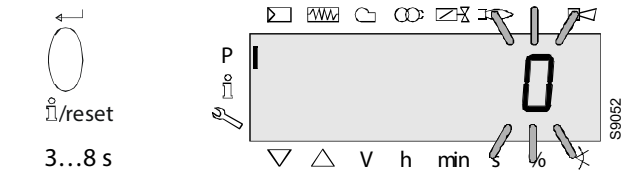
**Fig. 57**

Press "i/reset" for 1-3 seconds to display the number of starts (resettable). Example: **000036**.



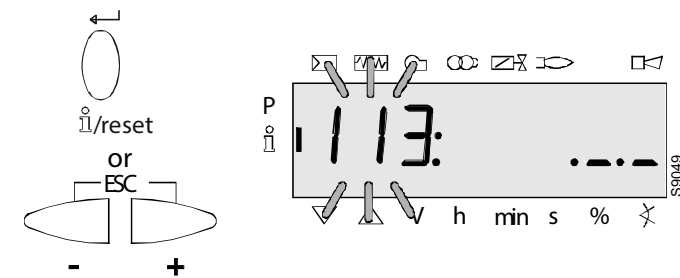
**Fig. 53**

**burnEr Id** can only be changed with the software diagnostic tool ACS410 PC.



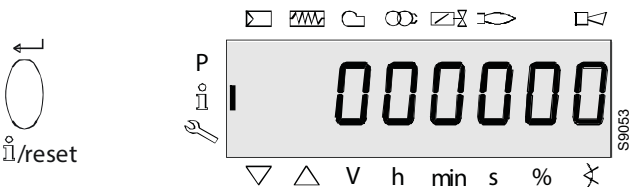
**Fig. 58**

Press "i/reset" for 3-8 seconds to go to the interval, which can be modified. The number **0** blinks.



**Fig. 54**

Press "i/reset" or "ESC" to return to the display of the parameters.



**Fig. 59**

Pressing "i/reset", the number of starts is reset to **0**.

Display: **000000**



On to next parameter



Goes back to the previous parameter

**Fig. 55**



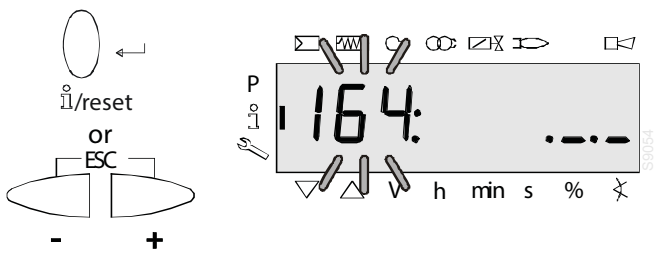


Fig. 60

Press “i/reset” or to display the blinking parameter **164** again.

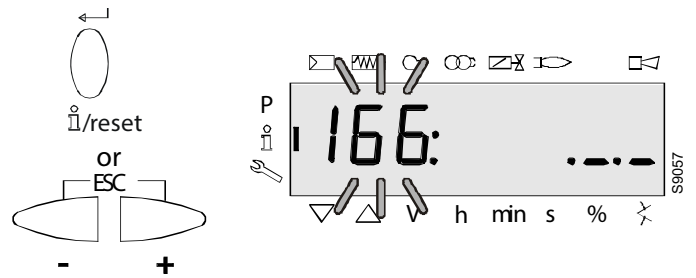


Fig. 64

Press “i/reset” or to return to the display of the parameters.

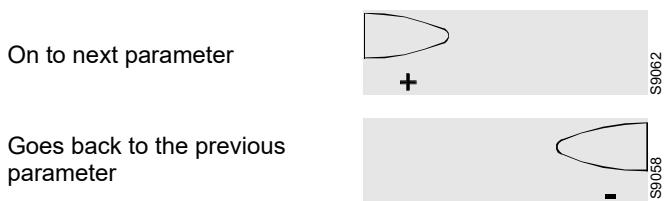


Fig. 61

On to next parameter

Goes back to the previous parameter

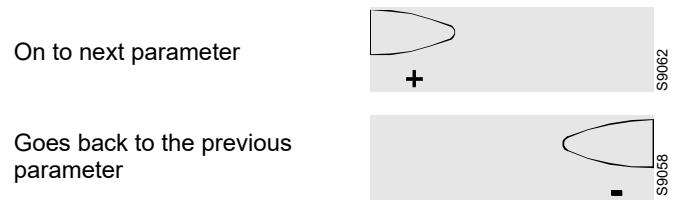


Fig. 65

On to next parameter

Goes back to the previous parameter

### 6.5.5 Total number of start-ups

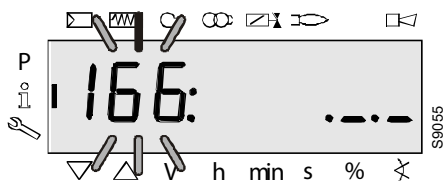


Fig. 62

On the left, the parameter **166** is displayed: blinking.  
On the right, the characters **..** are displayed

Example: Parameter **166**: **..**

### 6.5.6 End of the Info level

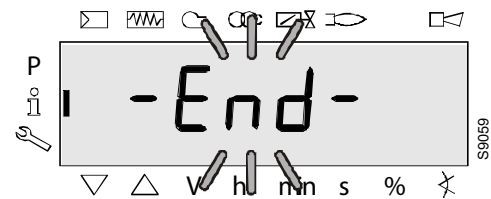


Fig. 66

When this page appears you have reached the end of the Info level.

The display shows **- End -** blinking.

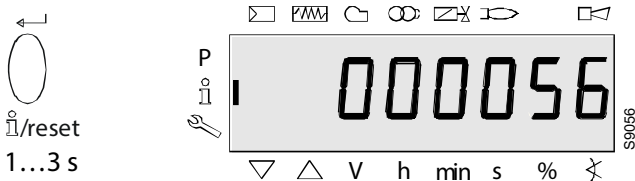


Fig. 63

Press “i/reset” for 1-3 seconds to display the number of starts.

Example: **000056**

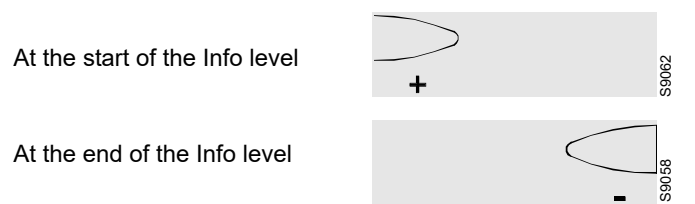


Fig. 67

At the start of the Info level

At the end of the Info level

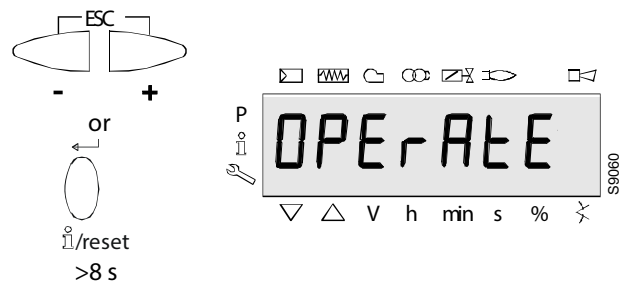
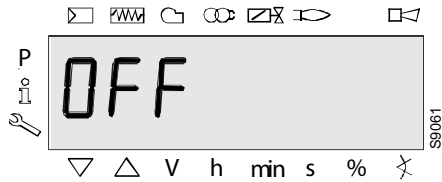


Fig. 68

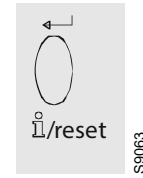
Press or “info” to return to standby mode.

The display shows **OPERATE**.



**Fig. 69**

When this screen appears you return to the normal display and you can pass to the successive level mode.



**Fig. 70**

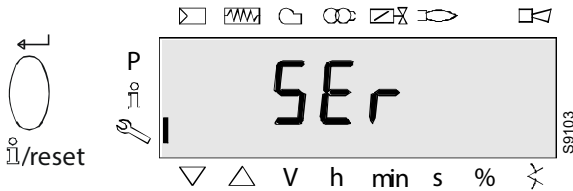
Press "i/reset" to switch between the Service and Parameter level.

**Service mode**

Visualises the log of errors and some technical information regarding the system.

The list of the parameters that can be visualised is given in the table below.

To access this level, press the "i/reset" key for more than 3s. Release the key immediately when the display shows "SEr".



**Fig. 71**

The list of the parameters that can be visualised is given in the table below.

Parameter number	Parameter
<b>700</b>	<b>Error history</b>
<b>701.00</b>	Current error: Error code
<b>701.01</b>	Current error: Start-up meter reading
<b>701.02</b>	Current error: MMI phase
<b>701.03</b>	Current error: Power value
<b>702.00</b>	Error history former 1: Error code
<b>702.01</b>	Error history o1: Start-up meter reading
<b>702.02</b>	Error history o1: MMI phase
<b>702.03</b>	Error history o1: Power value
-	
-	
-	
<b>711.00</b>	Error history former 10: Error code
<b>711.01</b>	Error history former 10: Start-up meter reading
<b>711.02</b>	Error history former 10: MMI phase
<b>711.03</b>	Error history former 10: Power value
<b>900</b>	<b>Process data</b>
<b>920</b>	Current PWM signal fan
<b>936</b>	Normalized speed
<b>951</b>	Mains voltage
<b>954</b>	Flame intensity
<b>End</b>	

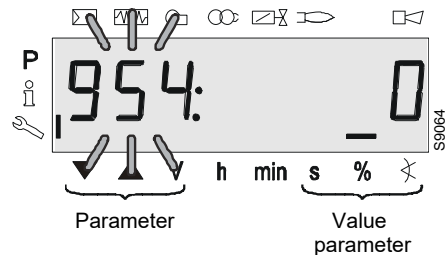
**6.6 Service level**

The Service level is used to display information about the errors including the error chronology.

**Note:**  
From the Service level, it is possible to press or to display the preceding or successive parameter.

**Note:**  
Instead of it is also possible to press "i/reset" for <1 second.

**Note:**  
It is possible to press or "i/reset" for > 8 seconds for normal display.



**Fig. 72**

**Note:**  
No changes to the values of the Service level.  
If the characters re displayed by the parameter, the value can be composed of more than 5 figures.  
Press "i/reset" for >1 s and <3 s to display the value.  
Press "i/reset" for >3 s or to go back to the selection of the parameter number (blinking).

**6.6.1 Displaying the Service values**

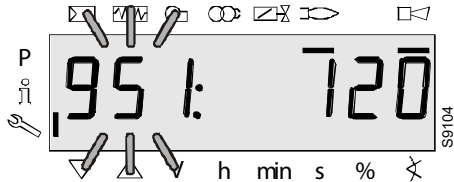
**Error history**

See Parameter with index, with or without direct display/Example of parameter **701**: Error history

**Note:**

They can be cancelled for assistance (see Parameter list page)!

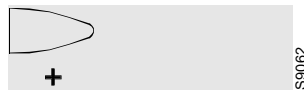
**Mains voltage**



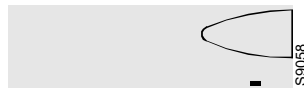
**Fig. 73**

Parameter **951** is displayed: blinking.  
The mains voltage is displayed on the right.  
Example: **951: 120**

On to next parameter

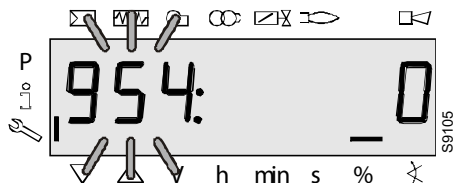


Goes back to the previous parameter



**Fig. 74**

**Flame intensity**

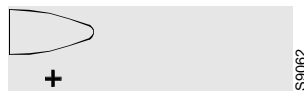


**Fig. 75**

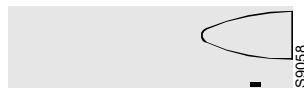
The display shows the parameter **954**: blinking.  
On the right, the flame intensity is displayed in a percentage from 0 to 100%.

Example: **954: 0**

End of the Service level – **End** –

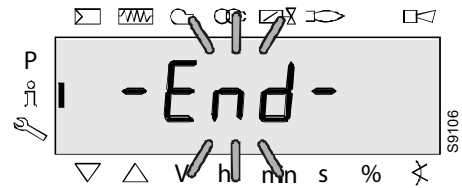


Goes back to the previous parameter



**Fig. 76**

**End of the Service level**

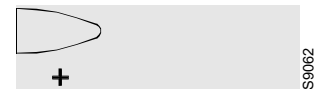


**Fig. 77**

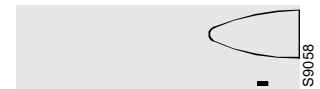
When this page appears you have reached the end of the Service level.

The display shows – **End** – blinking.

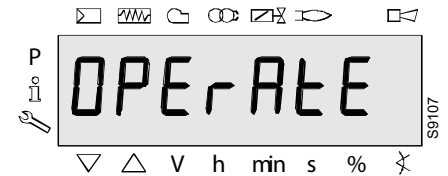
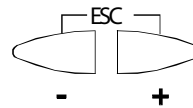
At the start of the Service level




At the end of the Service level



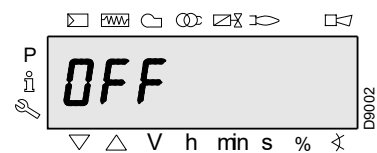
**Fig. 78**



**Fig. 79**

Press  to return to standby mode.

The display shows **OPERATE**.



**Fig. 80**

When this screen appears you return to the normal display and you can pass to the successive level mode.

**Parameter mode (PArA)**

Displays the complete list of parameters and allows you to modify/program it.

The parameters level is subdivided into groups:

<b>000: InF</b>	<b>Internal parameters</b> Carrying out backup/restore procedure.
<b>100: ParA</b>	<b>General parameters</b> Information and identification data of the system.
<b>200: ParA</b>	<b>Checks on the burner</b> Safety intervention times of the various phases (setting parameters and leak detection control times).
<b>400: Set</b>	<b>Setting work points</b> Adjusting the rpm of the fan on start-up (P0), at the minimum (P1) and at the maximum (P2).
<b>500: ParA</b>	<b>Fan parameters</b> Setting the adjustment field of the number of rpm of the fan at start-up (P0), at the minimum (P1) and at the maximum (P2), ascent/descent ramps.
<b>600: ParA</b>	<b>PWM fan parameters</b> Setting the PWM signal/times adjustment field of the fan. Setting the analogue input signal (3 positions, 0...10V, 0...20mA, 4...20mA, 0-135 Ω) used for the modulation.
<b>700: HIST</b>	<b>Log of the errors:</b> Choice of different visualisation modes for the errors log.
<b>900: dAtA</b>	<b>Process information</b> Displaying the value of the PWM signal (%), the control box power supply voltage and the intensity of the flame signal.
<b>End</b>	

To access this level, refer to "Access procedure with password". Once the access procedure has been carried out, the display will show "PArA" for a few seconds.



**Fig. 81**

Select the desired group of parameters with keys "+" and "-", and confirm by pressing the key "i/reset".

Within the group you have chosen, scroll through the list with the keys "+" and "-". At the end of the list, the display shows "End".

To return to Normal visualisation mode, simultaneously press the keys "+" and "-" (esc) twice.

To modify a parameter, refer to "Parameter modification procedure".



All the parameters are checked in the factory. Modification/tampering may compromise the good operation of the burner and cause injury to people or damage to things. In any case, modifications must be carried out by qualified personnel.

**6.7 Parameters level**

The parameters in the unit's memory can be displayed or modified in the Parameters level.

To pass to the parameters level a password is required.

With the LME7..., the control characteristics of the burner are mainly established by the parameter settings. Each time that the unit is started, the settings of the parameters should be controlled.

The LME7... should never be transferred from one system to another without the parameters matching those of the new system.



The parameters and the settings can be modified only by qualified personnel.

See the list of parameters for controlling the parameters that are read-only or that can also be changed (See "List of parameters PME71.901..." on page 68).

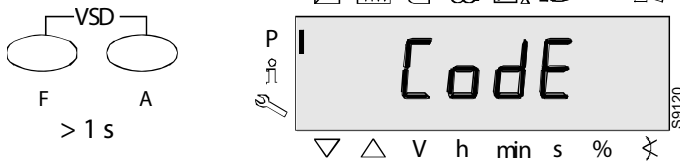
**Key:**

SO = Service operator (password for service);

OEM = Manufacturer (password for manufacturer).

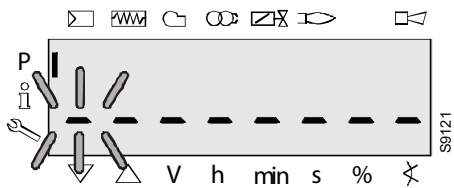
**6.7.1 Entering the password**

The OEM password should be composed of 5 characters, the technical one 4 characters.



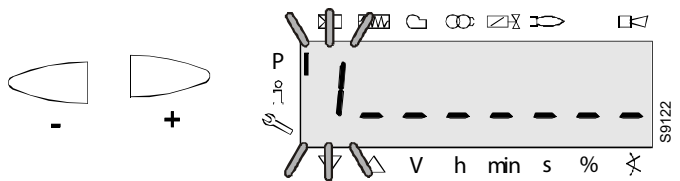
**Fig. 82**

Press the combination of keys to display **CodE**.



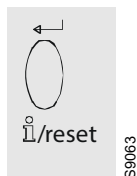
**Fig. 83**

Releasing the keys, 6 bars appear, the first of which is blinking.

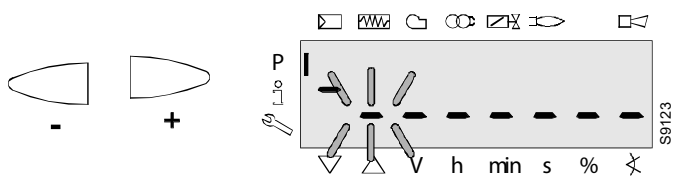


**Fig. 84**

Press or to select a number or a letter.

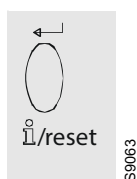


**Fig. 85**

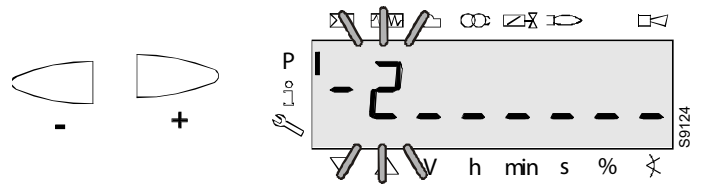


**Fig. 86**

Press to confirm. The value entered is replaced by the minus sign (-). The next bar starts blinking.

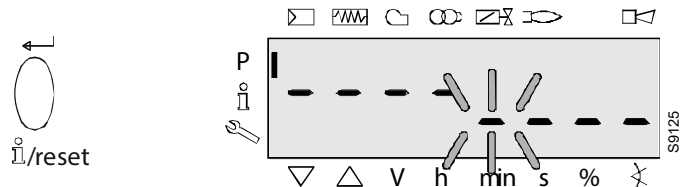


**Fig. 87**



**Fig. 88**

Press or to select a number or a letter.



**Fig. 89**

After entering the last character the password needs to be confirmed by pressing the "i/reset" key.

Press "i/reset" again to finish entering the password.

Example: The password is composed of 4 characters.



**Fig. 90**

To confirm it has been entered correctly, **PArA** is displayed for a maximum of 2 seconds.

**Note:**

To enter the password or the burner ID, the following numbers and letters can be used:

1	= 1	A	= A	L	= L
2	= 2	b	= b	n	= n
3	= 3	C	= C	o	= o
4	= 4	d	= d	P	= P
5	= 5	E	= E	r	= r
6	= 6	F	= F	S	= S
7	= 7	G	= G	t	= t
8	= 8	H	= H	u	= u
9	= 9	I	= I	Y	= Y
0	= 0	J	= J		

S9127

**Fig. 91**

6.7.2 Backup

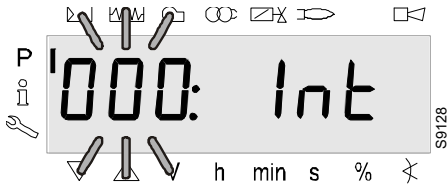


Fig. 92

The parameter **000**:blinks.  
 Display: Parameter **000**: blinks, the display **Int** does not blink.



Fig. 98

Press for the parameter **bAC\_UP**.  
 Display: The parameter **bAC\_UP** blinks.

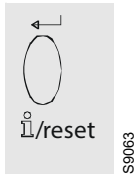


Fig. 93

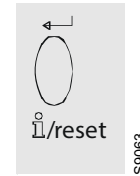


Fig. 99

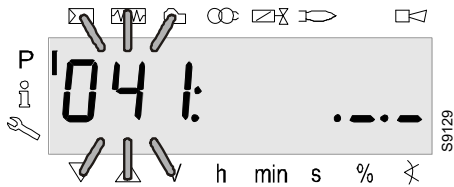


Fig. 94

Press "i/reset" for the group of parameters **041**.  
 Display: Parameter **041**: blinks, the display **...** does not blink.



Fig. 100

Press "i/reset" for the backup process.  
 Display: The value **0**.

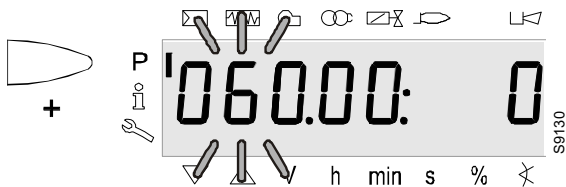


Fig. 95

Press for the parameter **060**.  
 Display: The parameter **060**: blinks, the index **00**: and the value **0** do not blink.

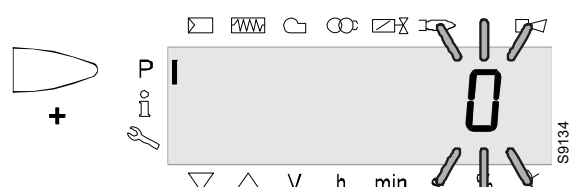


Fig. 101

Press to shift the value by one position to the left.  
 Display: The value **0** blinks.

**Note:**  
 To detect display faults, the value shifts one position to the left.

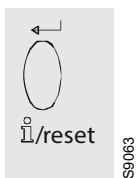


Fig. 96



Fig. 102

Press for the value **1**.  
 Display: The value **1** blinks.



Fig. 97

Press "i/reset" for the parameter **rESTorE**. Display: The parameter **rESTorE** blinks.

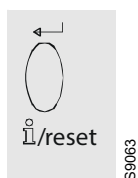


Fig. 103



Fig. 104

Press “i/reset” to start up the backup process.

The display shows **run**.



Fig. 105

After about 3 seconds (depending on the duration of the program sequence), the display shows **bAC End** to indicate the end of the backup process.

Display: **bAC End**.

It will be displayed for 2 minutes, or it can be ended by pressing the key “i/reset”.



Fig. 106

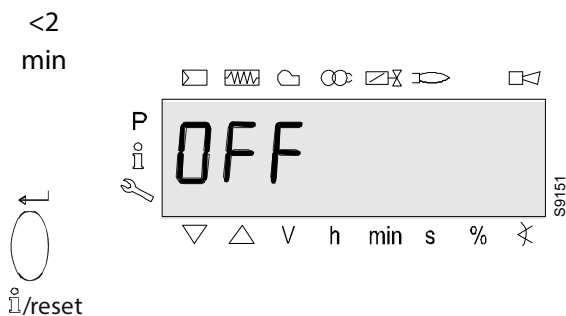


Fig. 107

The displays shows **OFF** when the backup process has finished.



**WARNING**

**Note:**

During the backup, all the parameter settings are transferred from the unit's memory to the memory of the program module (PME).

**If the parameters need to be changed, a backup copy must be made!**

Otherwise there is the risk of losing the safety functions.

**6.7.3 Restore**

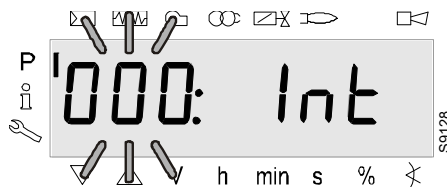


Fig. 108

The parameter **000**: blinks.

Display: Parameter **000**: blinks, the display **Int** does not blink.

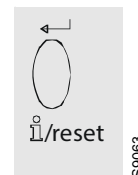


Fig. 109

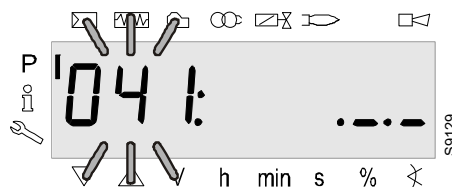


Fig. 110

Press “i/reset” for the group of parameters **041**.

Display: Parameter **041**: blinks, the display **..** does not blink.

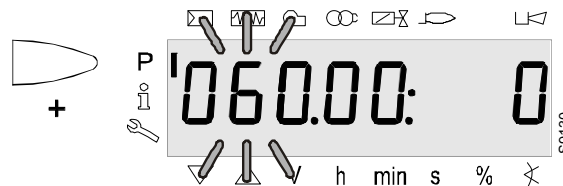


Fig. 111

Press for the parameter **060**.

Display: Parameter **060**: blinks, the index **00**: and the value **0** do not blink.

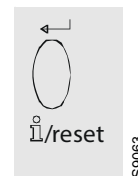


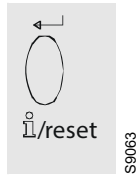
Fig. 112



Fig. 113

Press “i/reset” for the parameter **rESTorE**.

Display: The parameter **rESTorE** blinks.



**Fig. 114**



**Fig. 115**

Press “i/reset” to detect the restore process.  
Display: The value **0**.



**Fig. 116**

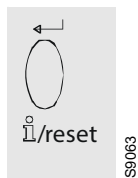
Press to shift the value by one position to the left.  
Display: The value **0** blinks.

**Note:**  
To detect display faults, the value shifts one position to the left.



**Fig. 117**

Press for the value **1**.  
Display: The value **1** blinks.



**Fig. 118**



**Fig. 119**

Press “i/reset” to activate the restore process.  
The display shows **run**.



**Fig. 120**

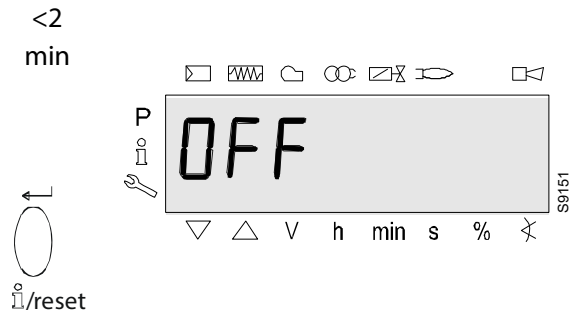
After about 3 seconds (depending on the duration of the program sequence), the display shows **bAC End** to indicate the end of the restore process.

Display: **rSt End**.

It will be displayed for 2 minutes, or it can be ended by pressing “i/reset”.



**Fig. 121**



**Fig. 122**

The displays shows **OFF** when the RESTORE process has finished.



**WARNING**

**Note:**

During the RESTORE process, all the parameters and settings are written from the program module onto the memory integrated into the device. In the meantime it is possible that the previous program sequences, the parameters and the settings in the internal memory could be overwritten! **At the first start-up or after replacing the program module, the sequence of the functions and the parameter settings should be checked when the RESTORE process has finished.** Otherwise there is the risk of losing the safety functions.



**6.8 Parameter modes of operation**

The parameters memorised in the LME7... burner control can be displayed and modified in the Parameters level.

**6.8.1 Parameters without index, with direct display**

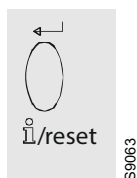
**Example of parameter 225 (pre-purging time) on the Parameters level**



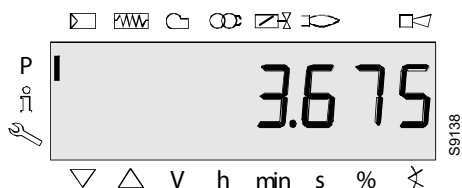
**Fig. 123**

Press for the pre-purging time.

Display: Parameter **225**: blinks, the value **3.675** does not blink.



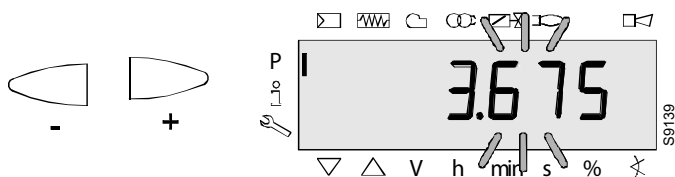
**Fig. 124**



**Fig. 125**

Press “i/reset” for the modification mode.

Display: **3.675**.



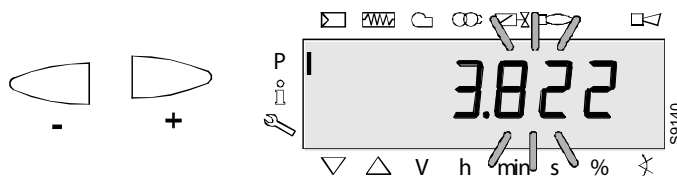
**Fig. 126**

Press or to move the previous pre-purging time by the mode one place to the left.

Display: the pre-purging time **3.675** blinks.

**Note:**

To detect display errors, the value appears shifted by one position to the left.



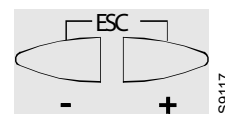
**Fig. 127**

Press or for the required pre-purging time.

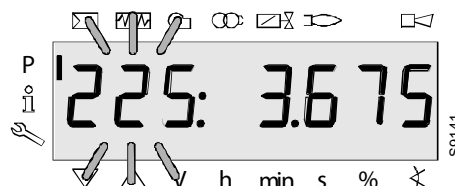
Display: The pre-purging time **3.822** blinks.

**Alternative 1:**

Delete the change!



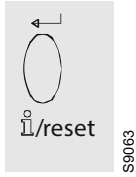
**Fig. 128**



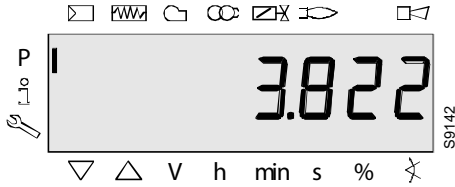
**Fig. 129**

**Alternative 2:**

Adopt the value!



**Fig. 130**



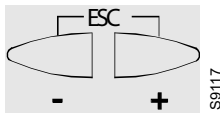
**Fig. 131**

Press **"i/reset"** to go back to the modification mode.  
The set value will be adopted.

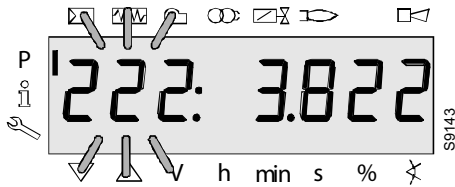
**Note:**

To detect display errors, the value appears shifted by one position to the right.

Display: Value **3.822**



**Fig. 132**

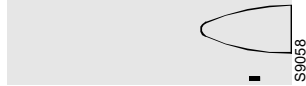


**Fig. 133**

On to next parameter



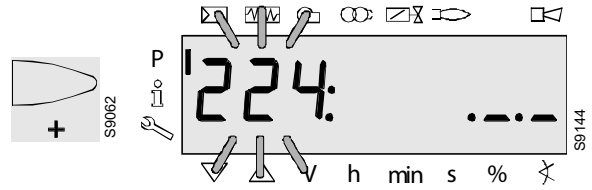
Goes back to the previous parameter



**Fig. 134**

**6.8.2 Parameters without index, without direct display**

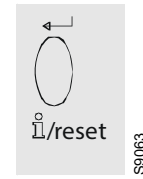
**Example of parameter 224 (air pressure switch specified time) on the Parameters level**



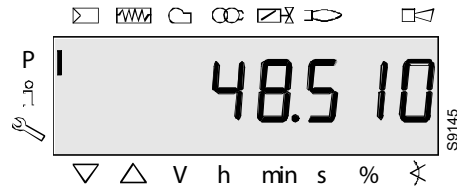
**Fig. 135**

Press **+** for the specified time for the air pressure signal.

Display: Parameter **224**: blinks, characters **.\_.** do not.



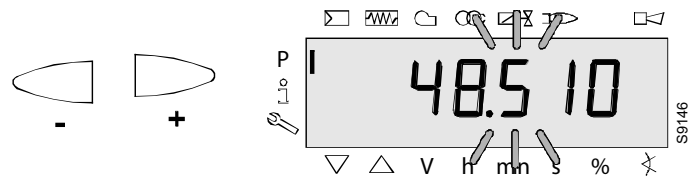
**Fig. 136**



**Fig. 137**

Press **"i/reset"** for the modification mode.

Display: **48.510**.



**Fig. 138**

Press **-** or **+** to change the time previously set by one position to the left.

Display: The specified time **48.510** blinks.

**Note**

To detect display errors, the value appears shifted by one position to the left.

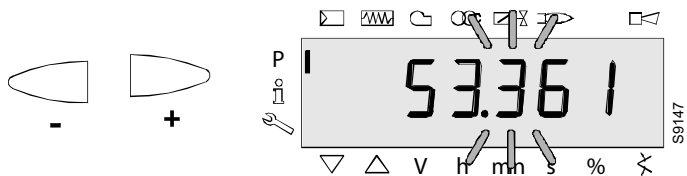


Fig. 139

Press or to set the specified time.

Display: The specified time **53.361** blinks.

**Alternative 1:**

Delete the change!

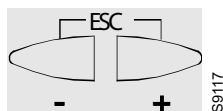


Fig. 140

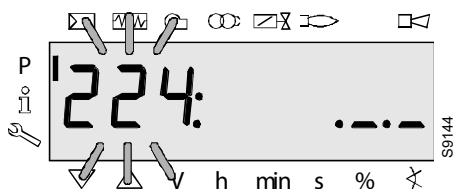


Fig. 141

**Alternative 2:**

Adopt the change!

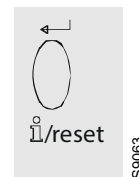


Fig. 142

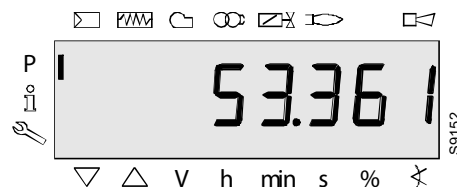


Fig. 143

Press "i/reset" to go back to the modification mode.

The set value will be adopted.

**Note:**

To detect display errors, the value appears again but shifted by one position to the right.

Display: Value **53.361**

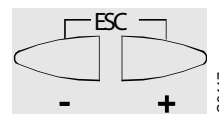


Fig. 144

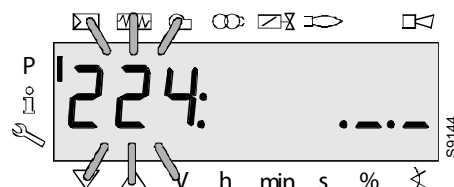
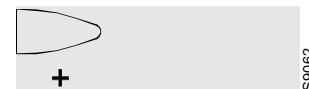


Fig. 145

Press to return to the Parameter level.

Display: Parameter **224**: blinks, characters **.\_.\_** do not.

On to next parameter



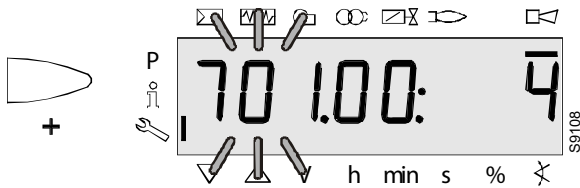
Goes back to the previous parameter



Fig. 146

**6.8.3 Parameters with index, with or without direct display**

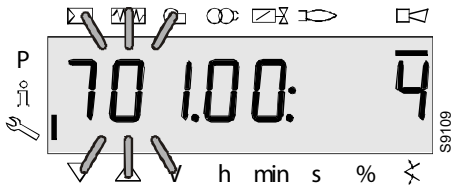
**Example of parameter 701: Actual error at the Service level**  
See chapter *List of error codes!*



**Fig. 147**

Press to select the parameter **701**.

Display: The parameter **701**. blinks, index **00**: and the error **4** does not blink.



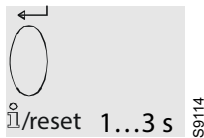
**Fig. 148**

On the left, the error **701**. i displayed blinking, the index **00**: does not blink.

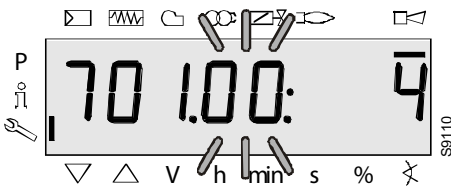
On the right, the error code **4** is displayed.

Example:

Parameter **701**., index **00**., error code **4**.



**Fig. 149**

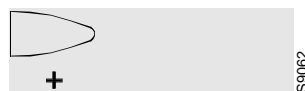


**Fig. 150**

Press for 1-3 seconds to display the index **00**: for the blinking error code.

Display: The parameter **701**. does not blink, the index **00**: blinks, the error **4** does not blink.

At the successive index



**Fig. 151**



**Fig. 152**

Press , to select the index.

**.00** = error code

**.01** = start meter reading

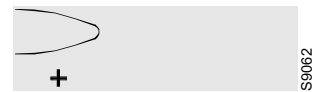
**.02** = MMI phase at time of fault

**.03** = current value at the time of the fault

Example:

Parameter **701**., index **01**., start meter reading **\_..\_**

At the successive index



**Fig. 153**



**Fig. 154**

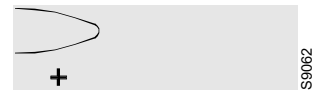
Press , to select the index.

**.02** = MMI phase at time of fault

Example:

Parameter **701**., index **02**., phase **02** = safety switch off.

At the successive index



**Fig. 155**



**Fig. 156**

Press , to select the index.

**.03** = current value at the time of the fault.

Example:


Parameter **701**., index **03**., phase **02** = value of the current **60%**.



**Fig. 157**



Fig. 158

Press  to return to the index.

Display: The parameter **701**. does not blink, the index **03**: blinks, the characters. **\_ \_** do not.

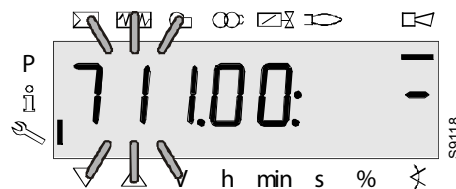


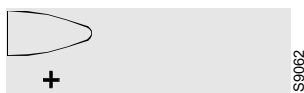
Fig. 164

The parameters cover the period up to the first error recorded starting from the deletion of the history (max. to parameter **711.**).

Example:

Parameter **711.**, index **00**: -

At the successive index



Returns to the previous index

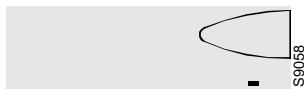
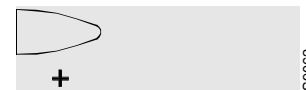


Fig. 159

At the start of the Service level



At the end of the Service level



Fig. 165

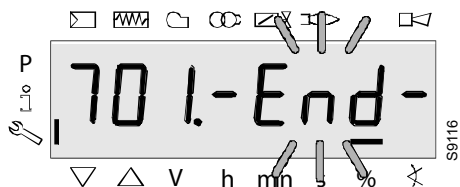


Fig. 160

When this screen appears you have reached the end of the Index level as far as the parameter **701** is concerned.

The display shows **- End -** blinking.

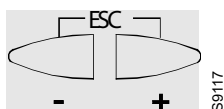


Fig. 161

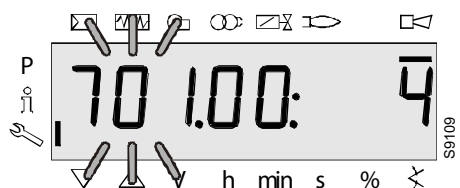



Fig. 162

Press  to return to the Parameter level.

Display: The parameter **701**. blinks, the index **01**: and the diagnostic code **4** do not blink.

To the oldest successive error

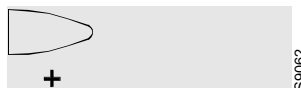


Fig. 163

**7 Start-up, calibration and operation of the burner**

**7.1 Notes on safety for the first start-up**



The first start-up of the burner must be carried out by qualified personnel, as indicated in this manual and in compliance with the standards and regulations of the laws in force.



Check the correct working of the adjustment, command and safety devices.



Refer to paragraph “Safety test - with gas ball valve closed” on page 59 before the first start-up.

**7.2 Adjustments prior to ignition**

The following adjustments must be carried out:

- open the manual valves upline of the gas train;
- bleed the air from the gas pipes using the screw on the socket (Fig. 25 on page 27).
- Adjust the minimum gas pressure switch to the start of the scale.

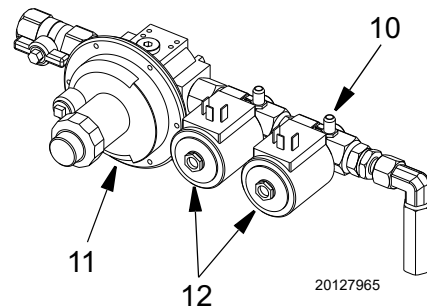
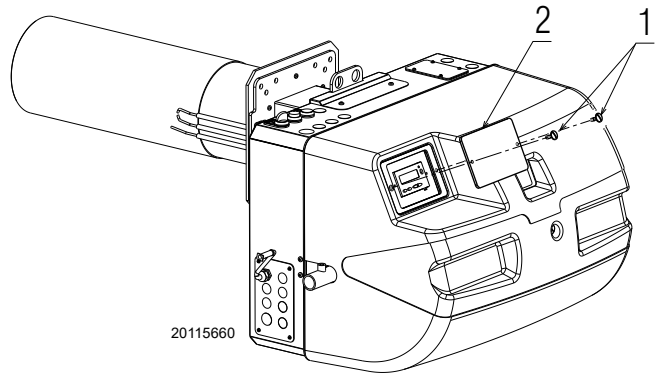
**NOTE:**

**Make sure that the cover has been correctly installed on the burner (the presence or otherwise of the cover considerably affects the depression values measured at the pressure test point downstream of the valve). (See Fig. 25 on page 27)**

To access the display with cover installed, unscrew the screws 1) (Fig. 166) and remove the glass 2).

Key (Fig. 166)

- 1 Screws
- 2 Glass
- 3 Pilot valve encompassing
- 4 Safety valves
- 5 Pilot downstream pressure



**Fig. 166**

**7.3 Fan adjustment**

Modulation is based on variable-speed technology.

The combustion air flow rate can be regulated by varying the motor speed (rpm).

The proportioning gas train delivers the right amount of fuel, depending on the pressure detected in the purging circuit.

So the flow rate supplied is regulated by changing the rotation speed of the motor.

The motor speed can be regulated through an adjustment of the control box.

The adjustments take place on the AZL display on the burner and are carried out using the following parameters:

<b>START</b>	ignition point	(P0) Parameter P 403.00
<b>MIN</b>	minimum point	(P1) Parameter P 403.01
<b>MAX</b>	maximum point	(P2) Parameter P 403.02

**NOTE:**

**The adjustment of the fan (to establish the maximum, minimum and ignition outputs) can occur independently both of**

**the AZL display and the keys and display on board the machine. Below is a description of the procedure to carry out using the AZL display since it allows you to work with the cover installed (final configuration). Points P0, P1 and P2 can be modified within the range defined by the limits set in the parameters 516, 517 and 518 respectively.**

## 7.4 Pre-setting of the points P0 (ignition), P1 (minimum) and P2 (maximum)

The burner leaves the factory with a pre-setting of points P0, P1 and P2.

Before starting the burner we recommend modifying these point based on the maximum output of the boiler, the minimum output desired and that of the ignition.

To set the points based on the desired outputs, see the charts (page 13).

To modify the points P0, P1 and P2 with the burner off, proceed as follows:

- Electric voltage is available (indicator light “POWER ON” must be on).
- Turn the “ON/OFF” selector to “OFF”, standby (OFF).
- Start the programming mode for the technician.
- Keep the buttons “A” and “F” pressed simultaneously for < 5 seconds. “Code” is displayed.
- Entering the password of the technician (SO) using the buttons “+”, “-” and “i/reset”. See also chapter “Entering the password” on page 43.
- The displays shows **PArA** and then **400:Set**. Confirm by pressing “i/reset”;
- The display shows **run**;
- Press simultaneously the keys “+” and “-” (ESC);
- The display shows “**P0: 1200**” (for example 1200 rpm);
- Change the value by pressing simultaneously the keys “A” and “+” to increase the value or keys “A” and “-” to lower the value;
- Confirm by pressing “i/reset”;
- The display shows “**P1: 1200**” (for example 1200 rpm);
- Change the value by pressing simultaneously the keys “A” and “+” to increase the value or keys “A” and “-” to lower the value;
- Confirm by pressing “i/reset”;
- The display shows “**P2: 6100**” (for example 6100 rpm);
- Change the value by pressing simultaneously the keys “A” and “+” to increase the value or keys “A” and “-” to lower the value;
- Confirm by pressing “i/reset”;
- Press contemporaneously the keys “+” and “-” (ESC) several times until the display shows “**OPeArTE**” and then “**OFF**”;

At this point it is possible to start the burner.

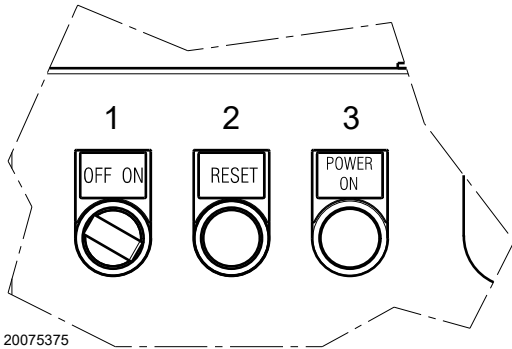
**7.5 Burner start-up**

The burner can operate in two different modes:

- 1 Manual operation (to be used for the initial start-up): in this mode the indicators of the display are blinking;
- 2 Automatic operation (for normal work operation): in this mode the indicators of the display are fixed.

**7.5.1 First burner start-up (manual operation)**

- Electric voltage is available (indicator light "POWER ON" must be on).
- Turn the "ON/OFF" selector to "OFF", standby (OFF).
- Disconnect the external modulation control (control with 3 points or analogue signal).



**Fig. 167**

Key (Fig. 167)

- 1 "OFF/ON" switch
- 2 "RESET" indicator button
- 3 "POWER ON" signal

- Start the programming mode for the technician.
- Keep the buttons "A" and "F" pressed simultaneously for < 5 seconds. "Code" is displayed.
- Entering the password of the technician (SO) using the buttons "+", "-" and "i/reset". See also chapter "Entering the password" on page 43.
- The display passes from **PARa a 400: SEt**. Confirm with the button "i/reset".
- run is displayed. Confirmation with the **i/reset** button starts the setting mode for minimum load (**P1**), ignition load (**P0**) and nominal load (**P2**).
- The display shows **OFF** blinking.
- "Turn the "ON/OFF" selector to "ON" and make sure that there is a heat request (thermostat on ON).
- LME7 starts and carries out a start-up. The corresponding phases of the program are carried out according to the sequence scheme and the program phases are displayed blinking (Tab. M on page 23)
- The device works up to the end of the Ph30 pre-purging phase, it is brought to the starting load and passes to the display of **P0** (number of rpm ignition load). On the left is displayed **P0** blinking, on the right the current rpm.
- keeping button "A" pressed (the display passes to **0A** and the rpm is indicated blinking) and pressing the button "+" or "-", it is possible to modify the rpm number of 10 rpm within the pre-set limits (Parameter P403.00).

**NOTE:**

**The setting for the parameter P0 should be greater than the setting for the parameter P1. The values are checked by the LME7. If the setting rules are violated, the appliance goes into lockout mode, signalling a Loc error:225.**

- Press "i/reset" to transfer the setting value into the internal memory.
- The burner proceeds with the ignition phase. If at the end of the safety time the flame does not appear, the burner restarts in automatic mode (it carries out a maximum of 3 attempts).  
The indications of the sequence of the phases on the display continue to blink to signal that we are still in the start-up procedure (manual operation).  
If ignition is still not achieved, it may be that gas is not reaching the combustion head within the safety time period of 3 seconds.  
Turn the screw V1 of the gas valve lightly towards the "+" sign (Fig. 168 on page 57).  
If, however, at the end of the safety time the burner starts but then switches off, the burner goes into lockout and the display shows **Loc:7** blinking (disappearance of the flame when in operation).  
Press "i/reset", the display shows **400:Set**. Exit the manual operation mode by several times pressing "ESC" (press the keys "+" and "-" contemporaneously).  
The display shows **Loc:7** fixed. Press "i/reset" to unblock the LME7. (List of error codes Tab. X on page 63).

**NOTE:**

**To go back to manual mode it is necessary to turn the "ON/OFF" selector to "OFF" and repeat the first start-up sequence with the technician programming mode. If the selector remains on "ON" the burner restarts in automatic mode (it normally carries out all the ignition phases without stopping, at the end of the pre-purging time, at point P0).**

- Turn the screw V1 towards the "+" sign (Fig. 168 on page 57).
- The burner is switched on, the program continues to the minimum load position **P1**. On the left is displayed P1 blinking, on the right the current rpm.
- keeping button "A" pressed (the display passes to **1A** and the rpm is indicated blinking) and pressing the button "+" or "-", it is possible to modify the rpm number of 10 rpm within the limits pre-set by the OEM (Parameter P403.01).
- Check the appearance of the flame, if possible, or the value of the CO and CO<sub>2</sub> to understand whether the burner has been sufficiently calibrated (first maximum calibration). If necessary use the screw V2 of the gas valve (turn towards the "+" sign to increase the gas, towards the "-" sign to decrease the gas) (Fig. 168 on page 57).



**NOTE:**

after the control box has remained in the same setting phase for some time (example point P1), the display exits from the regulation of the number of revs. To re-enter it is necessary to carry out the procedure with access using the technician's password (SO).

- With the button "i/reset" the setting value is confirmed in the internal memory.
- **oP: P1** is displayed quickly. The fan rpm passes to the value for the nominal load **P2**. On the left is displayed **P2** blinking, on the right the current rpm.
- Keeping button "**A**" pressed (the display passes to **2A** and the rpm is indicated blinking) and pressing the button "+" or "-", it is possible to modify the rpm number of 10 rpm within the limits pre-set by the OEM (Parameter P403.02).
- Check the appearance of the flame, if possible, or the value of the CO and CO<sub>2</sub> to understand whether the burner has been sufficiently calibrated (first maximum calibration). If necessary use the screw V1 of the gas valve (turn towards the "+" sign to increase the gas, towards the "-" sign to decrease the gas) (Fig. 168 on page 57).
- With the button "i/reset" the setting value is confirmed in the internal memory.
- From here the speeds of the low flame **P1** or the high flame **P2** can be changed as described above, or else it is possible to end the setting process and pit the burner in automatic mode by pressing several times "**ESC**" (press "+" or "-" and contemporaneously).
- Reset the external modulation control (control with 3 points or analogue signal). In the automatic operation position the output requisites of the external load regulator are valid.

**NOTE:**

To memorise the settings in the PME... program module it is necessary to carry out a manual backup. See "Backup" on page 44.

**WARNING**

Eventual modifications to the parameters and the settings should be set and saved in the memory on-board the unit.

To save the modified settings of the PME7... program module, the backup should be activated manually. If this is not respected you risk losing the safety functions.

**WARNING**

At the first start-up, or else after replacing the program module, it is necessary to check, immediately after the reset process, the sequence of the functions and the settings of the parameters. If this is not respected you risk losing the safety functions.

**WARNING**

If the parameters have been changed, you need to make a backup! If this is not respected you risk losing the safety functions.

### 7.5.2 Checking the modulating operation (automatic operation)

**WARNING**

Before setting the burner in modulating operation carry out the procedure of "Pre-setting the points P0 (ignition), P1 (minimum) and P2 (maximum)" (Paragraph 7.4 on page 53) and of "First burner start-up" (Paragraph 7.5.1 on page 54).

- Electric voltage is available (indicator light "**POWER ON**" must be on).
- Turn the "**ON/OFF**" selector to "**ON**".
- Make sure that the external modulation control (control with 3 points or analogue signal) is connected and working correctly.

**NOTE:**

When the burner is operating the AZL display shows "oP:" meaning modulating operation. The display after "oP:" indicates the value in percentage of the speed. The speed corresponding to 100% is that of point P2 (maximum speed).

To calculate approximately the number of fan revolutions from the percentage "oP" it is necessary to multiply the speed set at point P2 by the percentage read (for example, with P2=6000rpm and oP=20% the speed of the fan is about 1200rpm).

If the speed set at point P2 is modified (to lower the burner output, for example) also the current value, equal to "oP", is modified (e.g.. P2=5000 rpm and oP=20% the fan speed is about 1000 rpm).

**7.6 Combustion head**

The combustion head comprises a highly heat resistant cylinder whose surface features numerous holes, encased in a metal "mesh".

The air-gas mixture is pushed inside the cylinder and out of the head through the holes in the perimeter.

Pilot system operates correctly with pressure between 5 and 20 mbar. Such value can be varied by means of pressure regulator 3)(Fig. 166 on page 52).

Combustion begins with ignition of the air/gas mixture that comes out of the pilot system by means of the electrode spark.

After the stabilization of the pilot flame (approx. 3 seconds), the main valve opens up and, after approx. 7 seconds, the pilot flame goes out while the main one stays on.

The metal "mesh" is the combustion head's most essential element since it improves burner performance considerably.

The flame developed on the surface of the head is perfectly retained and adheres to the mesh when operating at the maximum setting.

This allows modulating ratios as high as 6:1, avoiding the danger of flashback when modulating is at its minimum.

The flame features an extremely compact geometry, meaning that there is no risk of contact between the flame and parts of the generator, consequently eliminating the possible problem of poor combustion.

The flame's structure means that smaller combustion chambers can be developed, designed to exploit this particular feature.



Before starting up the burner, it is good practice to adjust the gas train so that ignition takes place in conditions of maximum safety, i.e. with gas delivery at the minimum.

## 7.7 Burner adjustment

The optimum adjustment of the burner requires an analysis of flue gases at the generator outlet.

The burner application at the generator, the adjustment and the testing must be carried out in compliance with the instruction manual of the generator itself, including the control of the concentration of CO and CO<sub>2</sub> in the flue gases and of their temperature.

Check in sequence:

- MAX output
- MIN output

The **MAX output** should be equal to the value requested by the boiler used. To increase or decrease its value use the external modulation control.

Measure the gas delivery on the counter to precisely establish the burnt output.

Using a smoke analyser, measure the value of the CO<sub>2</sub> or the O<sub>2</sub> in order to optimise the burner calibration.

The correct values are: CO<sub>2</sub> 8.2 - 9% (for methane).

To correct these values act on the gas valve in the following way:

- to increase the gas delivery and the CO<sub>2</sub>: turn the V1 screw towards the "+" sign (Fig. 168);
- to reduce the gas delivery and the CO<sub>2</sub>: turn the V1 screw towards the "-" sign (Fig. 168);.

The **MIN output** should be equal to the value requested by the boiler used. To increase or decrease its value use the external modulation control.

Measure the gas delivery on the counter to precisely establish the burnt output (to be adjusted depending on gas pressure).

Using a smoke analyser, measure the value of the CO<sub>2</sub> or the O<sub>2</sub> in order to optimise the burner calibration.

The correct values are: CO<sub>2</sub> 7.8 - 8.5% (for methane).

To correct these values act on the gas valve in the following way:

- to increase the gas delivery and the CO<sub>2</sub>: turn the V2 screw towards the "+" sign;
- to reduce the gas delivery and the CO<sub>2</sub>: turn the V2 screw towards the "-" sign;.

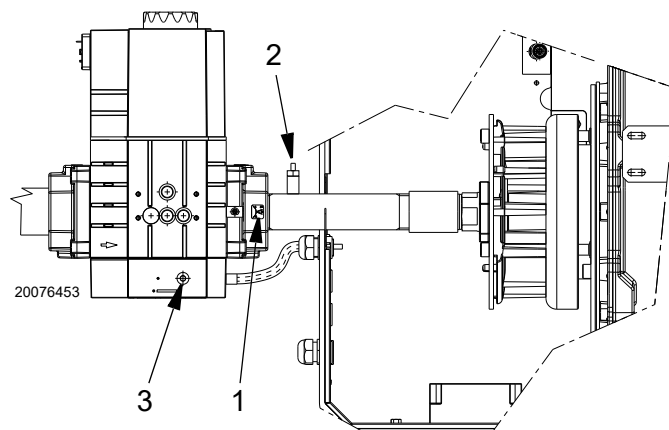


Fig. 168

Key (Fig. 168)

- 1 Maximum gas flow adjustment (V1)
- 2 Pressure point downstream
- 3 Minimum gas flow adjustment (V2)

### 7.7.1 Indicative calibration values

	MIN output		MAX output	
	CO <sub>2</sub> (%)	O <sub>2</sub> (%)	CO <sub>2</sub> (%)	O <sub>2</sub> (%)
Methane	8	6.6	8.5	5.7
LPG	9.5	6.4	10	5.6
G25	7.8	6.8	8.3	5.8

Tab. R

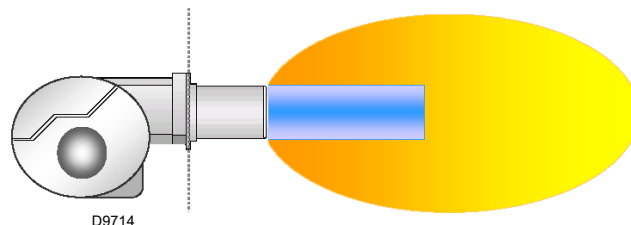


Fig. 169

## 7.8 Switching off the burner

Turn the "ON/OFF" switch to "OFF" (Fig. 167 on page 54).

Disable the electrical supply. If the burner is off for long periods, close the manual gas gates.



WARNING

Turning the "ON/OFF" switch to "OFF" position during the burner post-ventilation phase, the equipment shuts down after a few seconds (ERROR LOC:83).

## 7.9 Load controller inputs

### Selecting the default output analogue source/phases input with 3 positions (P654)





The following input signals can be selected and managed using the parameter P654.

- 3 positions phase input (ASZxx.3x feedback potentiometer necessary/depending on the sequence of the program)
- 0...10 V
- 0...135 Ω
- 0...20mA
- 4...20 mA with lockout at I <4 mA (AZL2...: Loc: 60)

NOTE:

For the connections, see the wiring diagrams.

### 7.10 Final checks (with burner operating)

<ul style="list-style-type: none"> <li>➤ Open the thermostat/pressure switch TL</li> <li>➤ Open the thermostat/pressure switch TS</li> </ul>		The burner must stop
<ul style="list-style-type: none"> <li>➤ Turn the gas maximum pressure switch knob to the minimum end of scale position (where present)</li> </ul>		The burner must stop in lockout
<ul style="list-style-type: none"> <li>➤ Turn off the burner and cut off the power</li> <li>➤ Disconnect the minimum gas pressure switch connector</li> </ul>		The burner must not start
<ul style="list-style-type: none"> <li>➤ Disconnect the wire of the ionisation probe</li> </ul>		The burner performs the ignition cycle again

**Tab. S**



**WARNING**

Make sure that the mechanical locking systems on the various adjustment devices are fully tightened.

## 8

## Maintenance

## 8.1 Notes on safety for the maintenance

The periodic maintenance is essential for the good operation, safety, yield and duration of the burner.

It allows you to reduce consumption and polluting emissions and to keep the product in a reliable state over time.



DANGER

The maintenance interventions and the calibration of the burner must only be carried out by qualified, authorised personnel, in accordance with the contents of this manual and in compliance with the standards and regulations of current laws.

Before carrying out any maintenance, cleaning or checking operations:



DANGER

Turn off the burner's power supply using the main system switch.



DANGER

Turn off the fuel interception tap.



Wait for the components in contact with heat sources to cool down completely.

## 8.2 Maintenance programme

## 8.2.1 Maintenance frequency



The gas combustion system should be checked at least once a year by a representative of the manufacturer or another specialised technician.

## 8.2.2 Safety test - with gas ball valve closed

It is fundamental to ensure the correct execution of the electrical connections between the gas solenoid valves and the burner to perform safely the commissioning.

For this purpose, after checking that the connections have been carried out in accordance with the burner's electrical diagrams, an ignition cycle with closed gas ball valve -dry test- must be performed.

- 1 The manual ball gas valve must be closed
- 2 The electrical contacts of the burner limit switch need to be closed
- 3 Ensures closed the contact of the low gas pressure switch
- 4 Make a trial for burner ignition

The start-up cycle must be as follows:

- Starting the fan for pre-ventilation
- Performing the gas valve seal control, if provided
- Completion of pre-ventilation
- Arrival of the ignition point
- Power supply of the ignition transformer
- Electrical Supply of solenoid gas valves

Since the manual gas ball valve is closed, the burner will not light up and its control box will go to a safety lockout condition.

The actual electrical supply of the solenoid gas valves can be verified by inserting a tester. Some valves are equipped with light signals (or close/open position indicator) that turn on at the same time as their power supply.



WARNING

**IF THE ELECTRICAL SUPPLY OF THE GAS VALVES OCCURS AT UNEXPECTED TIMES, DO NOT OPEN MANUAL GAS BALL VALVE, SWITCH OFF POWER LINE; CHECK THE WIRES; CORRECT THE ERRORS AND REPEAT THE COMPLETE TEST.**

## 8.2.3 Checking and cleaning



The operator must use the required equipment during maintenance.

**Combustion**

The optimum calibration of the burner requires an analysis of the flue gases.

Significant differences with respect to the previous measurements indicate the points where most care should be exercised during maintenance.

**Combustion head**

Open the burner and make sure that all components of the combustion head are in good condition, not deformed by the high temperatures, free of impurities from the surroundings and correctly positioned.

**Burner**

Check that there are not excess wear or loosen screws.  
Clean the outside of the burner.  
Clean and grease the adjustable profile of the cams.

**Fan**

Check to make sure that no dust has accumulated inside the fan or on its blades, as this condition will cause a reduction in the air flow rate and provoke polluting combustion.

### Boiler

Clean the boiler as indicated in its accompanying instructions in order to maintain all the original combustion characteristics intact, especially the flue gas temperature and combustion chamber pressure.

### Gas leaks

Make sure that there are no gas leaks on the pipe between the gas meter and the burner.

### Gas filter

Change the gas filter when it is dirty.

### Measuring circuit for measuring the current detector

The minimum current necessary for the control box operation is 1  $\mu\text{A}$ . The burner normally supplies a higher current value, so that no check is needed.

Anyway, if you want to measure the ionisation current, you need to open the connector (CN1) fitted on the red wire and insert a microammeter.

### Flame control

Displayed value:

MIN 1  $\mu\text{A}$  = 20%

MAX 40  $\mu\text{A}$  = 100%



This display is possible only in operating mode or in stand-by!

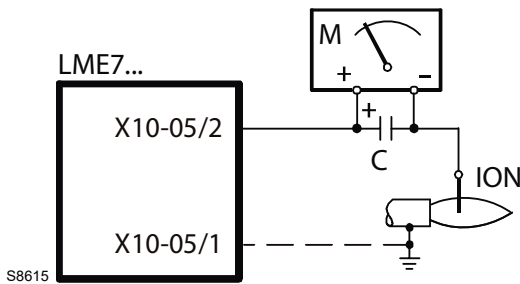


Fig. 170

Key (Fig. 170)

C Electrolytic capacitor 100...470  $\mu\text{F}$ ; DC 10...25 V

ION Ionisation probe

M Microammeter Ri max. 5,000  $\Omega$

### Combustion

In case the combustion values found at the beginning of the intervention do not respect the standards in force or, in any case, do not correspond to a proper combustion, contact the Technical Assistance Service in order to carry out the necessary adjustments.

	MIN output		MAX output	
	CO <sub>2</sub> (%)	O <sub>2</sub> (%)	CO <sub>2</sub> (%)	O <sub>2</sub> (%)
Methane	8	6.6	8.5	5.7
LPG	9.5	6.4	10	5.6
G25	7.8	6.8	8.3	5.8

Tab. T

### 8.2.4 Safety components

The safety components must be replaced at the end of their life cycle indicated in Tab. U. The specified life cycles do not refer to the warranty terms indicated in the delivery or payment conditions.

Safety component	Life cycle
Flame control	10 years or 250,000 operation cycles
Flame sensor	10 years or 250,000 operation cycles
Gas valves (solenoid)	10 years or 250,000 operation cycles
Pressure switches	10 years or 250,000 operation cycles
Pressure adjuster	15 years
Servomotor (electronic cam) (if present)	10 years or 250,000 operation cycles
Oil valve (solenoid) (if present)	10 years or 250,000 operation cycles
Oil regulator (if present)	10 years or 250,000 operation cycles
Oil pipes/ couplings (metallic) (if present)	10 years
Flexible hoses (if present)	5 years or 30,000 pressurised cycles
Fan impeller	10 years or 500,000 start-ups

Tab. U

## 8.3 Opening and closing the burner



Turn off the burner's power supply using the main system switch.



Wait for the components in contact with heat sources to cool down completely.



Turn off the fuel interception tap.



After carrying out maintenance, cleaning or checking operations, reassemble the cover and all the safety and protection devices of the burner.

#### 8.4 Recommended preventive maintenance programme

The use and maintenance instructions are meant for general applications. For specific use and maintenance instructions, contact the manufacturer of the control box.

Test/Inspection	Frequency
Checking components, monitor and indicators	DAILY
Checking adjustments of instruments and control boxes	DAILY
Checking burner flame	DAILY
Checking ignition device	WEEKLY
Checking flame signal strength	WEEKLY
Checking flame fault control system	WEEKLY
Checking firing rate command	WEEKLY
Visual and acoustic control of the pilot and fuel valves	WEEKLY
Checking fuel, venting, flue or inlet gates	MONTHLY
Test for low updraught, fan air pressure and damper position lockout	MONTHLY
Check low flame start lockout	MONTHLY
High and low gas pressure lockout test	MONTHLY
Recalibration of all the adjustment components	SIX-MONTHLY
Check of system components for detecting flame fault	SIX-MONTHLY
Check of firing rate command	SIX-MONTHLY
Check of piping and cabling of all the lockouts and shutoff valves	SIX-MONTHLY
Inspection of burner components	SIX-MONTHLY
Flame fault detection system, test for hot refractory content	YEARLY
Replacing flame rod according to the manufacturer's instruction	YEARLY
Carrying out a combustion test	YEARLY
Check of coils and diaphragms; testing other operating parts of the control valves and safety shutoff valves	YEARLY
test of the interlocking switch of the fuel valve according to the manufacturer's instructions	YEARLY
Tests for leaks on pilot valves and gas valves	YEARLY
Testing air discharge switch according to the manufacturer's instructions	YEARLY
Testing low flame starting lockout according to the manufacturer's instructions	YEARLY
For gas burners, check the sediment well and the gas filters	AS REQUIRED
Flame fault detection system, test for hot refractory content	AS REQUIRED

Tab. V

### 9.1 Control sequence in the event of a fault

In the event of a lockout, the outlets for fuel valves, burner motor and ignition devices should be immediately deactivated (<1 second).

Causes	Answer
Mains voltage interruption	Restart
Voltage below the undervoltage threshold	Safety switch off
Voltage above the undervoltage threshold	Restart
Extraneous light before the safety time	Lockout
Extraneous light during the standby time	Starting pre-purging, lockout after about 30 seconds maximum
No flame at the end of the safety time	3 recirculation attempts, then shut-down
Flame loss during the operation	Factory settings: lockout Can be configured: (depending on the program module 1 x repetition)
Min pressure switch: fault during operation	Switching of and on the pre-purging

**Tab. W**

In the event of a lockout, the LME71... remains in lockout and the red fault indicator lamp comes on. The burner control can be immediately released. This state is maintained also when the mains supply is interrupted.



**9.2 List of error codes with operation using AZL21... Display**

<b>Error code</b>	<b>Clear text</b>	<b>Possible cause</b>
bAC Er3	Programme module compatibility fault with the base unit during the back-up process	The program sequence of the program module is not compatible with the base unit
Err PrC	Fault with the program module	<ul style="list-style-type: none"> <li>– Error in the data contained in the program module</li> <li>– No program module</li> </ul>
Loc 2	No flame at the end of the safety time	<ul style="list-style-type: none"> <li>– Fuel valves dirty or defective</li> <li>– Flame detector dirty or defective</li> <li>– Burner not adjusted correctly, no fuel</li> <li>– Ignition device defective</li> </ul>
Loc 3	Error with air pressure switch (air pressure switch soldered in position with no load), reduction to specified time (air pressure switch) response time)	<ul style="list-style-type: none"> <li>– Air pressure switch faulty</li> <li>– Loss of air pressure signal after the specified time</li> <li>– The air pressure switch is soldered in a position without load</li> </ul>
Loc 4	Extraneous light	Burner start-up extraneous light
Loc 5	Air pressure error, air pressure switch soldered in an operational position	<ul style="list-style-type: none"> <li>– Air pressure switch time out</li> <li>– The air pressure switch is soldered in an operational position</li> </ul>
Loc 6	Fault with the actuator	<ul style="list-style-type: none"> <li>– Actuator defective or blocked</li> <li>– Faulty connection</li> <li>– Incorrect adjustment</li> </ul>
Loc 7	Loss of flame	<ul style="list-style-type: none"> <li>– Too many flame losses during operation (limitation of repetitions)</li> <li>– Fuel valves dirty or defective</li> <li>– Flame detector dirty or defective</li> <li>– Burner adjustment incorrect</li> </ul>
Loc 8	---	Free
Loc 9	---	Free
Loc 10	Non attributable error (application), internal error	Wiring error or internal error, outlet contacts, other faults
Loc 12	Valve test	Fuel valve 1, leak
Loc 13	Valve test	Fuel valve 2, leak
Loc 14	POC error	POC error valve closure control
Loc 20	Min gas pressure switch open	No gas
Loc 22	Safety loop open	<ul style="list-style-type: none"> <li>– Max gas pressure switch open</li> <li>– Limit thermostat safety lockout</li> </ul>
Loc 60	Analogue power supply source 4...20 mA, I < 4 mA	Wire broken
Loc: 83	PWM fan faulty	<ul style="list-style-type: none"> <li>– The PWM fan does not reach the expected speed within the pre-set period of time, or</li> <li>– After reaching the expected speed, the PWM fan once again falls outside the tolerance range (P650) for a period of time greater than the time admissible for speed deviation (P660)</li> </ul>
Loc 138	Reset process successful	Reset process successful
Loc 139	No program module detected	No program module identified
Loc 167	Manual lockout	Manual lockout
Loc: 206	AZL2... incompatible	Use the latest version
Loc: 225	PWM fan faulty	<ul style="list-style-type: none"> <li>– The fan speed dropped below the PWM pre-purging maximum (P675.00) after reaching the pre-purging speed, or</li> <li>– After reaching the ignition load speed, the PWM maximum ignition load (P675.01) was exceeded</li> </ul>
Loc: 226	PWM fan faulty	Configuration error: <ul style="list-style-type: none"> <li>– Low flame speed &gt; high flame speed, or</li> <li>– Low flame = 0 rpm, or</li> <li>– Maximum speed = 0 rpm</li> </ul>
Loc: 227	PWM fan faulty	One or more parameters violate the minimum/maximum limit
rSt Er1	Programme module compatibility fault with the base unit during the reset process	The sequence of the program module is not compatible with the base unit
rSt Er2	Programme module compatibility fault with the base unit during the reset process	The hardware of the base unit is not compatible with the program module
rSt Er3	Error during the reset process	<ul style="list-style-type: none"> <li>– Fault with the program module</li> <li>– Program module removed during the reset process</li> </ul>

**Tab. X**

**9.3 Resetting of burner control**

When a lockout occurs, the burner control can be immediately released by pressing the “RESET” button (See Fig. 167 on page 54).

**NOTE:**

For the meaning of the diagnostic codes and errors, see the chapter “List of error codes with operation using AZL21... Display” on page 63.

Press the reset button again (info button) for at least 3 seconds to activate the diagnostics interface.

If the diagnostic interface is started accidentally, a condition signalled by the blinking red indicator light, it can be deactivated by pressing the reset button again (info button) for > 3 seconds.

The switching moment is indicated by a pulse of yellow light.

**9.3.1 Diagnostics of the cause of the fault**

After the lockout, the faults indicator lamp stays on fixed. Under these conditions, it is possible to activate the visual diagnostic of the cause of the fault based on the table of colour codes by keeping the reset button pressed for more than 3 seconds (info button).

**Error code table**

**Red blink code fault indicator light - Possible cause**

2 blinks	No flame at the end of the safety time – Fuel valves dirty or defective – Flame detector dirty or defective – Burner not adjusted correctly, no fuel – Ignition device defective
4 blinks	– Extraneous light at burner start-up
7 blinks	Too many flame losses during operation (limitation of repetitions) – Fuel valves dirty or defective – Flame detector dirty or defective – Burner adjustment incorrect
8 blinks	Free
9 blinks	Free
10 blinks	Wiring error or internal error, outlet contacts, other faults
12 blinks	Valve test – Fuel valve 1 leak
13 blinks	Valve test – Fuel valve 2 leak
14 blinks	POC error valve closure control
15 blinks	Error code $\geq 15$ (e.g. according to the type of program module) error code 20: Min gas pressure switch fault error code 22: Safety loop error

**Tab. Y**

During the diagnosis of the cause of the fault, the outputs of the controls are disabled

- The burner stays off
- Indication of external fault (alarm) on the clamp X2-03, foot 3 on fixed

At the outlet of the diagnostic of the cause of the fault the burner is switched on again by resetting the burner control.

Press the reset button (info button) for about 1 second (< 3 seconds).

**9.3.2 Before starting with a new program module or when the program module is replaced**



Alternatively



- The display shows **rSt** and **PrC** alternately.
- The display shows the replacement of the program module.
- The indicator light blinks alternately one red and two yellow.



Press for >3 to start the download of the program module data.  
The indicator light blinks yellow.

- The process that lasts 3 seconds is accompanied by short yellow blinking.

Note: for <3 seconds, the download does not start. To restart the reset process, you need to reset the LME7... switching the mains ON/OFF.



The display shows 'run' during the download (reset process) of the program sequence.



Alternatively



- The display shows **rSt** and **End** alternately.
- The display shows the end of the data exchange.

After 2 minutes, the unit passes to **Loc 138**



Alternatively



- At the end of the reset process, the unit is automatically in a lockout position (LOC 138) and need to be released in order to work!



Press for >1 second to release the unit.  
Display: **OFF**






**Tab. Z**










**WARNING**


**At the first start-up or after replacing the program module, after the completion of the restore process the sequence of the functions and the parameter settings should be checked.**

### 9.4 Manual reset

 and  > 1s
 
 Press contemporaneously  and  for >1 second (Escape) to start the manual reset process. The parameter **PrC** appears.  
 Display: **PrC**

 or 

 Press  and  for the parameter **rSt**.  
 Display: **rSt**


 1..3 s



**run** appears during the download (restore process) of the program sequence.



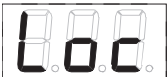
Alternatively



**At the end of the reset process, the unit is automatically in a lockout position (LOC 138) and need to be released in order to work!**

After 2 minutes, the unit passes to **Loc 138**






Alternatively



**At the end of the reset process, the unit is automatically in a lockout position (LOC 138) and need to be released in order to work!**

 > 1s
 

Press  for >1 second to release the unit.  
 Display: **OFF**

Tab. AA

**9.4.1 Error during the reset process**



Alternatively  
with



or



or



The display shows **rSt** and **Er1**, **Er2** or **Er3**.

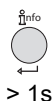
For the meaning of the possible cause, see the chapter "List of error codes with operation using AZL21... Display" on page 63

**Tab. AB**

**NOTE:**

During the restore process, all the parameters and settings are written from the program module onto the memory integrated into the device. During this process it is possible that the previous program sequences, the parameters and the settings in the internal memory could be overwritten!

**9.4.2 Reset**



Pressing for 1...3 seconds displays OFF.

When the button is released the unit has been reset.

**Tab. AC**

**NOTE:**

For the meaning of the diagnostic codes and errors, see the chapter "List of error codes with operation using AZL21... Display" on page 63.

### 10 List of parameters PME71.901...

The following pages have the Menus and the list of parameters for setting up the LCD AZL 2... Display for the LME 71... control box with PME 71.901...

The values shown in the "Factory setting" column, in the table below, are only given as a guide (Control box not programmed).

Parameter		Modification	Values interval		Resolution	Factory setting	Password reading level to level	Password writing level to level
Nr.	Description		Min.	Max.				
<b>000</b>	<b>Internal parameter</b>							
41	Password for heating engineering (4 characters)	Modification	xxxx	xxxx	---	---	---	OEM
42	Password OEM (5 characters)	Modification	xxxxx	xxxxx	---	---	---	OEM
60	Backup/Restore	Modification	Restore	Backup	---	---	---	SO
<b>100</b>	<b>General notes</b>							
102	Identification date	Reading only	---	---	---	---	Info	---
103	Identification number	Reading only	0	9999	1	0	Info	---
113	Burner identification	Modification	x	xxxxxxx	1	burnErlId	Info	SO
123	Step control min output.	Modification	1%	10%	0.1	2	SO	SO
140	Displaying the unit operation mode and displaying AZL2... 1 = standard (program phase) 2 = flame 1 (QRA.../ION) 3 = flame 2 (QRB.../QRC...) @ not used 4 = output active (output value)	Modification	1	4	1	4	SO	SO
164	Number of resettable start-ups	Resettable	0	999999	1	0	Info	Info
166	Total number of start-ups	Reading only	0	999999	1	0	Info	---
170.00	Switching cycles relay contact K12	Reading only	0	999999	1	0	Info	---
170.01	Switching cycles relay contact K11	Reading only	0	999999	1	0	Info	---
170.02	Switching cycles relay contact K2	Reading only	0	999999	1	0	Info	---
170.03	Switching cycles relay contact K1	Reading only	0	999999	1	0	Info	---
171	Max. relay commutation cycles	Reading only	0	999999	1	0	Info	---
<b>200</b>	<b>Burner Control</b>							
224	Air pressure switch special time	Modification	0s	13.818 s	0.294 s	13.818 s	SO	OEM
225	Pre-purging time - 2.1 seconds	Modification	0s	1237 s	4.851 s	29.106 s	SO	OEM
226	Spark pre-ignition time	Modification	1.029 s	37.485 s	0.147 s	6.174 s	SO	OEM
230	Interval: End of the safety time - resetting of the load regulator	Modification	3.234 s	74.97 s	0.294 s	9.408 s	SO	OEM
234	Post-purging time	Modification	0s	1237 s	4.851 s	19.404 s	SO	OEM
235	Air pressure switch input 0 = inactive 1 = active	Modification	0	1	1	0	SO	OEM
240.00	Repetitions meter Limit value of flame loss during operation	Modification	0	2	1	0	SO	OEM
240.01	Repetitions meter Limit value of No flame at the end of the safety time	Modification	0	1	1	1	SO	OEM
241.00	Valves Seal Control 0 = OFF 1 = ON	Modification	0	1	1	1	SO	OEM
241.01	Valves Seal Control 0 = during pre-purging 1 = during post-purging	Modification	0	1	1	1	SO	OEM
241.02	Valves Seal Control 0 = according to P241.01 1 = during pre-purging and post-purging	Modification	0	1	1	0	SO	OEM
242	Evacuation of valve seal control test area	Modification	0s	2.648 s	0.147 s	2.648 s	SO	OEM
243	Atmospheric pressure valve seal control time test	Modification	1.029 s	37.485 s	0.147 s	10.290 s	SO	OEM
244	Filling the valve seal control test area	Modification	0s	2.648 s	0.147 s	2.648 s	SO	OEM
245	Gas pressure valve seal control time test	Modification	1.029 s	37.485 s	0.147 s	10.290 s	SO	OEM
257	Post-ignition time -0,3 seconds	Modification	0s	13.23 s	0.147 s	2.205 s	SO	OEM
<b>400</b>	<b>Ratio control (operation)</b>							
403.00	Fan speed: Ignition load speed (P0)	Modification	800 rpm	900 rpm	10 rpm	3000 rpm	SO	SO
403.01	Fan speed: Low flame speed (P1)	Modification	800 rpm	900 rpm	10 rpm	1200 rpm	SO	SO
403.02	Fan speed: High flame speed (P2)	Modification	800 rpm	900 rpm	10 rpm	5700 rpm	SO	SO
<b>500</b>	<b>Ratio control</b>							
503.00	Speed without PWM fan flame: Standby speed	Modification	0 rpm	9000 rpm	10 rpm	0 rpm	SO	SO

Parameter		Modification	Values interval		Resolution	Factory setting	Password reading level to level	Password writing level to level
Nr.	Description		Min.	Max.				
503.01	Speed without PWM fan flame: Speed of impurity purge	Modification	800 rpm	9000 rpm	10 rpm	5700 rpm	SO	SO
516.00	Limit of ignition load speed (P0): Minimum limit	Modification	800 rpm	9000 rpm	10 rpm	800 rpm	SO	OEM
516.01	Limit of ignition load speed (P0): Maximum limit	Modification	800 rpm	9000 rpm	10 rpm	9000 rpm	SO	OEM
517.00	Limit of low flame speed (P1): Minimum limit Modification	Modification	800 rpm	9000 rpm	10 rpm	800 rpm	SO	OEM
517.01	Limit of low flame speed P1: Maximum limit	Modification	800 rpm	9000 rpm	10 rpm	9000 rpm	SO	OEM
518.00	Limit of high flame speed P2: Minimum limit	Modification	800 rpm	9000 rpm	10 rpm	800 rpm	SO	OEM
518.01	Limit of high flame speed P2: Maximum limit	Modification	800 rpm	9000 rpm	10 rpm	9000 rpm	SO	OEM
519	Maximum fan speed	Modification	3000 rpm	9000 rpm	10 rpm	5830 rpm	SO	OEM
522	Low flame acceleration @ high flame	Modification	2,058 s	74.970 s	0.294 s	14,994 s	SO	OEM
523	High flame acceleration @ low flame	Modification	2,058 s	74.970 s	0.294 s	14,994 s	SO	OEM
558	Mode: Information UDS status 0 = PC tool mode 1 = PWM mode 2 = actuator mode 3 = internally 4 = internally 5 = internally	Reading only	0	5	1	0	SO	---
559	PWM mode 0 = open loop control 1 = PID control 2 = safety mode (PWM limits)	Modification	0	2	1	1	SO	OEM
560	Mode: Control of pneumatic ratio 0 = OFF 1 = PWM fan 2 = air damper actuator	Reading only	0	2	1	1	SO	---
<b>600</b>	<b>Output setting</b>							
644	Number of pulses for rotation	Modification	2	5	1	3	SO	OEM
646	Time of speed control adjustment	Modification	1.029 s	2,058 s	0.147 s	2,058 s	SO	OEM
650.00	Speed tolerance range: Stopping speed	Modification	1%	5%	1%	1%	SO	OEM
650.01	Speed tolerance range: Rapid stopping speed	Modification	1%	10%	1%	3%	SO	OEM
654	Analogue input (feedback potentiometer ASZxx.3x required) 0 = input passage 3 positions 1 = 0...10 V 2 = 0...135 Ω 3 = 0...20 mA 4 = 4...20 mA with lockout at I <4 mA 5 = 4...20 mA	Modification	0	5	1	1	SO	SO
658.00	PWM fan values: PWM starting	Modification	1%	100%	1%	25%	SO	OEM
658.01	PWM fan values: Min. operating interval PWM	Modification	0%	20%	1%	0%	SO	OEM
658.02	PWM fan values: Max. operating interval. PWM	Modification	80%	100%	1%	100%	SO	OEM
659.00	Ramp time of fan: Min. low-fire to high-fire	Reading only	0s	74.970 s	0.294 s	2,058 s	SO	---
659.01	Ramp time of fan: Max. from high flame to low flame	Reading only	0s	74.970 s	0.294 s	74.970 s	SO	---
659.02	Ramp time of fan: Min. high-fire to low-fire	Reading only	0s	74.970 s	0.294 s	2,058 s	SO	---
659.03	Ramp time of fan: Max. high-fire to low-fire	Reading only	0s	74.970 s	0.294 s	74.970 s	SO	---
660	Tolerance time speed deviation	Reading only	0s	37.85 s	0.147 s	4.998 s	SO	---
674	Neutral interval (control offset permitted)	Modification	0 rpm	255 rpm	1 rpm	40 rpm	SO	OEM
675.00	PWM: Min. PWM with pre-purging, SEC	Modification	0%	100%	1%	86%	SO	OEM
675.01	PWM: Max. PWM with ignition load, SEC	Modification	0%	100%	1%	34%	SO	OEM
676	Gain factor speed control	Reading only	0	255	1	112	SO	---
677	Integral action time speed control	Reading only	0s	37.485 s	0.147 s	0.441 s	SO	---
678	Derivative action time speed control	Reading only	0s	37.485 s	0.147 s	0s	SO	---
679.00	Constant time speed control PT1: Min. speed interval from high flame to low flame	Modification	0s	37.485 s	0.147 s	6,027 s	SO	OEM
679.01	Constant time speed control PT1: Average speed interval from high flame to low flame	Modification	0s	37.485 s	0.147 s	6,027 s	SO	OEM
679.02	Constant time speed control PT1: Upper speed interval from high flame to low flame	Modification	0s	37.485 s	0.147 s	6,027 s	SO	OEM
679.03	Constant time speed control PT1: Total speed interval from high flame to low flame	Modification	0s	37.485 s	0.147 s	6,027 s	SO	OEM

Parameter		Modification	Values interval		Resolution	Factory setting	Password reading level to level	Password writing level to level
Nr.	Description		Min.	Max.				
680.00	Speed interval for constant time PT1: Upper speed interval threshold	Modification	800 rpm	9000 rpm	10 rpm	4000 rpm	SO	OEM
680.01	Speed interval for constant time PT1: Lower speed interval threshold	Modification	800 rpm	9000 rpm	10 rpm	2000 rpm	SO	OEM
<b>700</b>	<b>Error history</b>							
701.00	Current error: Error code	Reading only	2	255	1	---	Service	---
701.01	Current error: Start-up meter reading	Reading only	0	999999	1	---	Service	---
701.02	Current error: MMI phase	Reading only	---	---	---	---	Service	---
701.03	Current error: Power value	Reading only	0%	100%	1	---	Service	---
702.00	Error history former 1: Error code	Reading only	2	255	1	---	Service	---
702.01	Error history o1: Start-up meter reading	Reading only	0	999999	1	---	Service	---
702.02	Error history o1: MMI phase	Reading only	---	---	---	---	Service	---
702.03	Error history o1: Power value	Reading only	0%	100%	1	---	Service	---
.								
.								
.								
711.00	Error history former 10: Error code	Reading only	2	255	1	---	Service	---
711.01	Error history former 10: Start-up meter reading	Reading only	0	999999	1	---	Service	---
711.02	Error history former 10: MMI phase	Reading only	---	---	---	---	Service	---
711.03	Error history former 10: Power value	Reading only	0%	100%	1	---	Service	---
<b>900</b>	<b>Process data</b>							
920	Current PWM signal fan	Reading only	0%	100%	1%	---	Service	---
936	Normalized speed	Reading only	0%	100%	0.01%	---	Service	---
951	Mains voltage	Reading only	0 V	LME 71.000 A1: 175 V LME 71.000 A2: 350 V	1 V	---	Service	---
954	Flame intensity	Reading only	0%	100%	1%	---	Service	---

Tab. AD



## A Appendix - Accessories

### Output power regulator kit for modulating operation

With the modulating operation, the burner continually adapts the power to the heat request, ensuring a high level of stability for the parameter controlled: temperature or pressure.

Two components should be ordered:

- the output power regulator to be installed on the burner;
- the probe to install on the heat generator.

Burner	Output regulator	Code
RX 700-850-1000S/PV	RWF50.2	20094733

Burner	Probe	Adjustment field	Code
RX 700-850-1000S/PV	Temperature PT 100	- 100 ÷ 500° C	3010110
	Pressure 4 ÷ 20 mA	0 ÷ 2,5 bar	3010213
	Pressure 4 ÷ 20 mA	0 ÷ 16 bar	3010214
	Pressure 4 ÷ 20 mA	0 ÷ 25 bar	3090873

### Software diagnostics kit

A special kit is available that, by an optical link to a PC, shows the burner life together with operating hours, type and number of lockouts, number of motor rpm's and safety parameters.

To view diagnostics, proceed as follows:

- connect the kit (supplied separately) to the appropriate socket on the control box. Reading of the information begins when the software programme included in the kit starts.



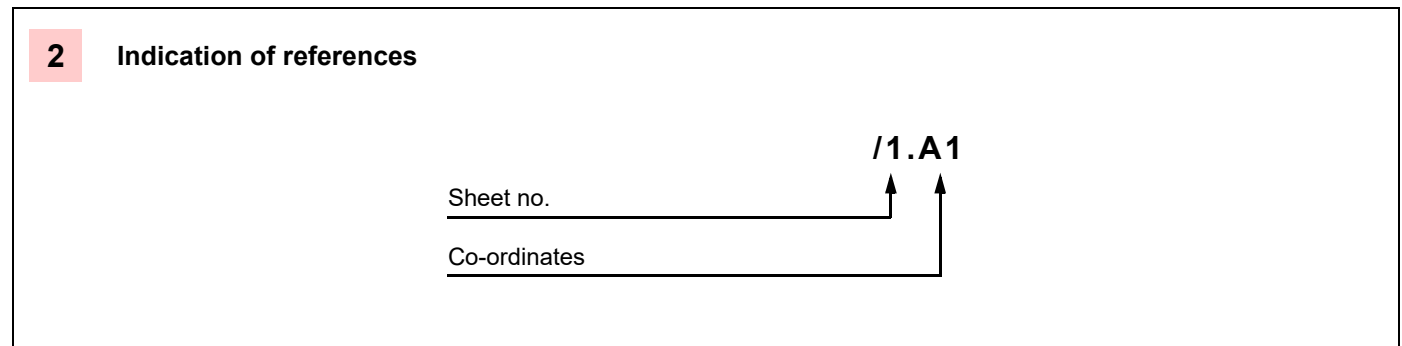
**WARNING**

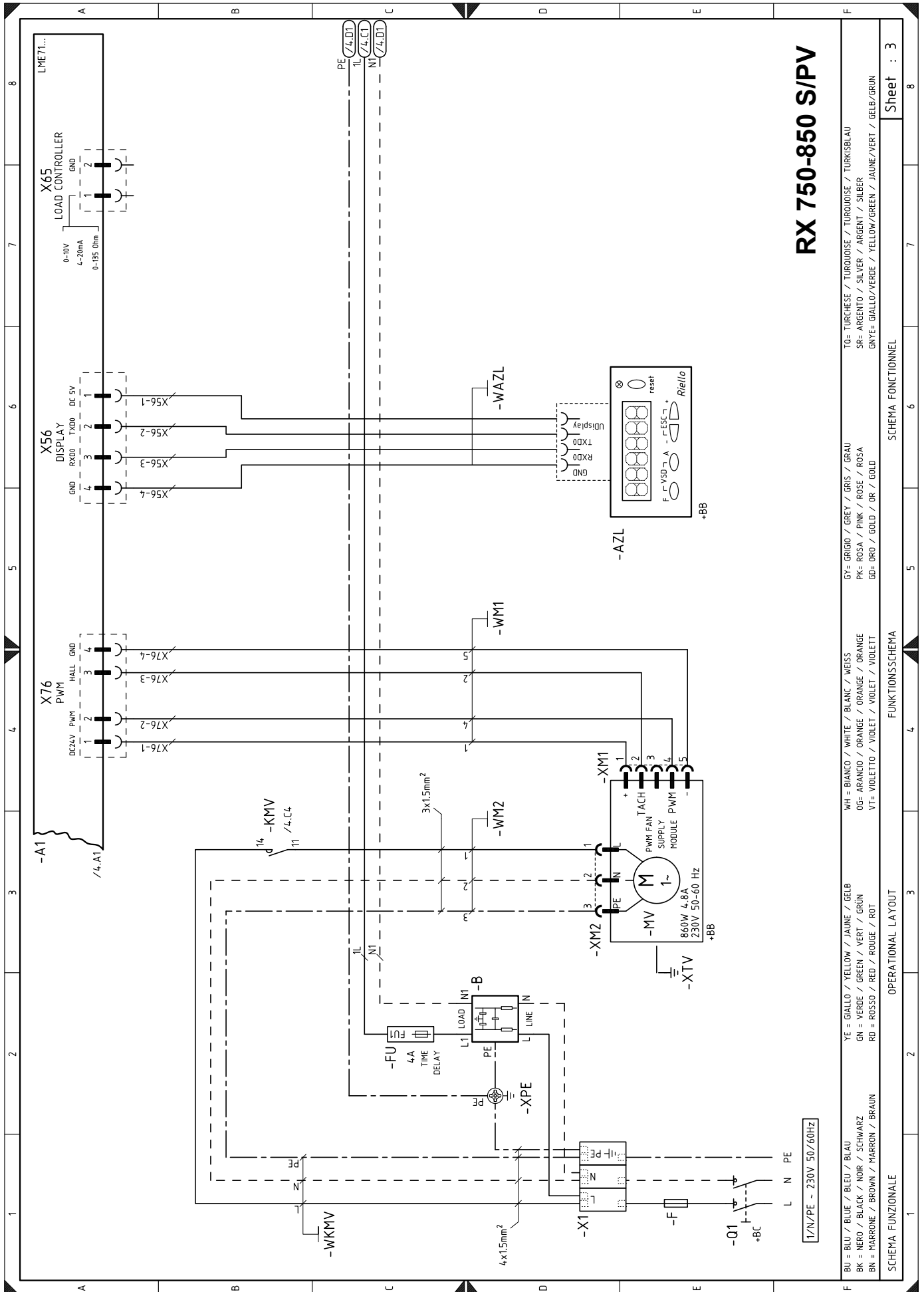
The installer is responsible for the addition of any safety device not foreseen in this manual.

Burner	Code
RX 700-850-1000S/PV	on demand

**B Appendix - Electrical panel layout**

<b>1</b>	<b>Index of layouts</b>
<b>2</b>	Indication of references
<b>3</b>	Operational layout
<b>4</b>	Operational layout
<b>5</b>	Operational layout
<b>6</b>	Operational layout
<b>7</b>	Electrical wiring set by installer
<b>8</b>	Electrical wiring set by installer
<b>9</b>	RWF50... operational layout





**RX 750-850 S/PV**

1/1N/PE ~ 230V 50/60Hz

RU = BLU / BLEU / BLAU  
 BK = NERO / BLACK / NOIR / SCHWARZ  
 BN = MARRONE / BROWN / MARRON / BRAUN

YE = GIALLO / YELLOW / JAUNE / GELB  
 GN = VERDE / GREEN / VERT / GRÜN  
 RD = ROSSO / RED / ROUGE / ROT

WH = BIANCO / WHITE / BLANC / WEISS  
 OG = ARANCIO / ORANGE / ORANGE / ORANGE  
 VT = VIOLETO / VIOLET / VIOLET / VIOLETT

GY = GRIGIO / GREY / GRIS / GRAU  
 PK = ROSA / PINK / ROSE / ROSA  
 GD = ORO / GOLD / OR / GOLD

TO = TURCHESE / TURQUOISE / TURQUOISE / TURKISBLAU  
 SR = ARGENTO / SILVER / ARGENT / SILBER  
 GNTE = GIALLO/VERDE / YELLOW/GREEN / JAUNE/VERT / GELB/GRÜN

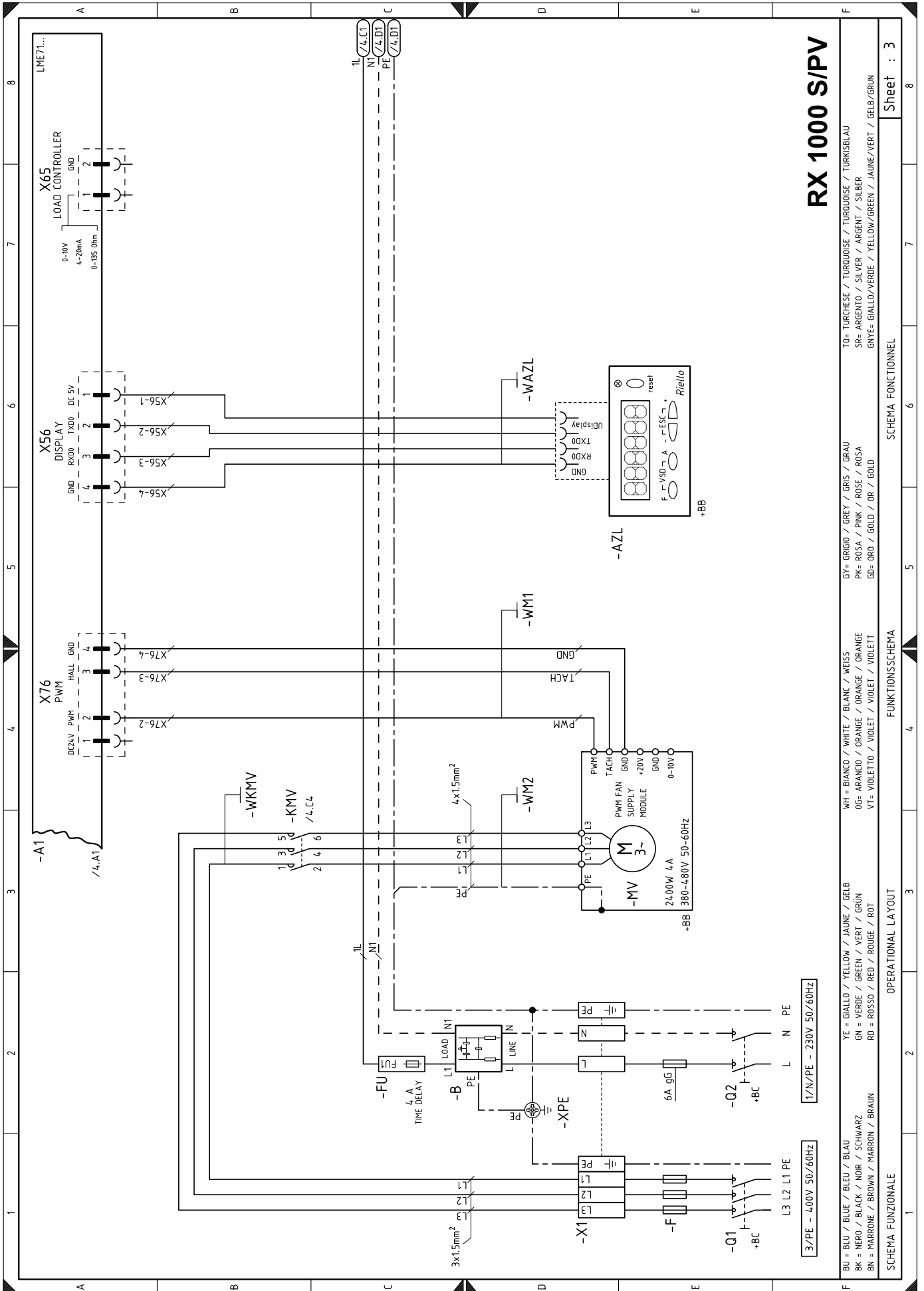
SCHEMA FUNZIONALE

OPERATIONAL LAYOUT

FUNKTIONSSCHEMA

SCHEMA FONCTIONNEL

Sheet : 3



**RX 1000 S/PV**

TO= TURCHESE / TURDOUISE / TURKISBLAU  
 SR= ARGENTO / SILVER / ARGENT / SILBER  
 GNYE= GIALLO/VERDE / YELLOW/GREEN / JAUNE/VERT / GELB/GRUN

GY= GRIGIO / GREY / GRIS / GRAU  
 PK= ROSA / PINK / ROSE / ROSA  
 GD= ORO / GOLD / OR / GOLD

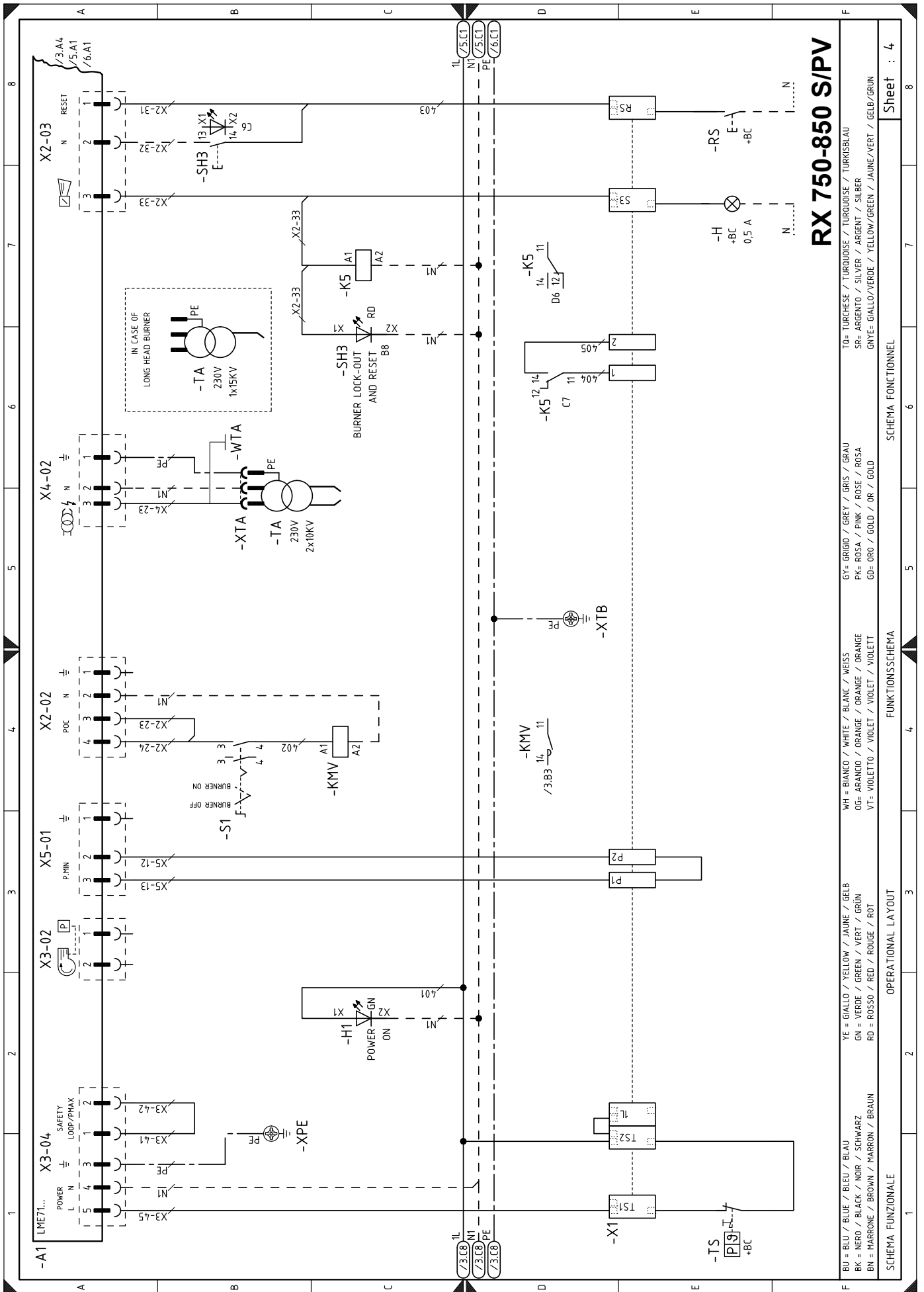
WH= BIANCO / WHITE / BLANC / WEISS  
 OG= ARANCIO / ORANGE / ORANGE / ORANGE  
 VT= VIOLETTA / VIOLET / VIOLET / VIOLETT

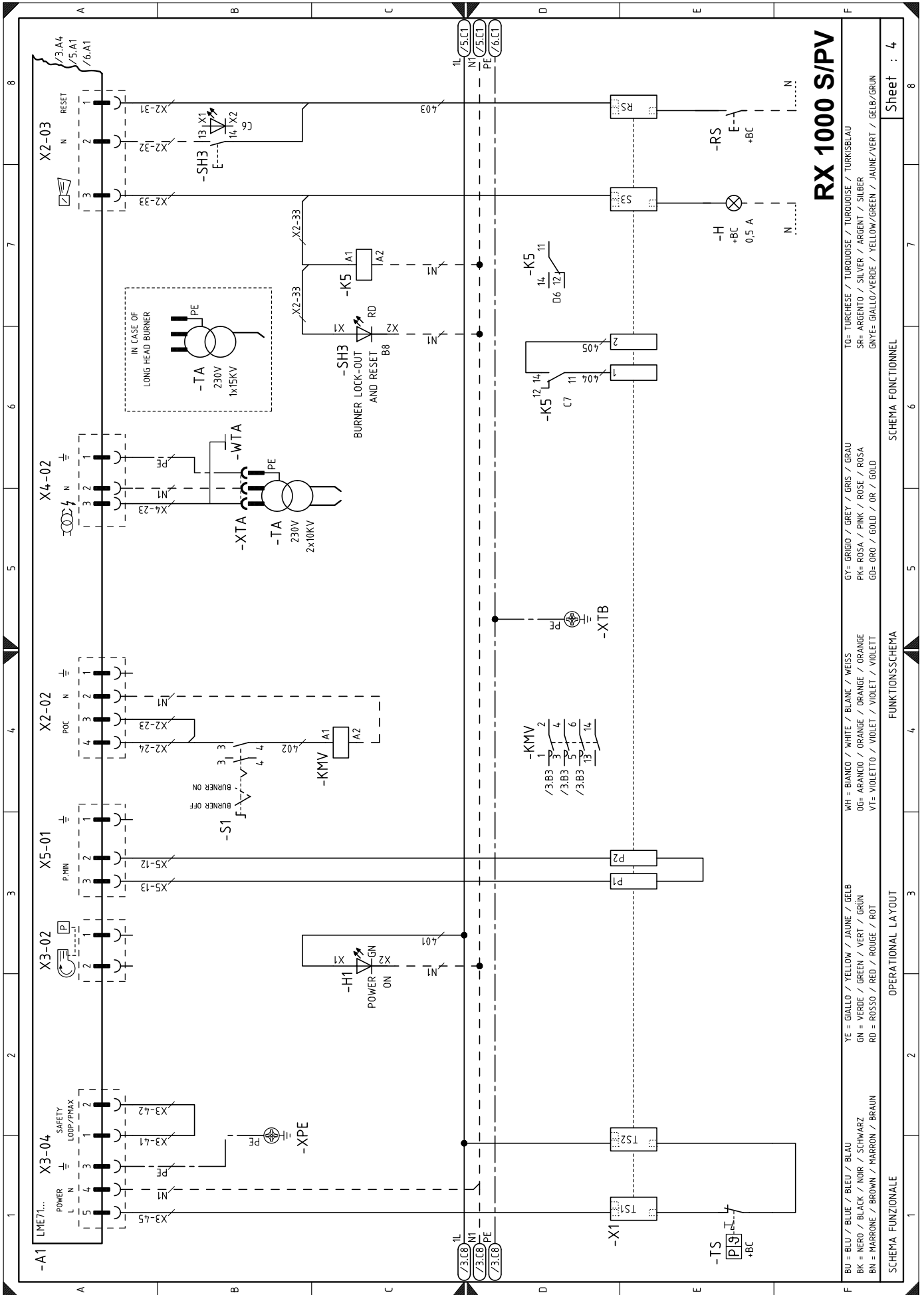
YE = GIALLO / YELLOW / JAUNE / GELB  
 GN = VERDE / GREEN / VERT / GRUN  
 RD = ROSSO / RED / ROUGE / ROT

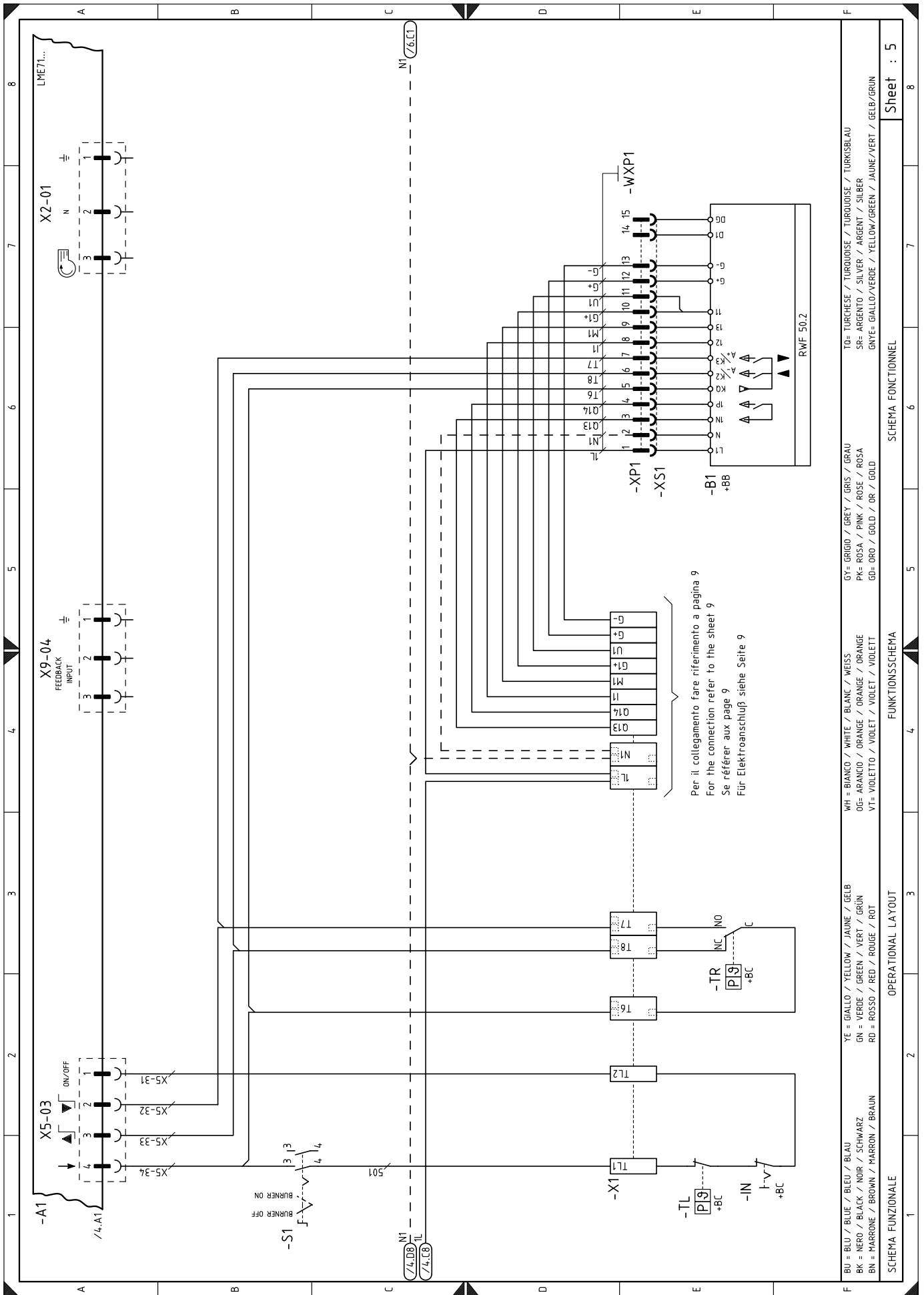
BU = BLU / BLUE / BLEU / BLAU  
 BK = NERO / BLACK / NOIR / SCHWARZ  
 BN = MARRONE / BROWN / MARRON / BRAUN

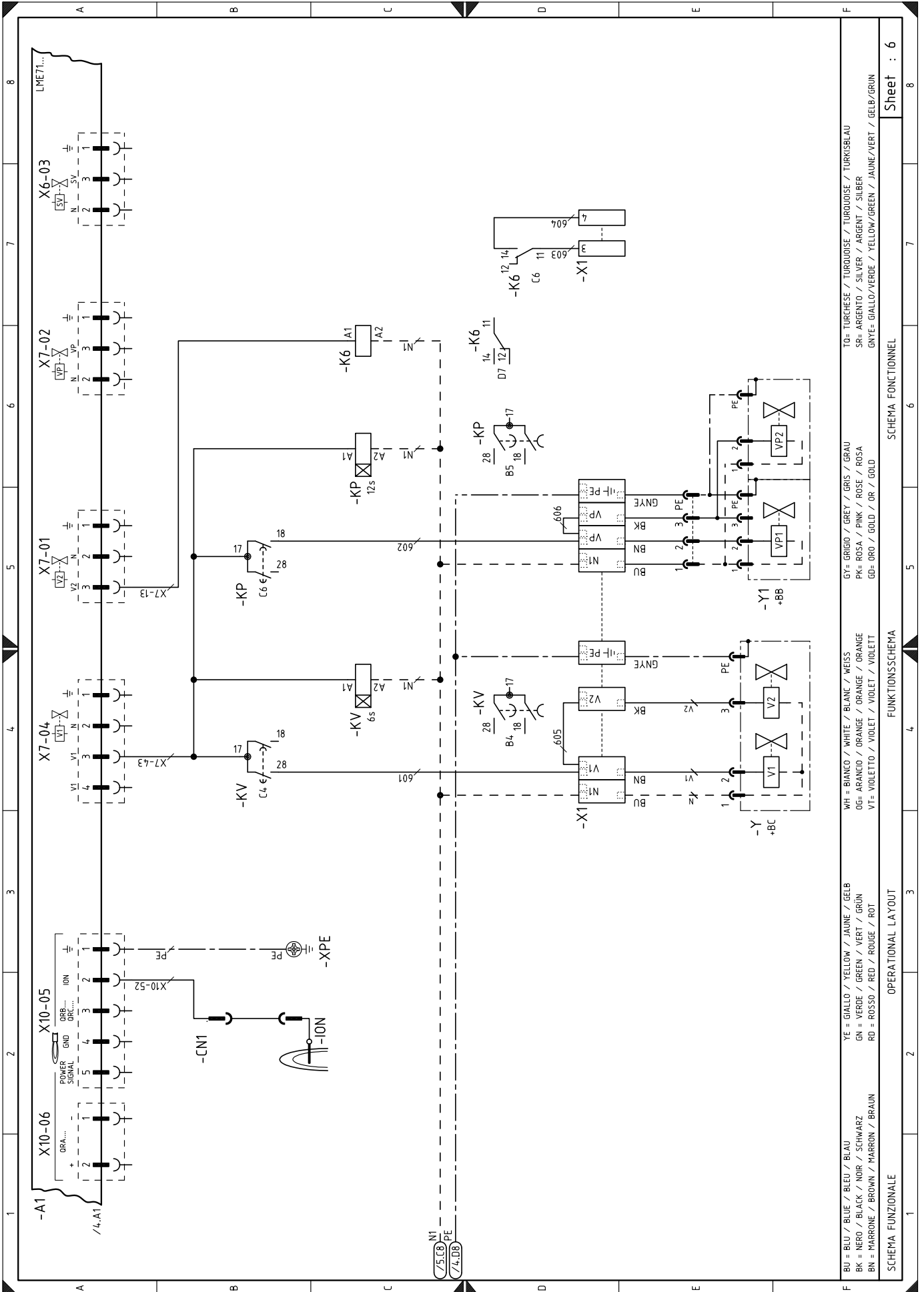
SCHEMA FUNZIONALE  
 SCHEMA FONCTIONNEL  
 OPERATIONAL LAYOUT  
 FUNKTIONSSCHEMA

Sheet : 3

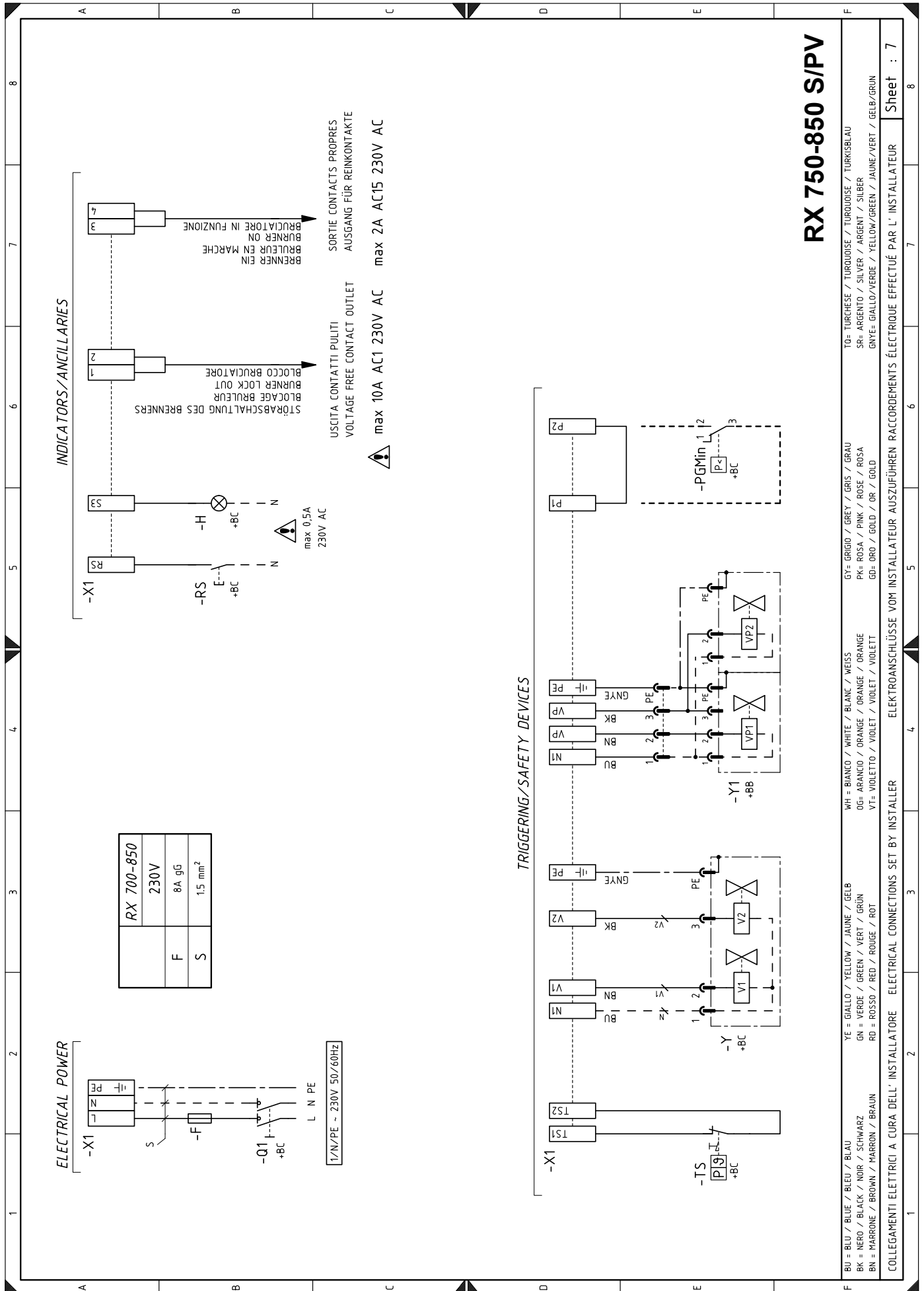










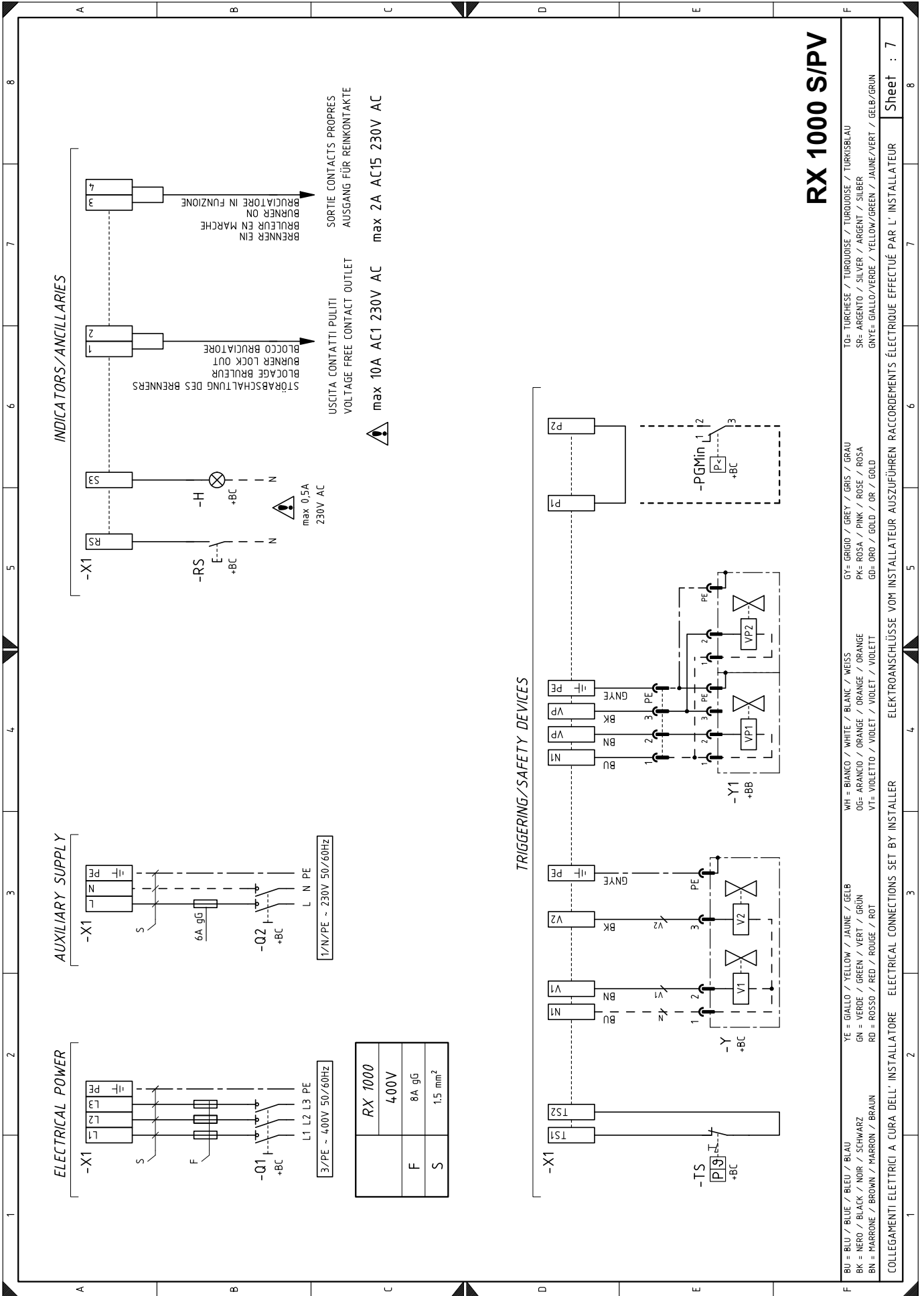


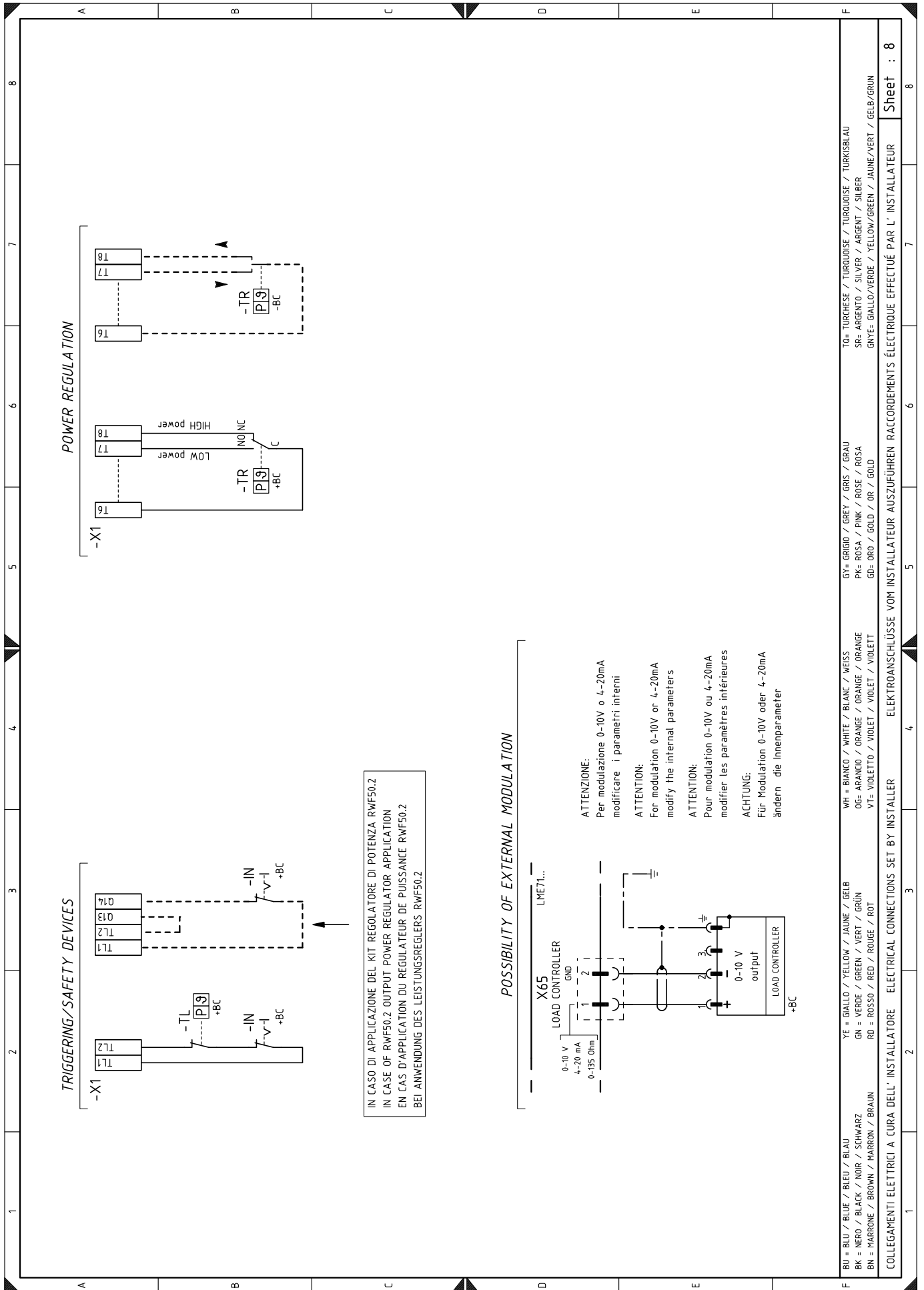
# RX 750-850 S/PV

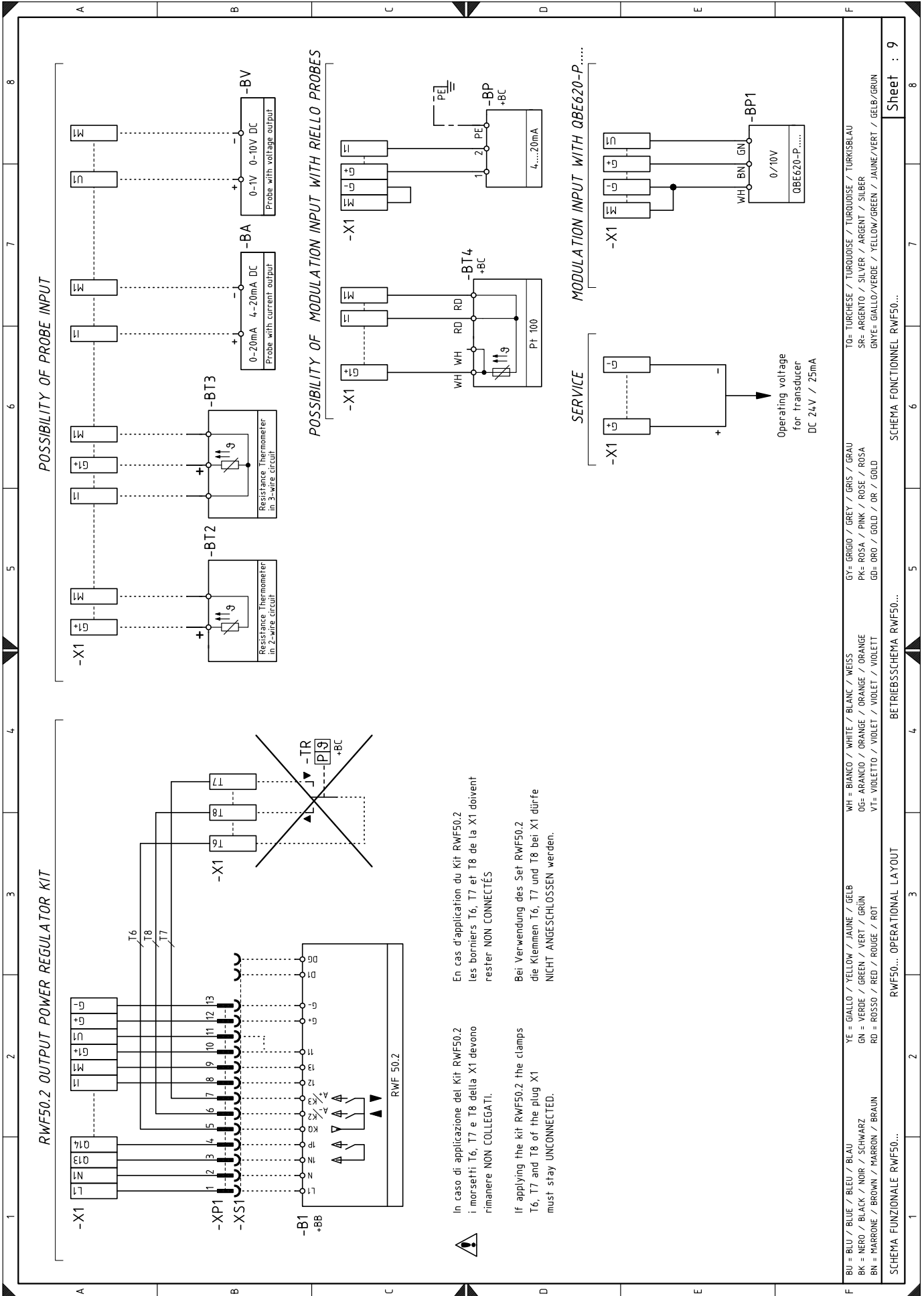
BU = BLU / BLUE / BLEU / BLAU	WH = BIANCO / WHITE / BLANC / WEISS	GY = GRIGIO / GREY / GRIS / GRAU	TO = TURCHESE / TURQUOISE / TURKOISE / TURKISBLAU
BK = NERO / BLACK / NOIR / SCHWARZ	OG = ARANCIO / ORANGE / ORANGE / ORANGE	PK = ROSA / PINK / ROSE / ROSA	SR = ARGENTO / SILVER / ARGENT / SILBER
BN = MARRONE / BROWN / MARRON / BRAUN	VT = VIOLETTO / VIOLET / VIOLET / VIOLETT	GD = ORO / GOLD / OR / GOLD	GN = GIALLO/VERDE / YELLOW/GREEN / JAUNE/VERT / GELB/GRÜN
YE = GIALLO / YELLOW / JAUNE / GELB	GN = VERDE / GREEN / VERT / GRÜN	RD = ROSSO / RED / ROUGE / ROT	GN+ = GIALLO/VERDE / YELLOW/GREEN / JAUNE/VERT / GELB/GRÜN

COLLEGAMENTI ELETTRICI A CURA DELL'INSTALLATORE    ELECTRICAL CONNECTIONS SET BY INSTALLER    ELEKTROANSCHLÜSSE VOM INSTALLATEUR AUSZUFÜHREN    RACCORDEMENTS ÉLECTRIQUE EFFECTUÉ PAR L'INSTALLATEUR

Sheet : 7







**Wiring layout key**

+BB	Components on burner
+BC	Components on boiler
A1	Control box LME7...
AZL	Display and operating unit
B	Suppressor
BA	Input under current 4...20 mA DC
BP	Pressure probe
BP1	Pressure probe
BT2	Probe Pt100 with 2 wires
BT3	Probe Pt100 with 3 wires
BT4	Probe Pt100 with 3 wires
BV	Probe with voltage output
B1	Internal output power regulator RWF50.2
CN1	Ionisation probe connector
F	Fuse
FU	Control box fuse
H	Lock-out signal burner external
H1	Signal light for burner on
KMV	Fan motor contactor/relay
KP	Timer for pilot valve
KV	Timer for main valve
K5	Burner lock-out voltage free contact relay
K6	Fuelled burner ON clean contacts output relay
ION	Ionisation probe
MV	Fan motor
PGMin	Minimum gas pressure switch
Q1	Main switch
Q2	Auxiliary switches
RS	Reset button external burner
SH3	Burner reset button and lockout warning
S1	Burner switch ON/OFF
TA	Ignition transformer
TL	Limit thermostat/pressure switch
TR	Safety thermostat/pressure
TS	Adjustment thermostat/pressure
V1	Gas valve 1
V2	Gas valve 2
VP1	Pilot gas valve
VP2	Pilot gas valve
X...	Control box connectors
X1	Main supply terminal strip
XM...	Fan motor connectors
XTB	Burner earth
XPE...	Main earth
XP1	RWF50.2 kit socket
XRWF	Output power regulator RWF50.2 terminal strip
XTA	Earth transformer
XTV	Fan earth
Y	Main gas train
Y1	Pilot gas train





---

**RIELLO**

RIELLO S.p.A.  
I-37045 Legnago (VR)  
Tel.: +39.0442.630111  
[http:// www.riello.it](http://www.riello.it)  
[http:// www.riello.com](http://www.riello.com)